



AKKO®



2024 KATALOĞU CATALOGUE KATALOG

TÜRKÇE • ENGLISH • DEUTSCH

versiyon **20-1**
version
auflage

Değiştirilebilir Uçlu Takımlar, Takım Tutucu Sistemler ve Kesici Uçlar
Indexable Tools, Tool Holder Systems and Cutting Inserts
Zerspanungswerkzeuge, Werkzeugaufnahmen und Zerspanungswerkzeuge

*konuşulan kalite...
the spoken quality...
qualität über die man spricht...*



    AKKO Metalworking Tools

 www.akko.com.tr

konuşulan
the spoken kalite...
quality...







1986 yılında Abdullah KARAKUŞ tarafından kurulan AKKO Makina Sanayi ve Ticaret A.Ş. Tornalama Takımları, Diş ve Kanal Açma Takımları, Delik Delme Takımları, Frezeleme Takımları ve talebe yönelik Özel Takımlar, Monoblok ve Tutucular ile Profil Uçlar üretmektedir. Şu an 40.000m²'ye yakın bir alanda Türkiye, Japonya, Almanya, İsviçre gibi ülkelerin ürettikleri son teknoloji tezgah ve ekipmanlarıyla yıllık 750.000 adet üretim kapasitesiyle, standart 10.000 çeşit takım üretimi ve 70.000 adet profil uç üretimi yapmaktadır. Avrupa, Asya, Afrika, Güney Amerika, Kuzey Amerika ve Orta Doğu kıtalarında şimdilik düzenli olarak 90 ülkeye ürün sevkiyatına devam etmektedir. Minimum 300.000 adet üretilmiş ürün stoklarında mevcut bulunmaktadır. Firma için özel üretilen çelik hammadde işleme girer ve bütün üretim süreci kendi bünyesinde gerçekleşmektedir. Çeliğin işlenmesi, ısıl işlemleri, üzerindeki kaplama ve her türlü üretim operasyonları bir entegre tesis olan AKKO'da yapılmaktadır.

We as AKKO Makina Sanayi ve Ticaret A.Ş. which were founded by Abdullah KARAKUŞ in 1986, produce Turning Tool Holders, Threading and Grooving Tool Holders, U-Drills, Milling Tool Holders, Precision Tool Holders (OEM Tool Holders) on-demand, Monoblocks and Holders, and Profile Inserts. We produce a standard 10.000 kinds of tool holders with a production capacity of 750.000 pieces and 70.000 pieces of special profile inserts per year in an area of about 40.000 square meters. We are going on regularly exporting to 90 countries including European, Asian, African, South American Countries, North American Countries, and Middle Eastern countries. We keep ready about 300.000 pieces produced products in our stock. Steel Raw materials that we make produced especially for us are delivered our factory and all production process are made in our factory. All kinds of operations from machining of steel to heat treatment and coating on our tools are made in our integrated factory AKKO.

Wir die Firma AKKO Makina Sanayi ve Ticaret A.Ş. welches durch Herrn Abdullah Karakuş in 1986 gegründet wurde, produzieren Dreh-, Gewinde- und Stechwerkzeuge für Wendeschneidplatten. Zum Lieferprogramm gehören außerdem Wendeplattenbohrer, Wendeplattenfräser, Halter und auf Anfrage auch Sonderwerkzeuge für Wendeschneidplatten. Alle Werkzeuge sind auch als OEM-Version lieferbar. Wir produzieren 10.000 Standard Arten der Werkzeughalter mit einer Produktionskapazität von 750.000 Stücken und 70.000 Stück Spezialprofileinlagen per annum auf einer Fläche von 40.000 Quadrat Meter. Wir exportieren unsere eigenproduzierten Ware nach 90 Ländern, Europa, Asien, Afrika, Süd amerikanische Länder, Mittlerer Osten. Lieferbereit halten wir 300.000 Stück produzierte Produkte auf Lager. Das eingesetzte Rohmaterial wird speziell für unsere Firma produziert. Alle Produktionsschritte werden auf unseren eigenen Anlagen veranlasst. Alle einzelnen Produktionsschritte wie z.B. mechanische Bearbeitung, Wärmebehandlung und Beschichtung unserer Werkzeuge erfolgen auf unseren eigenen Maschinenanlagen.

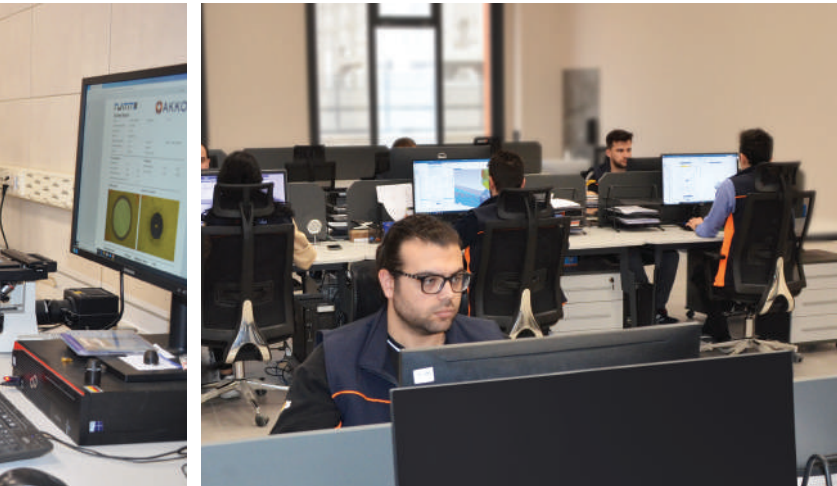

S11 S12-17	POLİGONAL ŞAFTLI YEKPARE TAKIMLAR POLİGONAL ŞAFTLI YEKPARE TAKIMLAR KODLAMA SİSTEMİ POLİGONAL ŞAFTLI YEKPARE TAKIMLAR
S19 S20-35 S38-39 S41-51 S52-58 S61-72 S73-78 S79-81	DIŞ TORNA TAKIMLARI DIŞ TORNA KATERLERİ KODLAMA SİSTEMİ T-SİSTEM DIŞ TORNA KATERLERİ M-SİSTEM DIŞ TORNA KATERLERİ P-SİSTEM DIŞ TORNA KATERLERİ C-SİSTEM DIŞ TORNA KATERLERİ S-SİSTEM DIŞ TORNA KATERLERİ S-SİSTEM İSVİÇRE TİPİ KAYAR OTOMAT MAKİNA TAKIMLARI KOLAY DEĞİŞTİRİLEBİLİR İSVİÇRE TİPİ KAYAR OTOMAT MAKİNA TAKIMLARI
S83 S84-90 S92-95 S96-102 S104-120	DELİK TORNA TAKIMLARI DELİK TORNA KATERLERİ KODLAMA SİSTEMİ T&C SİSTEM DELİK TORNA KATERLERİ M-SİSTEM DELİK TORNA KATERLERİ P-SİSTEM DELİK TORNA KATERLERİ S-SİSTEM DELİK TORNA KATERLERİ
S122 S123-129	TIRLAMAZ TAKIMLAR-ANTI VIBRATION TOOLS TIRLAMAZ TAKIMLARIN KODLAMA SİSTEMİ TIRLAMAZ TAKIMLAR
S132 S133-135 S135-139 S140-143	KARTUŞLAR KARTUŞLARIN KODLAMA SİSTEMİ S-TİP RİKTEFİYE KARTUŞLARI S-SİSTEM KARTUŞLAR P-SİSTEM KARTUŞLAR VE BORU PAHLAMA TAKIMLARI
S145 S146-151	DIŞ AÇMA TAKIMLARI DIŞ AÇMA KATERLERİ KODLAMA SİSTEMİ DIŞ AÇMA KATERLERİ ve TEKNİK BİLGİ
S152-203 S153	KANAL AÇMA TAKIMLARI KANAL KATERLERİ KODLAMA SİSTEMİ DIŞ ÇAP KANAL AÇMA TAKIMLARI DIŞ ÇAP KANAL AÇMA İSVİÇRE TİPİ KAYAR OTOMAT MAKİNA TAKIMLARI DIŞ ÇAP ALIN KANAL AÇMA TAKIMLARI L TİP ALIN KANAL AÇMA TAKIMLARI KESME VE DERİN KANAL AÇMA LAMALARI KESME VE DERİN KANAL AÇMA LAMA BLOĞU DELİK İÇİ KANAL KATERLERİ
S206-261 S207 S210 S211 S212 S244-248 S250	DELİK DELME ve İŞLEME TAKIMLARI TAKMA UÇLU MATKAPLAR ve KODLAMA SİSTEMİ DELİK PAHLAMA TAKIMI ve MONTAJ ŞEKLİ EKSANTRİK TAKMA UÇLU MATKAP ADAPTÖRÜ ÖZEL DELİK DELME ve İŞLEME TAKIMI SİPARİŞ FORMU EKONOMİK KEŞİCİLER ve KODLAMA SİSTEMİ AYARLI DELİK İŞLEME BARALARI ve KODLAMA SİSTEMİ
S262-431 S263	FREZELEME TAKIMLARI FREZELEME TAKIMLARI KODLAMA SİSTEMİ S-SİSTEM PAH FREZELER HELİS PAH FREZELEME TAKIMLARI SİLİNDİRİK ALYAN BAŞLI VİDA (DIN 974-1) HAVŞALARINI AÇMA FREZELERİ S-SİSTEM YÜZEY PARMAK FREZELER S-SİSTEM YÜZEY ve KOPYA PARMAK FREZELER S-SİSTEM HIZLI İLERLEMELİ PARMAK FREZELER S-SİSTEM MODÜLER PARMAK FREZELER S-SİSTEM HIZLI İLERLEMELİ MODÜLER PARMAK FREZELER KÜRE UÇLU PARMAK FREZELER MODÜLER KÜRE UÇLU PARMAK FREZELER VIDALI TAKIM TUTUCULARI DIŞ AÇMA FREZELEME TAKIMLARI S-SİSTEM HELİS FREZELER YÜZEY FREZELER YÜZEY ve KOPYA FREZELER C-SİSTEM YÜZEY FREZELER HIZLI İLERLEMELİ FREZELER T KANAL FREZELER DİSK FREZELER FREZELEME TAKIMLARI MONTAJ ÖLÇÜLERİ ve TEKNİK BİLGİLER
S426-430	
S432-445	YEDEK PARÇALAR YEDEK PARÇALAR

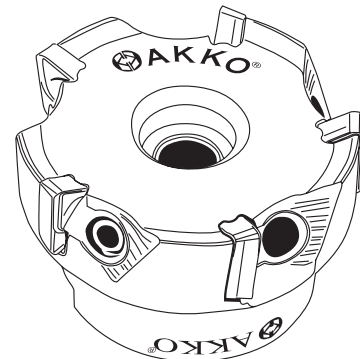
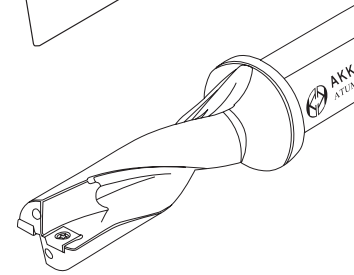
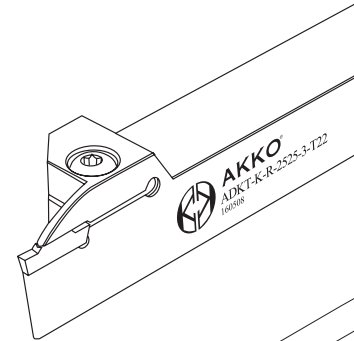
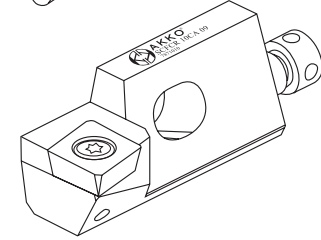
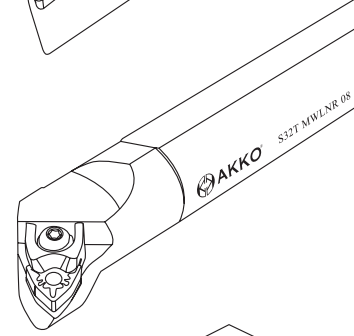
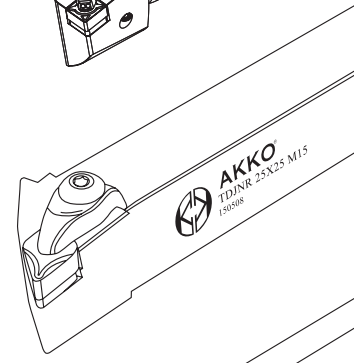
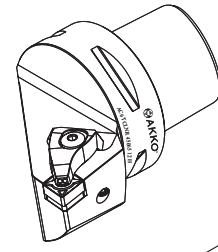

İÇİNDEKİLER

CONTENTS

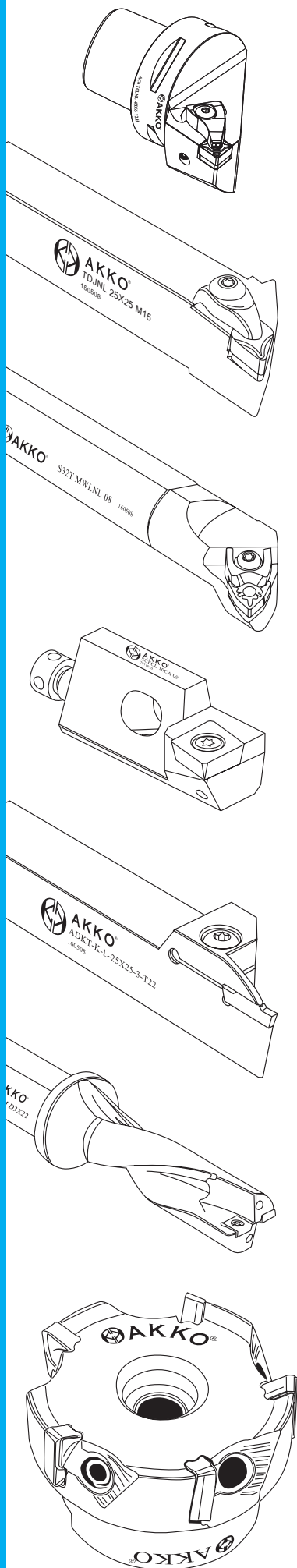

MONOBLOCK TOOLS WITH POLYGONAL SHANK	
MONOBLOCK TOOLS WITH POLYGONAL SHANK DESIGNATION SYSTEM	P11
MONOBLOCK TOOLS WITH POLYGONAL SHANK	P12-17
EXTERNAL TURNING TOOLHOLDERS	
EXTERNAL TURNING TOOLHOLDERS DESIGNATION SYSTEM	P19
T-SYSTEM EXTERNAL TURNING TOOLHOLDERS	P20-35
M-SYSTEM EXTERNAL TURNING TOOLHOLDERS	P38-39
P-SYSTEM EXTERNAL TURNING TOOLHOLDERS	P41-51
C-SYSTEM EXTERNAL TURNING TOOLHOLDERS	P52-58
S-SYSTEM EXTERNAL TURNING TOOLHOLDERS	P61-72
S-SYSTEM TOOLS FOR SWISS TYPE SLIDING AUTOMATIC LATHES	P73-78
SEC TOOLS - SWISS EASY CHANGE	P79-81
INTERNAL TURNING TOOLHOLDERS	
BORING BARS DESIGNATION SYSTEM	P83
T&C SYSTEM BORING BARS	P84 -90
M-SYSTEM BORING BARS	P92 -95
P-SYSTEM BORING BARS	P96 -102
S-SYSTEM BORING BARS	P104-120
ANTIVIBRATION TOOLS	
ANTIVIBRATION TOOL DESIGNATION SYSTEM	P122
ANTIVIBRATION TOOLS	P123-129
CARTRIDGE	
CARTRIDGE DESIGNATION SYSTEM	P132
S-TYPE ENGINE OVERHAUL CARTRIDGE	P133-135
S-SYSTEM CARTRIDGE	P135-139
P-SYSTEM CARTRIDGE AND PIPE BEVELING and CHAMFERING TOOLS	P140-143
THREADING TOOLHOLDERS	
THREADING TOOLHOLDERS DESIGNATION SYSTEM	P145
THREADING TOOLHOLDERS and TECHNICAL INFORMATION	P146-151
GROOVING TOOLHOLDERS	
GROOVING TOOLHOLDERS DESIGNATION SYSTEM	P152-203
EXTERNAL GROOVING TOOLHOLDERS	P153
EXTERNAL GROOVING TOOLHOLDERS FOR SWISS TYPE SLIDING AUTOMATIC LATHES	
EXTERNAL FACE GROOVING TOOLHOLDERS	
L TYPE EXTERNAL FACE GROOVING TOOLHOLDERS	
BLADES FOR PARTING AND DEEP GROOVING	
BLOCKS FOR PARTING AND DEEP GROOVING BLADES	
INTERNAL GROOVING TOOLHOLDERS	
DRILLING and HOLEMAKING TOOLS	
U-DRILL SYSTEM and DESIGNATION SYSTEM	P206-261
DRILL CHAMFERING RING TOOLS AND MOUNTING SYSTEM	P207
EXCENTRIC ADAPTOR FOR U-DRILLS	P210
SPECIAL DRILL ORDER FORM	P211
ECONOMIC CUTTING TOOLS and DESIGNATION SYSTEM	P212
ADJUSTABLE BORING HEADS and DESIGNATION SYSTEM	P244-248
	P250
MILLING TOOLS	
MILLING TOOLS DESIGNATION SYSTEM	S262-431
S-SYSTEM CHAMFERING END MILLS	S263
HELIX CHAMFER MILLING TOOLS	
COUNTERSINK MILLING TOOL FOR CYLINDRICAL ALLEN HEAD SCREWS (DIN 974-1)	
S-SYSTEM END MILLS	
S-SYSTEM FACE and COPY END MILLS	
S-SYSTEM HIGHFEED END MILLS	
S-SYSTEM MODULAR END MILLS (SCREW TYPE TOOLS)	
S-SYSTEM MODULAR (SCREW TYPE) HIGHFEED END MILLS	
BALL NOSE MILLS	
BALL NOSE MODULAR (SCREW TYPE) END MILLS	
SCREWED TOOL HOLDERS	
THREAD MILLING TOOLS	
S-SYSTEM HELIX END MILL	
FACE MILLING	
FACE and COPY MILLING TOOLS	
C-SYSTEM FACE MILLING	
HIGH FEED MILLING TOOLS	
T SLOT MILLING	
DISC MILLING	
MOUNTING REFERENCE FOR MILLING CUTTERS and TECHNICAL INFORMATION	S426-430
SPARE PARTS	
SPARE PARTS	P432-445

S11 S12-17	MONOBLOCKHALTER MIT POLYGONSCHAFT MONOBLOCKHALTER MIT POLYGONSCHAFT BEZEICHNUNGSSYSTEM MONOBLOCKHALTER MIT POLYGONSCHAFT
S19 S20-35 S38-39 S41-51 S52-58 S61-72 S73-78 S79-81	DREHEN - AUßENDREHHALTER BEZEICHNUNGSSCHLÜSSEL FÜR DREHALTER AUßENBEARBEITUNG T-SYSTEM AUßEN - DREHHALTER M-SYSTEM AUßEN - DREHHALTER P SYSTEM AUßEN - DREHHALTER C SYSTEM AUßEN - DREHHALTER S SYSTEM AUßEN - DREHHALTER S-SYSTEM FÜR LANGDREHAUTOMATEN SEC TOOLS
S83 S84-90 S92-95 S96-102 S104-120	DREHWERKZEUGE FÜR DIE INNENBEARBEITUNG BOHRSTANGE BEZEICHNUNGSSYSTEM T&C SYSTEM BOHRSTANGE M-SYSTEM BOHRSTANGE P- SYSTEM BOHRSTANGE S- SYSTEM BOHRSTANGE
S122 S123-129	ANTIVIBRATION TOOLS ANTIVIBRATION TOOL DESIGNATION SYSTEM ANTIVIBRATION TOOLS
S132 S133-135 S135-139 S140-143	KURZDREHHALTER KURZDREHHALTER BEZEICHNUNGSSYSTEM S-SYSTEM KURZDREHHALTER FÜR DIE MOTORINSTANDHALTUNG S-SYSTEM KURZDREHHALTER S-SYSTEM KURZDREHHALTER
S145 S146-151	GEWINDE DREHHALTER GEWINDE DREHHALTER BEZEICHNUNGSSYSTEM AUßEN-GEWINDEDREHHALTER
S152-203 S153	STECHHALTER STECHHALTER BEZEICHNUNGSSYSTEM AUßEN-STECHHALTER WERKZEUGE ZUR STECHBEARBEITUNG AUF LANGDREHAUTOMATEN AXIAL-STECHHALTER AXIAL STECHHALTER L-TYPE STECHSCHWERT FÜR ABSTECHEN UND TIEFE EINSTICHE SPANNBLOCK FÜR STECHSCHWERT INNEN-STECHHALTER
S206-261 S207 S210 S211 S212 S244-248 S250	BOHRWERKZEUGE VOLLBOHRER / BEZEICHNUNGSSYSTEM FÜR VOLLBOHRER FASRING FÜR VOLLBOHRER EXENTRISCHER ADAPTER FÜR WENDEPLATTENBOHRER BESTELLFORMULAR FÜR SONDERBOHRER BEZEICHNUNGSSYSTEM FÜR MULTIFUNKTIONALES DREH-UND BOHRWERKZEUG / BOHREN, INNEN-UND AUßENDREHEN BEZEICHNUNGSSYSTEM FÜR EINSTELLBBARE SPINDELKÖPFE / EINSTELLBARE SPINDELKÖPFE
S262-431 S263	FRÄSWERKZEUGE BEZEICHNUNGSSYSTEM FÜR FRÄSER S-SYSTEM FASFRÄSER HELIX-FASFRÄSER SENKWERKZEUG FÜR ZYLINDERKOPFSCHRAUBEN (DIN 974-1) S-SYSTEM SCHAFTFRÄSER S-SYSTEM KOPIER- UND SCHAFTFRÄSER S-SYSTEM HOCHVORSCHUB- SCHAFTFRÄSER S-SYSTEM EINSCHRAUBFRÄSER S-SYSTEM HOCHVORSCHUB-EINSCHRAUBFRÄSER KUGELKOPIERFRÄSER MODULARE EINSCHRAUB-KUGELFRÄSER AUFNAHME FÜR EINSCHRAUBFRÄSER GEWINDEFÄSERWERKZEUGE S-SYSTEM WENDELSCHAFTFRÄSER PLAN UND ECKMESSERKÖPFE MESSERKÖPFE FÜR RUNDE WENDESCHNEIDPLATTEN PLAN UND ECKMESSERKÖPFE HOCHVORSCHUBFRÄSER T-NUTENFRÄSER SCHEIBENFRÄSER
S426-430	ABMESSUNGEN DER AUFNAHMEBOHRUNGEN FÜR MESSERKÖPFE
S432-445	ERSATZTEILE ERSATZTEILE

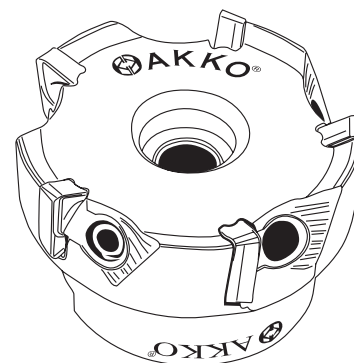
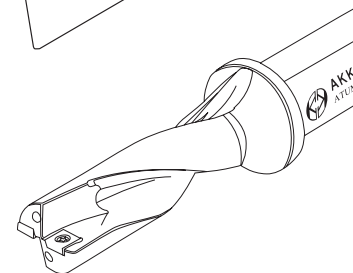
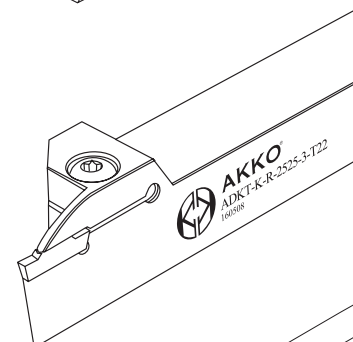
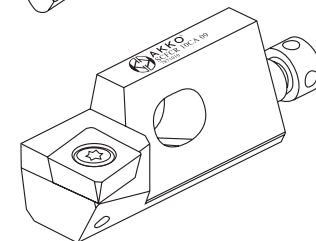
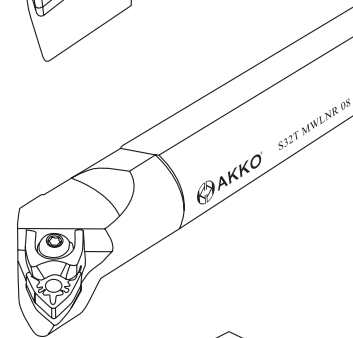
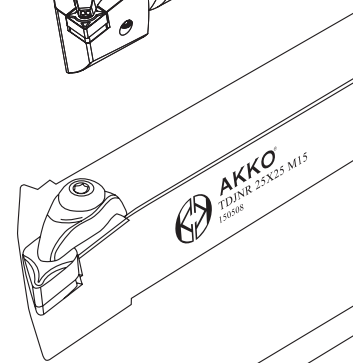
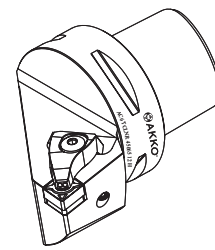

konusulan
the spoken kalite...
quality...

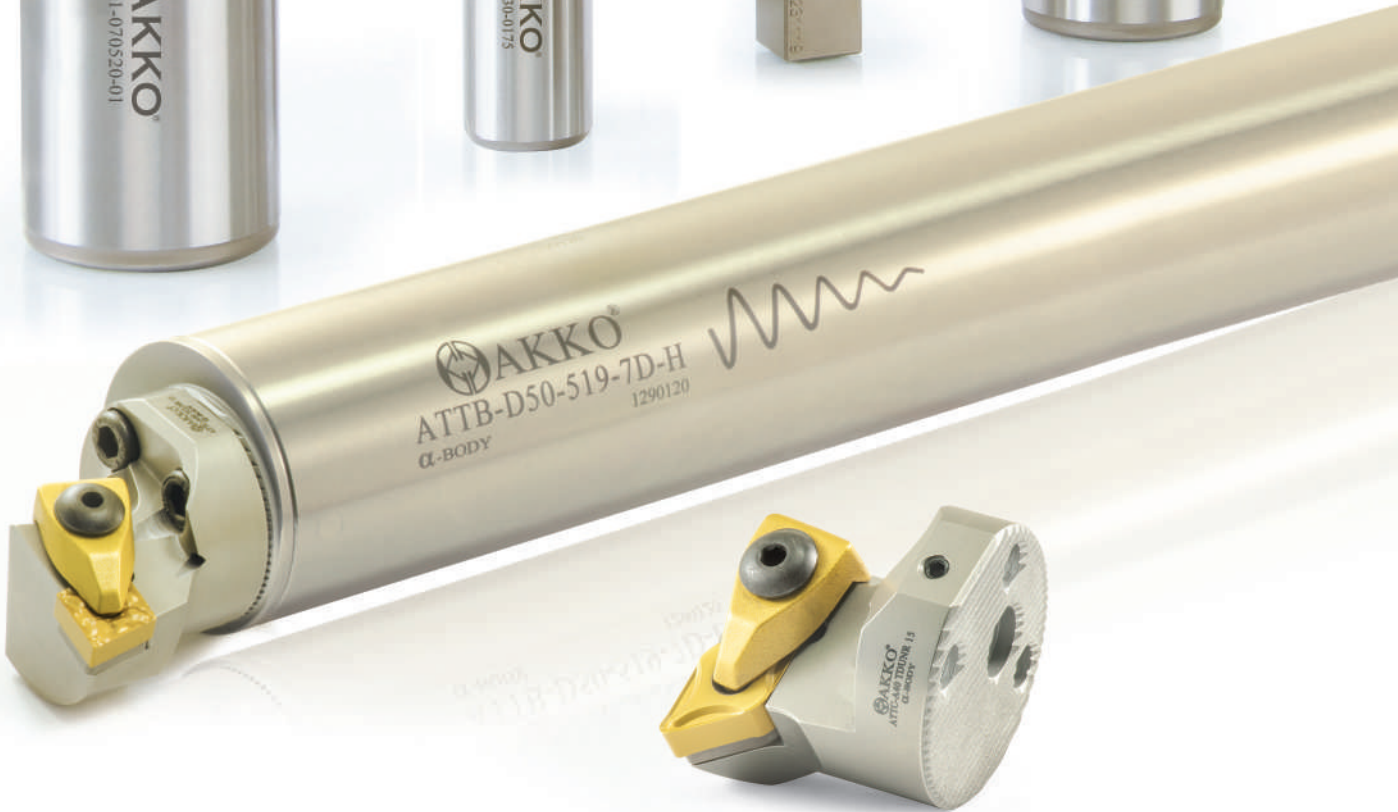

BİLGİLENDİRME
THE INFORMATION
INFORMIEREN

■ Teknik çizim ve fotoğraflar değişiklik gösterebilir.
Illustrations shown may vary from actual product.
Das Produkt kann von dem gezeigten Bild abweichen.

■ H içten su vermeyi ifade eder.
H indicates internal coolant system.
H zeigt inneres Kühlmittel an.

POLİGONAL ŞAFTLI YEKPARE TAKIMLAR
MONOBLOCK TOOLS WITH POLYGONAL SHANK
MONOBLOCKHALTER MIT POLYGONSCHAFT





1	2	3	4	5	6	7	8	9	10	11
A	C6	S	C	L	C	R	17 WF	090 LF	12	H
AKKO	GÖVDE TİPİ SHANK TYPE KÖRPERTYP	SIKMA TİPİ TIGHTENING ANGLE KLEMMSYSTEM	UÇ TİPİ INSERT TYPE WENDESCHNEIDPLATTE	YANAŞMA AÇISI ENTERING ANGLE ANSTELLWINKEL	SERBEST UÇ AÇISI INSERT CLEARANCE ANGLE FREIWINKEL	KESME YÖNÜ CUTTING DIRECTION HALTERAUSFÜHRUNG	FONKSİYONEL GENİŞLİK FUNCTIONAL WIDTH FUNKTIONSBREİTE	TAKIM TAM BOYU FUNCTIONAL LENGTH FUNKTIONSLÄNGE	KESME KENAR UZUNLUĞU CUTTING EDGE LENGTH SCHNEIDKANTENLÄNGE	İÇTEN SU VERME COOLANT MIT INNENKÜHLUNG

POLİGONAL ŞAFTLI YEKPARE TAKIMLAR

MONOBLOCK TOOLS WITH POLYGONAL SHANK
 MONOBLOCKHALTER MIT POLYGONSCHAFT

C4-C5-C6-C8

POLYGON ŞAFTLI DIŞ TORNA TAKIMLARI / EXTERNAL TURNING TOOLS WITH POLYGONSHANK / AUSSEN-DREHHALTER MIT POLYGONSCHAFT
 POLYGON ŞAFTLI DELİK TORNA TAKIMLARI / INTERNAL TURNING TOOLS WITH POLYGONSHANK / INNEN-DREHHALTER MIT POLYGONSCHAFT
 POLYGON ŞAFTLI DIŞ DİŞ AÇMA TAKIMLARI / EXTERNAL THREADING TOOLS WITH POLYGONSHANK / AUSSEN-GEWINDEHALTER MIT POLYGONSCHAFT
 POLYGON ŞAFTLI DELİK İÇİ DİŞ AÇMA TAKIMLARI / INTERNAL THREADING TOOLS WITH POLYGONSHANK / INNEN-GEWINDEHALTER MIT POLYGONSCHAFT

S 3	C 4	L 5	C 6	R 7
---------------	---------------	---------------	---------------	---------------

3 Sıkma Tipi / Method of Mounting of Insert / Klemmsystem				
C	T	M	P	S

4 Uç Tipi / Type of Insert / Plattenform			
C	D	E	K
L	R	S	T
V	W	A	B
H	M	O	P

5 Yanaşma Açısı / Tool Holder Shape Bar Geometry / Anstellwinkel					
A	B	D	E	F	G
J	K	L	M	N	R
S	T	V	Y	Z	

6 Serbest Uç Açısı / Insert Clearance Angle / Freiwinkel / Freiwinkel		
A	B	C
D	E	F
G	N	P

7 Kesme Yönü / Cutting Direction / Halterausführung		
L	N	R

8 WF	9 LF
WF: İşlevsel Genişlik WF: Functional Width WF: Funktionelle Breite	LF: İşlevsel Uzunluk LF: Functional Length LF: Funktionelle Länge



KAPR=95°

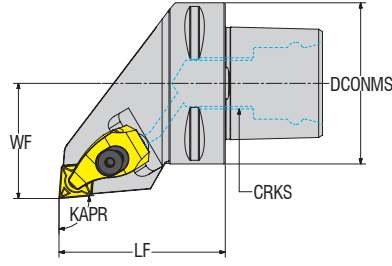

Takım Kodu Ordering Code Bestell-Bezeichnung	Stok Stock Lager		Takım Ölçüleri (mm) Dimension (mm) Abmessung (mm)				Kesici Uç Insert Wendeschneidplatte	Baskı Pabucu Wedge Clamp Spannpratze	Pabuç Vidası Clamp Screw Klemmschraube	Altlık Shim Unterlage	Altlık Vidası Shim Screw Schraube für Unterlage	Yay Spring Feder	Oring Ring Feder	Anahtar Allen Key Innensechskantschlüssel
	R	L	DCONMS	LF	WF	CRKS								
AC4 TCLNR/L 27060 12 H	●	●	40	60	27	M14x1.5	CN.. 120408	ATKH-01-R ATKH-02-L	AKV-33-M6x22	AACN-3-0001	AAV-13-M5x8	AKY-01	AXR-01	AAL-03-3
AC5 TCLNR/L 35060 12 H	●	●	50	60	35	M16x1.5								
AC6 TCLNR/L 45065 12 H	●	●	63	65	45	M20x2								
AC8 TCLNR/L 55080 12 H	●	●	80	80	55	M20x2								



KAPR=93°

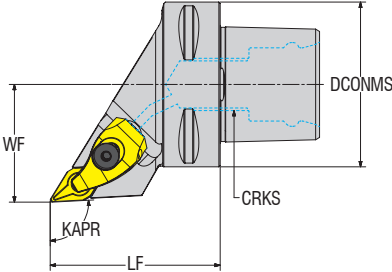

Takım Kodu Ordering Code Bestell-Bezeichnung	Stok Stock Lager		Takım Ölçüleri (mm) Dimension (mm) Abmessung (mm)				Kesici Uç Insert Wendeschneidplatte	Baskı Pabucu Wedge Clamp Spannpratze	Pabuç Vidası Clamp Screw Klemmschraube	Altlık Shim Unterlage	Altlık Vidası Shim Screw Schraube für Unterlage	Yay Spring Feder	Oring Ring Feder	Anahtar Allen Key Innensechskantschlüssel
	R	L	DCONMS	LF	WF	CRKS								
AC4 TDJNR/L 27060 15 H	●	●	40	60	27	M14x1.5	DN.. 150608	ATKH-01-R ATKH-02-L	AKV-33-M6x22	AADN-3-0001	AAV-13-M5x8	AKY-01	AXR-01	AAL-03-3
AC5 TDJNR/L 35060 15 H	●	●	50	60	35	M16x1.5								
AC6 TDJNR/L 45065 15 H	●	●	63	65	45	M20x2								
AC8 TDJNR/L 55080 15 H	●	●	80	80	55	M20x2								

● Stokta / In Stock / Auf Lager ○ Stokta Yok / Non Stock Item / Kein Lagerartikel, Lieferzeit auf Anfrage

Sağ takımlarda sol baskı pabucu, sol takımlarda sağ baskı pabucu kullanılmalıdır.

The left wedge clamp should be used on right-hand tools, and the right wedge clamp should be used on left-hand tools.

Die linke Spannpratze für rechte Werkzeuge und die rechte Spannpratze für linke Werkzeuge verwendet werden.

Sipariş Örneği/Ordering Example/Bestellbeispiel
1 ad./pcs./stück AC4 TCLNR 27060 12 H



KAPR=95°

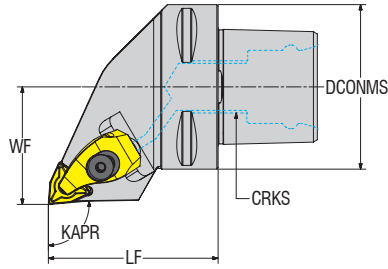

Takım Kodu Ordering Code Bestell-Bezeichnung	Stok Stock Lager		Takım Ölçüleri (mm) Dimension (mm) Abmessung (mm)				Kesici Uç Insert Wendeschneidplatte	Baskı Pabucu Wedge Clamp Spannpratze	Pabuç Vidası Clamp Screw Klemmschraube	Altık Shim Unterlage	Altık Vidası Shim Screw Schraube für Unterlage	Yay Spring Feder	Oring Ring Feder	Anahtar Allen Key Innerschraubenschlüssel
	R	L	DCONMS	LF	WF	CRKS								
AC4 TWLNR/L 27060 08 H	●	●	40	60	27	M14x1.5	WN.. 080408	ATKH-01-R ATKH-02-L	AKV-33-M6x22	AAWN-3-0001	AAV-13-M5x8	AKY-01	AXR-01	AAL-03-3
AC5 TWLNR/L 35060 08 H	●	●	50	60	35	M16x1.5								
AC6 TWLNR/L 45065 08 H	●	●	63	65	45	M20x2								
AC8 TWLNR/L 55080 08 H	●	●	80	80	55	M20x2								



KAPR=95°

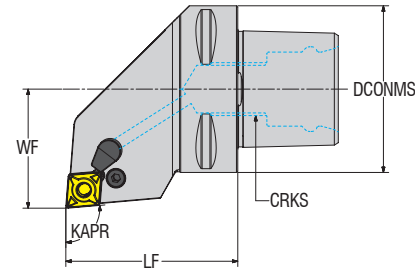

Takım Kodu Ordering Code Bestell-Bezeichnung	Stok Stock Lager		Takım Ölçüleri (mm) Dimension (mm) Abmessung (mm)				Kesici Uç Insert Wendeschneidplatte	Levyey Lever Kniehebel	Levyey Vidası Lever Screw Kniehebelschraube	Altık Shim Unterlage	Altık Yay Shim Spring Feder für Unterlage	Oring Ring Feder	Nozul Nozzle Nozzle Düse	Nozul Vidası Nozzle Screw Düse Schraube	Anahtar Allen Key Innerschraubenschlüssel
	R	L	DCONMS	LF	WF	CRKS									
AC4 PCLNR/L 27050 12 H	●	●	40	50	27	M14x1.5	CN.. 120408	APL-02	ALV-03-M8x19	AACN-3-0001	AAY-02	AXR-01 AOR-01	AN-01	2715-M3x11	AAL-03-3
AC5 PCLNR/L 35060 12 H	●	●	50	60	35	M16x1.5									
AC6 PCLNR/L 45065 12 H	●	●	63	65	45	M20x2									
AC8 PCLNR/L 55080 12 H	●	●	80	80	55	M20x2									

● Stokta / In Stock / Auf Lager ○ Stokta Yok / Non Stock Item / Kein Lagerartikel, Lieferzeit auf Anfrage

Sipariş Örneği/Ordering Example/Bestellbeispiel
1 ad./pcs./stück AC4 TWLNR 27060 08 H

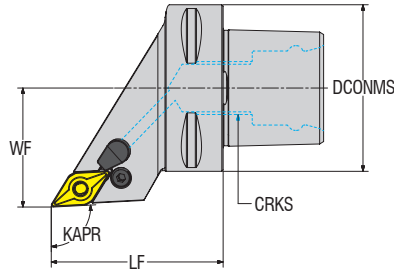

Takım Kodu Ordering Code Bestell-Bezeichnung	Stok Stock Lager		Takım Ölçüleri (mm) Dimension (mm) Abmessung (mm)				Kesici Uç Insert Wendeschneidplatte	Levyeye Lever Kniehebel	Levyeye Vidası Lever Screw Kniehebelschraube	Altılık Shim Unterlage	Altılık Yay Shim Spring Feder für Unterlage	Oring Ring Feder	Nozul Nozzle Nozzle Düse	Nozul Vidası Nozzle Screw Düse Schraube	Anahtar Allen Key Innensechskantschlüssel
	R	L	DCONMS	LF	WF	CRKS									
AC4 PDJNR/L 27060 15 H	●	●	40	60	27	M14x1.5	DN.. 150608	APL-03	ALV-03-M8X19	AADN-3-0001	AAV-02	AXR-01 AOR-01	AN-01	2715-M3x5	AAL-03-3
AC5 PDJNR/L 35060 15 H	●	●	50	60	35	M16x1.5									
AC6 PDJNR/L 45065 15 H	●	●	63	65	45	M20x2									
AC6 PDJNR/L 45165 15 H	●	●	63	165	45	M20x2									
AC8 PDJNR/L 55080 15 H	●	●	80	80	55	M20x2									

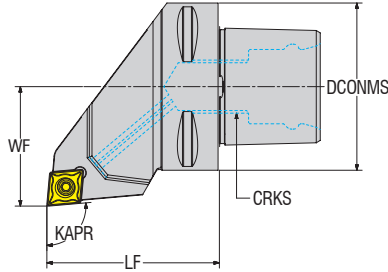

Takım Kodu Ordering Code Bestell-Bezeichnung	Stok Stock Lager		Takım Ölçüleri (mm) Dimension (mm) Abmessung (mm)				Kesici Uç Insert Wendeschneidplatte	Sıkma Vidası Screw Klemmschraube	Altılık Shim Unterlage	Altılık Vidası Shim Screw Schraube für Unterlage	Anahtar Allen Key Innensechskantschlüssel
	R	L	DCONMS	LF	WF	CRKS					
AC4 SCLCR/L 27050 12 H	●	●	40	50	27	M14x1.5	CC.. 120408	1020-M4.5x16	AACN-2-0003	AAV-10-M4.5x8	80-T20
AC5 SCLCR/L 35060 12 H	●	●	50	60	35	M16x1.5					
AC6 SCLCR/L 45065 12 H	●	●	63	65	45	M20x2					

● Stokta / In Stock / Auf Lager ○ Stokta Yok / Non Stock Item / Kein Lagerartikel, Lieferzeit auf Anfrage

Sipariş Örneği/Ordering Example/Bestellbeispiel
1 ad./pcs./stück AC4 PDJNR 27060 15 H



KAPR=93°

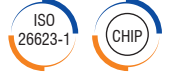
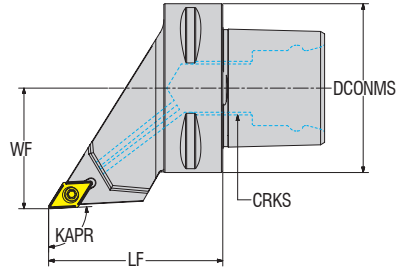

Takım Kodu Ordering Code Bestell-Bezeichnung	Stok Stock Lager		Takım Ölçüleri (mm) Dimension (mm) Abmessung (mm)				Kesici Uç Insert Wendeschneidplatte	Sıkma Vidası Screw Klemmschraube	Altık Shim Unterlage	Altık Vidası Shim Screw Schraube für Unterlage	Tork Anahtar Torx Key Torx-Schlüssel
	R	L	DCONMS	LF	WF	CRKS					
AC4 SDJCR/L 27050 11 H	●	●	40	50	27	M14x1.5	DC.. 11T308	4015-M3.5x11	AADN-2-0001	AAV-08-M3.5X8	80-T15
AC5 SDJCR/L 35060 11 H	●	●	50	60	35	M16x1.5				AAV-06-M3.5X11	
AC6 SDJCR/L 45065 11 H	●	●	63	65	45	M20x2					



KAPR=95°

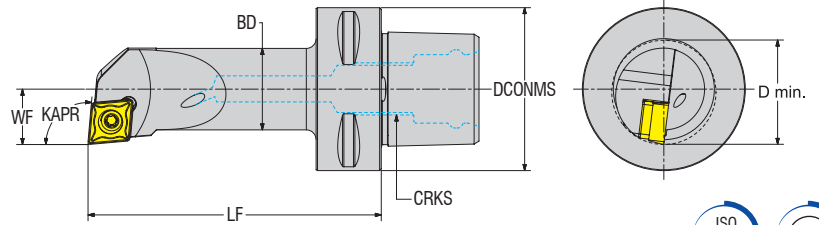

Takım Kodu Ordering Code Bestell-Bezeichnung	Stok Stock Lager		Takım Ölçüleri (mm) Dimension (mm) Abmessung (mm)						Kesici Uç Insert Wendeschneidplatte	Sıkma Vidası Screw Klemmschraube	Altık Shim Unterlage	Altık Vidası Shim Screw Schraube für Unterlage	Tork Anahtar Torx Key Torx-Schlüssel
	R	L	DCONMS	LF	WF	BD	D min.	CRKS					
AC4 SCLCR/L 17090 12 H	●	●	40	90	17	25	32	M14x1.5	CC.. 120408	4020-M4.5x12	AACN-2-0003	AAV-10-M4.5x8	80-T20
AC5 SCLCR/L 17090 12 H	●	●	50	90	17	25	32	M16x1.5					

● Stokta / In Stock / Auf Lager ○ Stokta Yok / Non Stock Item / Kein Lagerartikel, Lieferzeit auf Anfrage

Sipariş Örneği/Ordering Example/Bestellbeispiel
1 ad./pcs./stück AC4 SDJCR 27050 11 H

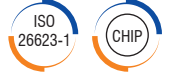
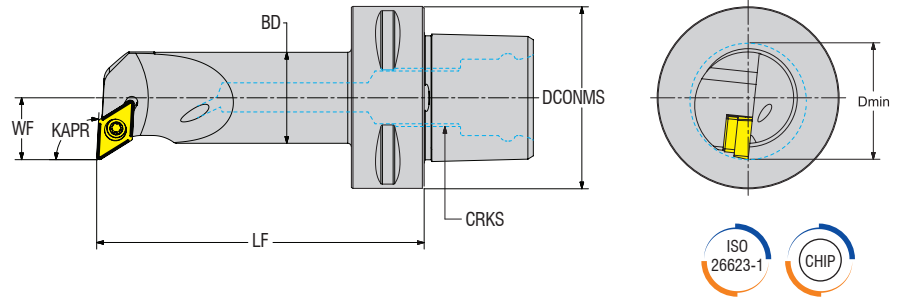

Takım Kodu Ordering Code Bestell-Bezeichnung	Stok Stock Lager		Takım Ölçüleri (mm) Dimension (mm) Abmessung (mm)					Kesici Uç Insert Wendeschneidplatte	Yedek Parçaları / Spare Parts / Ersatzteile				
	R	L	DCONMS	LF	WF	BD	D. min		CRKS	Sıkma Vidası Screw Klemmschraube	Altık Shim Unterlage	Altık Vidası Shim Screw Schraube für Unterlage	Tork Anahtar Torx Key Torx-Schlüssel
AC4 SDUCR/L 13080 11 H	●	●	40	80	13	20	25	M14x1.5	DC.. 11T308	4015-M3.5x11	AADN-2-0001	AAV-08-M3.5x8	80-T15
AC4 SDUCR/L 17090 11 H	●	●	40	90	17	20	25	M14x1.5					
AC5 SDUCR/L 13080 11 H	●	●	50	80	13	25	32	M16x1.5					
AC5 SDUCR/L 17090 11 H	●	●	50	90	17	25	32	M16x1.5					

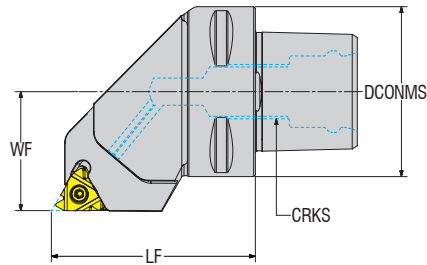

Takım Kodu Ordering Code Bestell-Bezeichnung	Stok Stock Lager		Takım Ölçüleri (mm) Dimension (mm) Abmessung (mm)				Kesici Uç Insert Wendeschneidplatte	Sıkma Vidası Screw Klemmschraube	Yedek Parçaları / Spare Parts / Ersatzteile		Altık Vidası Shim Screw Schraube für Unterlage	Altık Vidası Pulu Shim Screw Ring Schraube für Unterlage	Tork Anahtar Torx Key Torx-Schlüssel
	R	L	DCONMS	LF	WF	CRKS			Sag Altık Right Shim U-Platte für WSP rechts	Sol Altık Left Shim U-Platte für WSP links			
AC4 TER/L 27050 16 H	●	●	40	50	27	M14x1.5	16 ER/EL	1710-U5-40x12.2	ATS-16E	ATS-16I	AAV-11-U5 40x4.5	ABPL-03	82-T10
AC5 TER/L 35060 16 H	●	●	50	60	35	M16x1.5							
AC6 TER/L 45065 16 H	●	●	63	65	45	M20x2							

● Stokta / In Stock / Auf Lager ○ Stokta Yok / Non Stock Item / Kein Lagerartikel, Lieferzeit auf Anfrage

Sipariş Örneği/Ordering Example/Bestellbeispiel
1 ad./pcs./stück AC4 SDUCR 13080 11 H

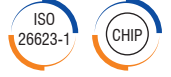
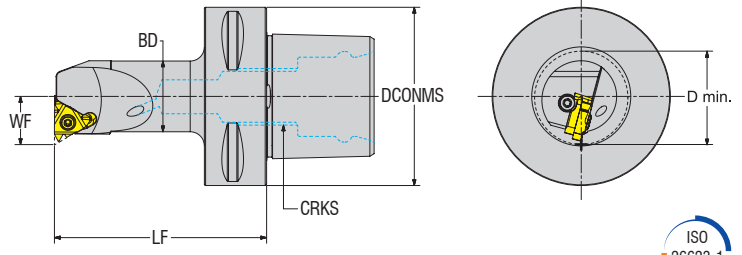

Takım Kodu Ordering Code Bestell-Bezeichnung	Stok Stock Lager		Takım Ölçüleri (mm) Dimension (mm) Abmessung (mm)					Kesici Uç Insert Wendeschneidplatte	Yedek Parçaları / Spare Parts / Ersatzteile						
	R	L	DCONMS	LF	WF	BD	D min.		CRKS	Sıkma Vidası Screw Klemmschraube	Sağ Altlık Right Shim U-Platte für WSP rechts	Sol Altlık Left Shim U-Platte für WSP links	Altlık Vidası Shim Screw Schraube für Unterlage	Altlık Vidası Pulu Shim Screw Ring Schraube für Unterlagerung	Tork Anahtar Torx Key Torx-Schlüssel
	●	●	●	●	●	●	●		●	●	●	●	●	●	●
AC4 TIR/L 14060 16 H	●	●	40	60	14	20	33	M14x1.5	16 IR/L	1710-U5-40x12.2	ATS-16E	ATS-16I	AAV-11-U5-40x4.5	ABPL-03	82-T10
AC4 TIR/L 17070 16 H	●	●	40	70	17	25	33	M14x1.5							
AC4 TIR/L 22090 16 H	●	●	40	90	22	32	40	M14x1.5							
AC5 TIR/L 17070 16 H	●	●	50	70	17	25	33	M16x1.5							
AC5 TIR/L 22090 16 H	●	●	50	90	22	32	33	M16x1.5							
AC5 TIR/L 27105 16 H	●	●	50	105	27	40	40	M16x1.5							
AC6 TIR/L 17075 16 H	●	●	63	75	17	25	33	M20x2							
AC6 TIR/L 22090 16 H	●	●	63	90	22	32	33	M20x2							
AC6 TIR/L 27105 16 H	●	●	63	105	27	40	40	M20x2							

● Stokta / In Stock / Auf Lager ○ Stokta Yok / Non Stock Item / Kein Lagerartikel, Lieferzeit auf Anfrage

Sipariş Örneği/Ordering Example/Bestellbeispiel
 1 ad./pcs./stück AC4 TIR 14060 16 H





DIŞ TORNA TAKIMLARI
EXTERNAL TURNING TOOLHOLDERS
DREHEN - AUßENDREHHALTER





1 Sıkma Tipi / Method of Mounting of Insert / Klemmsystem

P 1	S 2	K 3	N 4	R 5
C	D	E	K	
L	R	S	T	
V	W	A	B	
H	M	O	P	

Deliksiz Üstten Sıkma Top Clamping Without Hole Präzenklammung	Üstten Delikli Sıkma Top and Hole Clamping KeilSpannpratzen-system	Üstten ve Delikten Sıkma Top and Hole Clamping KeilSpannpratzen-system	Delikten Levye ile Sıkma Hole Clamping (Lever Lock) Knehebel-Spann-system	Vida ile Sıkma Screw on Schrauben-Spann-system
C	T	M	P	S

2 Uç Tipi / Type of Insert / Plattenform

C	D	E	K
L	R	S	T
V	W	A	B
H	M	O	P

3 Yanaşma Açısı / Tool Holder Shape Bar Geometry / Anstellwinkel

A	B	D	E	F	G
J	K	L	M	N	R
S	T	V	Y	Z	

4 Serbest Uç Açısı / Insert Clearance Angle / Freiwinkel / Freiwinkel

A	B	C
D	E	F
G	N	P

5 Kesme Yönü / Cutting Direction / Halterausführung

6 Kesme Kenar Yüksekliği / Cutting Edge Height / Schalthöhe

7 Şaft Genişliği / Shank Width / Schaftbreite

8 Şaft Boyu / Shank Length / Schaftlänge

9 Kesme Kenar Uzunluğu / Cutting Edge Length / Schneidkantenlänge

10 Baskı Pabucu / Wedge Clamp / Spannpratze

25 6	25 7	-	M 8	12 9	C 10
----------------	----------------	----------	---------------	----------------	----------------

A -32	H -100	Q -180	x-special
B -40	J -110	R -200	
C -50	K -125	S -250	
D -60	L -140	T -300	
E -70	M -150	U -350	
F -80	N -160	V -400	
G -90	P -170	W -450	

L	N	R

H

B

8 Şaft Boyu / Shank Length / Schaftlänge

A -32	H -100	Q -180	x-special
B -40	J -110	R -200	
C -50	K -125	S -250	
D -60	L -140	T -300	
E -70	M -150	U -350	
F -80	N -160	V -400	
G -90	P -170	W -450	

9 Kesme Kenar Uzunluğu / Cutting Edge Length / Schneidkantenlänge

A.B.K	C.D.E.M.V	H	L		
O	P	R	S	T	W

10 Baskı Pabucu / Wedge Clamp / Spannpratze



*konusulan
the spoken kalite...
quality...*

T-SİSTEM

T-SİSTEM DIŞ TORNA KATERLERİ
T-SYSTEM EXTERNAL TURNING TOOLHOLDERS
T-SYSTEM AUSSEN - DREHHALTER MIT INNENKÜHLUNG



DETAYLI BİLGİ İÇİN BARKODU OKUTUNUZ
SCAN ME FOR MORE DETAILS
FÜR DETAILS BITTE DEN QR CODE SCANNEN

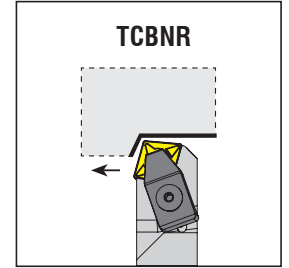
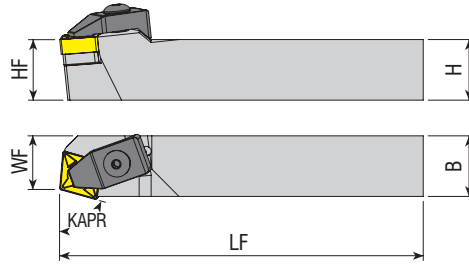
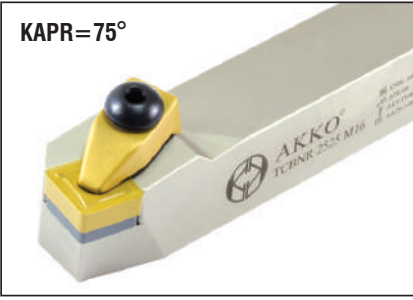

Takım Kodu Ordering Code Bestell-Bezeichnung	Stok Stock Lager		Takım Ölçüleri (mm) Dimension (mm) Abmessung (mm)				Kesici Uç Insert Wendeschneidplatte	Yedek Parçaları / Spare Parts / Ersatzteile						
	R	L	HF=H	B	LF	WF		Baskı Pabucu Wedge Clamp Spannpratze	Pabuç Vidası Clamp Screw Klemmschraube	Altlık Shim Unterlage	Altlık Vidası Shim Screw Schraube für Unterlage	Segman Ring Feder	Pul Stamp Ring	Anahtar Allen Key Innensechskantschlüssel
	●	○												
TCBNR/L 2525 M16	●	○	25	25	150	22	CN.. 1606..	ATK-04	AKV-19-M7x25	AACN-3-0002	AAV-05-M6x15	AS-02	ABPL-02	AAL-05-4

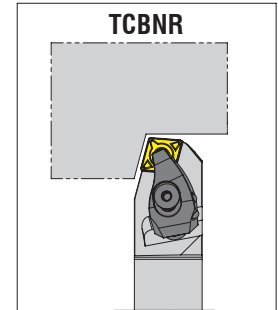
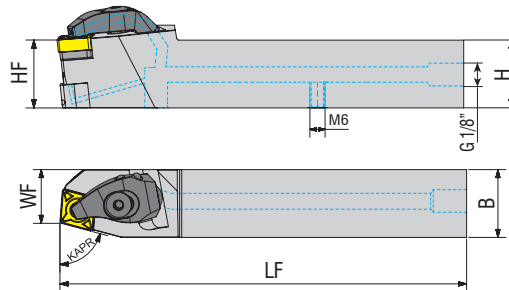

Takım Kodu Ordering Code Bestell-Bezeichnung	Stok Stock Lager		Takım Ölçüleri (mm) Dimension (mm) Abmessung (mm)				Kesici Uç Insert Wendeschneidplatte	Yedek Parçaları / Spare Parts / Ersatzteile							
	R	L	HF=H	B	LF	WF		Baskı Pabucu Wedge Clamp Spannpratze	Pabuç Vidası Clamp Screw Klemmschraube	Altlık Shim Unterlage	Altlık Vidası Shim Screw Schraube für Unterlage	Yay Spring Feder	Oring Ring Feder	Sızdırmaz Vidâ Threaded Pin Gewindestift	Anahtar Allen Key Innensechskantschlüssel
	●	○													
TCBNR/L 2020 K12-H	○	○	20	20	125	16	CN.. 1204..	ATKH-01-R	AKV-33-M6x22	AACN-3-0001	AAV-02-M5x12	AKY-01	AXR-01	2705-G1/8x5.5	AAL-03-3
TCBNR/L 2525 M12-H	○	○	25	25	150	22		ATKH-02-L							
TCBNR/L 3232 P12-H	○	○	32	32	170	29.5									

R: Sağ / Right / Rechts L: Sol / Left / Links

● Stokta / In Stock / Auf Lager ○ Stokta Yok / Non Stock Item / Kein Lagerartikel, Lieferzeit auf Anfrage

VDI tutucu ile uyumludur. / Compatible with VDI holders. / Kompatibel mit VDI Werkzeughalter.

Sipariş Örneği/Ordering Example/Bestellbeispiel

1 ad./pcs./stück TCBNR 2525 M16

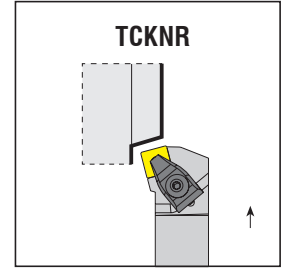
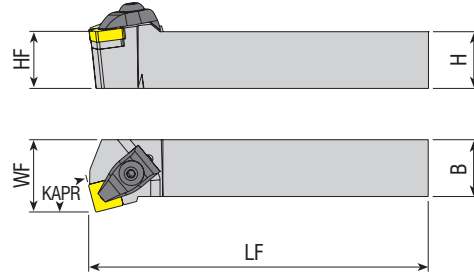

Takım Kodu Ordering Code Bestell-Bezeichnung	Stok Stock Lager		Takım Ölçüleri (mm) Dimension (mm) Abmessung (mm)				Kesici Uç Insert Wendeschneidplatte	Yedek Parçaları / Spare Parts / Ersatzteile							
	R	L	HF=H	B	LF	WF		Baskı Pabucu Wedge Clamp Spannpratze	Pabuç Vidası Clamp Screw Klemmschraube	Altlık Shim Unterlage	Altlık Vidası Shim Screw Schraube für Unterlage	Segman Ring Feder	Pul Stamp Ring	Anahtar Allen Key Innensechskantschlüssel	
TCKNR/L 2020 K12	●	●	20	20	125	25	CN.. 1204..	ATK-02	AKV-30-M6x22	AACN-3-0001	AAV-02-M5x12	AS-01	ABPL-01	AAL-03-3	
TCKNR/L 2525 M12	●	●	25	25	150	32									
TCKNR/L 3232 P12	●	●	32	32	170	40									
TCKNR/L 2525 M16	●	●	25	25	150	32	CN.. 1606..	ATK-04	AKV-19-M7x25	AACN-3-0002	AAV-05-M6x15	AS-02	ABPL-02	AAL-05-4	
TCKNR/L 3232 P16	●	●	32	32	170	40									

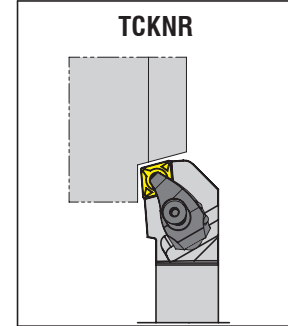
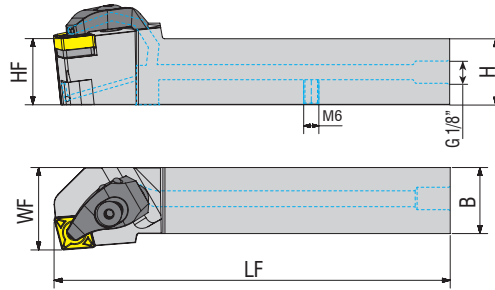

Takım Kodu Ordering Code Bestell-Bezeichnung	Stok Stock Lager		Takım Ölçüleri (mm) Dimension (mm) Abmessung (mm)				Kesici Uç Insert Wendeschneidplatte	Yedek Parçaları / Spare Parts / Ersatzteile							
	R	L	HF=H	B	LF	WF		Baskı Pabucu Wedge Clamp Spannpratze	Pabuç Vidası Clamp Screw Klemmschraube	Altlık Shim Unterlage	Altlık Vidası Shim Screw Schraube für Unterlage	Yay Spring Feder	Oring Ring Feder	Sızdırmaz Vida Threaded Pin Gewindestift	Anahtar Allen Key Innensechskantschlüssel
TCKNR/L 2020 K12-H	○	○	20	20	125	25	CN.. 1204..	ATKH-01-R ATKH-02-L	AKV-33-M6x22	AACN-3-0001	AAV-13-M5x8	AKY-01	AXR-01	2705-G1/8x5.5	AAL-03-3
TCKNR/L 2525 M12-H	○	○	25	25	150	32									
TCKNR/L 3232 P12-H	○	○	32	32	170	40									

R: Sağ / Right / Rechts L: Sol / Left / Links

● Stokta / In Stock / Auf Lager ○ Stokta Yok / Non Stock Item / Kein Lagerartikel, Lieferzeit auf Anfrage

VDI tutucu ile uyumludur. / Compatible with VDI holders. / Kompatibel mit VDI Werkzeughalter.

Sipariş Örneği/Ordering Example/Bestellbeispiel

1 ad./pcs./stück TCKNR 2020 K12

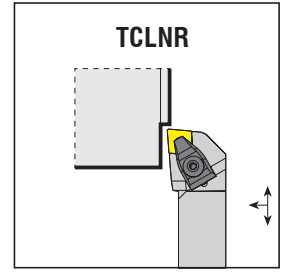
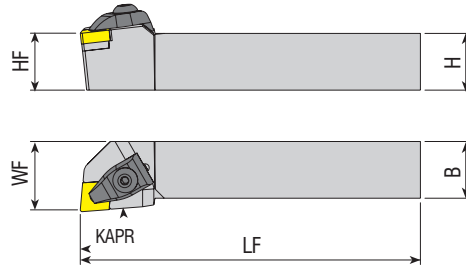

Takım Kodu Ordering Code Bestell-Bezeichnung	Stok Stock Lager		Takım Ölçüleri (mm) Dimension (mm) Abmessung (mm)				Kesici Uç Insert Wendeschneidplatte	Yedek Parçaları / Spare Parts / Ersatzteile								
	R	L	HF=H	B	LF	WF		Baskı Pabuçu Wedge Clamp Spannpratze	Pabuç Vidası Clamp Screw Klemmschraube	Altlık Shim Unterlage	Altlık Vidası Shim Screw Schraube für Unterlage	Segman Ring Feder	Pul Stamp Ring	Anahtar Allen Key Innensechskantschlüssel		
TCLNR/L 2020 K12	●	●	20	20	125	25	CN.. 1204..									
TCLNR/L 2525 M12	●	●	25	25	150	32										
TCLNR/L 3232 P12	●	●	32	32	170	40										
TCLNR/L 4040 S12	●	●	40	40	250	50										
TCLNR/L 5050 S12	●	●	50	50	250	63										
TCLNR/L 2525 M16	●	●	25	25	150	32	CN.. 1606..									
TCLNR/L 3232 P16	●	●	32	32	170	40										

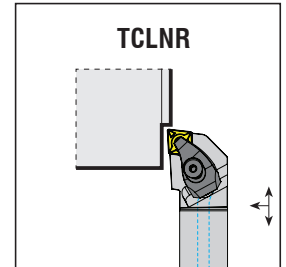
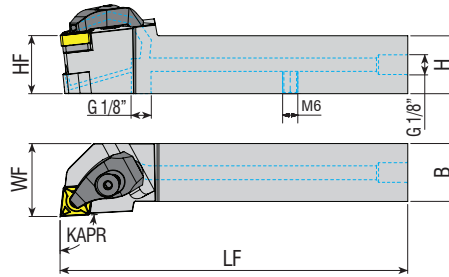

Takım Kodu Ordering Code Bestell-Bezeichnung	Stok Stock Lager		Takım Ölçüleri (mm) Dimension (mm) Abmessung (mm)				Kesici Uç Insert Wendeschneidplatte	Yedek Parçaları / Spare Parts / Ersatzteile								
	R	L	HF=H	B	LF	WF		Baskı Pabuçu Wedge Clamp Spannpratze	Pabuç Vidası Clamp Screw Klemmschraube	Altlık Shim Unterlage	Altlık Vidası Shim Screw Schraube für Unterlage	Yay Spring Feder	Oring Ring Feder	Sızdırmaz Vida Threaded Pin Gewindestift	Anahtar Allen Key Innensechskantschlüssel	
TCLNR/L 2020 K12-H	●	●	20	20	125	25	CN.. 1204..									
TCLNR/L 2525 M12-H	●	●	25	25	150	32										
TCLNR/L 3232 P12-H	●	●	32	32	170	40										
new TCLNR/L 2525 M16-H	●	○	25	25	150	32	CN.. 1606..									

R: Sağ / Right / Rechts L: Sol / Left / Links

● Stokta / In Stock / Auf Lager ○ Stokta Yok / Non Stock Item / Kein Lagerartikel, Lieferzeit auf Anfrage

VDI tutucu ile uyumludur. / Compatible with VDI holders. / Kompatibel mit VDI Werkzeughalter.

Sipariş Örneği/Ordering Example/Bestellbeispiel

1 ad./pcs./stück TCLNR 2020 K12

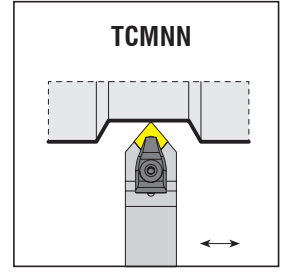
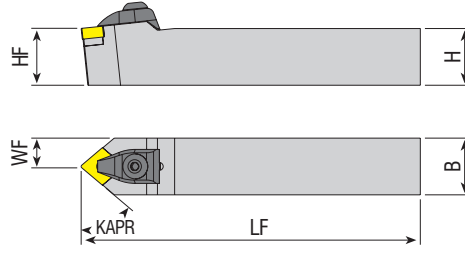
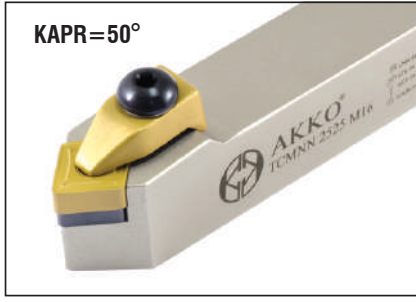

Takım Kodu Ordering Code Bestell-Bezeichnung	Stok Stock Lager	Takım Ölçüleri (mm) Dimension (mm) Abmessung (mm)				Kesici Uç Insert Wendeschneidplatte	Yedek Parçaları / Spare Parts / Ersatzteile								
		HF=H	B	LF	WF		Baskı Pabucu Wedge Clamp Spannpratze	Pabuç Vidası Clamp Screw Klemmschraube	Altlık Shim Unterlage	Altlık Vidası Shim Screw Schraube für Unterlage	Segman Ring Feder	Pul Stamp Ring	Anahtar Allen Key Innensechskantschlüssel		
TCMNN 1616 H12	●	16	16	100	8	CN.. 1204..									
TCMNN 2020 K12	●	20	20	125	10										
TCMNN 2525 M12	●	25	25	150	12.5										
TCMNN 3232 P12	●	32	32	170	16										
TCMNN 2525 M16	●	25	25	150	12.5	CN.. 1606..									
TCMNN 3232 P16	●	32	32	170	16										
TCMNN 4040 S16	○	40	40	250	20										

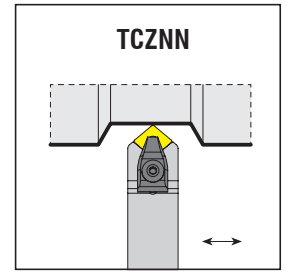
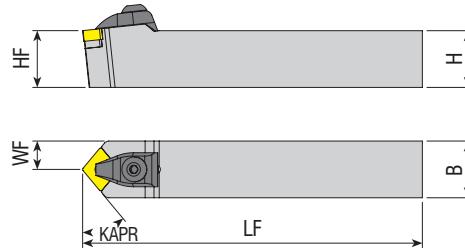

Takım Kodu Ordering Code Bestell-Bezeichnung	Stok Stock Lager	Takım Ölçüleri (mm) Dimension (mm) Abmessung (mm)				Kesici Uç Insert Wendeschneidplatte	Yedek Parçaları / Spare Parts / Ersatzteile								
		HF=H	B	LF	WF		Baskı Pabucu Wedge Clamp Spannpratze	Pabuç Vidası Clamp Screw Klemmschraube	Altlık Shim Unterlage	Altlık Vidası Shim Screw Schraube für Unterlage	Segman Ring Feder	Pul Stamp Ring	Anahtar Allen Key Innensechskantschlüssel		
TCZNN 2020 K12	●	20	20	125	10	CN.. 1204..									
TCZNN 2525 M12	●	25	25	150	12.5										
TCZNN 3232 P12	●	32	32	170	16										
TCZNN 2525 M16	●	25	25	150	12.5	CN.. 1606..									
TCZNN 3232 P16	●	32	32	170	16										

R: Sağ / Right / Rechts L: Sol / Left / Links

● Stokta / In Stock / Auf Lager ○ Stokta Yok / Non Stock Item / Kein Lagerartikel, Lieferzeit auf Anfrage

Sipariş Örneği/Ordering Example/Bestellbeispiel

1 ad./pcs./stück TCMNN 1616 H12

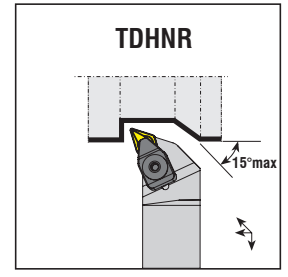
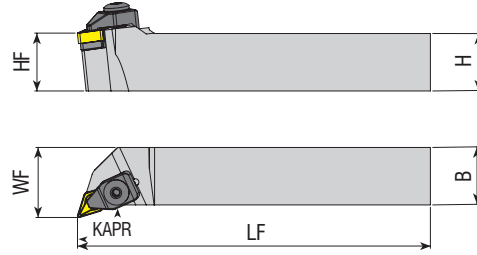

Takım Kodu Ordering Code Bestell-Bezeichnung	Stok Stock Lager		Takım Ölçüleri (mm) Dimension (mm) Abmessung (mm)				Kesici Uç Insert Wendeschneidplatte	Yedek Parçaları / Spare Parts / Ersatzteile						
	R	L	HF=H	B	LF	WF		Baskı Pabuçu Wedge Clamp Spannpratze	Pabuç Vidası Clamp Screw Klemmschraube	Altlık Shim Unterlage	Altlık Vidası Shim Screw Schraube für Unterlage	Segman Ring Feder	Pul Stamp Ring	Anahtar Allen Key Innensechskantschlüssel
TDHNR/L 2525 M11	●	●	25	25	150	31	DN.. 1104..	ATK-01	AKV-01-M5x22	AADN-2-0001	AAV-04-M5x12	-		
TDHNR/L 2020 K15	●	●	20	20	125	25								
TDHNR/L 2525 M15	●	●	25	25	150	32	DN.. 1506..	ATK-02	AKV-30-M6x22	AADN-3-0001	AAV-02-M5x12	AS-01	ABPL-01	AAL-03-3
TDHNR/L 3232 P15	●	●	32	32	170	40								

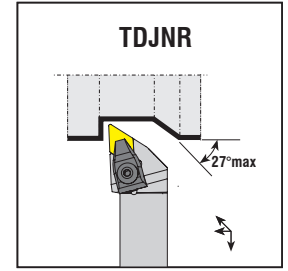
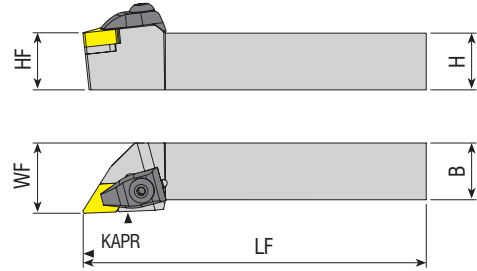
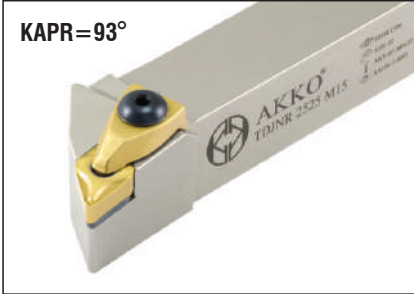

Takım Kodu Ordering Code Bestell-Bezeichnung	Stok Stock Lager		Takım Ölçüleri (mm) Dimension (mm) Abmessung (mm)				Kesici Uç Insert Wendeschneidplatte	Yedek Parçaları / Spare Parts / Ersatzteile						
	R	L	HF=H	B	LF	WF		Baskı Pabuçu Wedge Clamp Spannpratze	Pabuç Vidası Clamp Screw Klemmschraube	Altlık Shim Unterlage	Altlık Vidası Shim Screw Schraube für Unterlage	Segman Ring Feder	Pul Stamp Ring	Anahtar Allen Key Innensechskantschlüssel
TDJNR/L 1616 H11	●	●	16	16	100	20								
TDJNR/L 2020 K11	●	●	20	20	125	25	DN.. 1104..	ATK-01	AKV-01-M5x22	AADN-2-0001	AAV-04-M5x12	-		
TDJNR/L 2525 M11	●	●	25	25	150	32								
TDJNR/L 2020 K15	●	●	20	20	125	25								
TDJNR/L 2525 M15	●	●	25	25	150	32								
TDJNR/L 3232 P15	●	●	32	32	170	40	DN.. 1506..	ATK-02	AKV-30-M6x22	AADN-3-0001	AAV-02-M5x12	AS-01	ABPL-01	AAL-03-3
TDJNR/L 4040 S15	●	●	40	40	250	50								
TDJNR/L 5050 S15	○	○	50	50	250	63								
TDJNR/L 2020 K1504	●	●	20	20	125	25								
TDJNR/L 2525 M1504	●	●	25	25	150	32	DN.. 1504..	ATK-02	AKV-30-M6x22	AADN-2-0003	AAV-02-M5x12	AS-01		
TDJNR/L 3232 P1504	●	●	32	32	170	40								
TDJNR/L 4040 S1504	●	●	40	40	250	50								

R: Sağ / Right / Rechts L: Sol / Left / Links
● Stokta / In Stock / Auf Lager ○ Stokta Yok / Non Stock Item / Kein Lagerartikel, Lieferzeit auf Anfrage

Sipariş Örneği/Ordering Example/Bestellbeispiel
1 ad./pcs./stück TDHNR 2525 M11



KAPR=93°

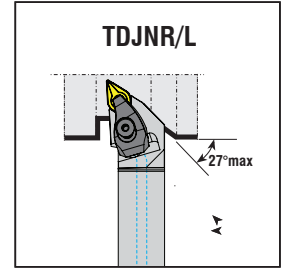
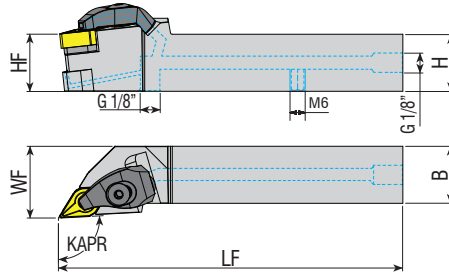

Takım Kodu
Ordering Code
Bestell-Bezeichnung

Stok
Stock
Lager

Takım Ölçüleri (mm)
Dimension (mm)
Abmessung (mm)

Kesici Uç
Insert
Wendeschneidplatte

Baskı Pabucu
Wedge Clamp
Spannpratze

Pabuç Vidası
Clamp Screw
Klemmschraube

Altlık
Shim
Unterlage

Altlık Vidası
Shim Screw
Schraube für Unterlage

Yay
Spring
Feder

Oring
Ring
Feder

Sızdırmaz Vida
Threaded Pin
Gewindestift

Anahtar
Allen Key
Innenschlankschlüssel

Yedek Parçaları / Spare Parts / Ersatzteile

Takım Kodu Ordering Code Bestell-Bezeichnung	Stok Stock Lager		Takım Ölçüleri (mm) Dimension (mm) Abmessung (mm)				Kesici Uç Insert Wendeschneidplatte	Baskı Pabucu Wedge Clamp Spannpratze	Pabuç Vidası Clamp Screw Klemmschraube	Altlık Shim Unterlage	Altlık Vidası Shim Screw Schraube für Unterlage	Yay Spring Feder	Oring Ring Feder	Sızdırmaz Vida Threaded Pin Gewindestift	Anahtar Allen Key Innenschlankschlüssel
	R	L	HF=H	B	LF	WF									
TDJNR/L 2020 K15-H	●	●	20	20	125	25	DN.. 1506..	ATKH-01-R ATKH-02-L	AKV-33-M6x22	AADN-3-0001	AAV-13-M5x8	AKY-01	AXR-01	2705-G1/8x5.5	AAL-03-3
TDJNR/L 2525 M15-H	●	●	25	25	150	32									
TDJNR/L 3232 P15-H	●	●	32	32	170	40									

VDI tutucu ile uyumludur. / Compatible with VDI holders. / Kompatibel mit VDI Werkzeughalter.

KAPR=62.5°

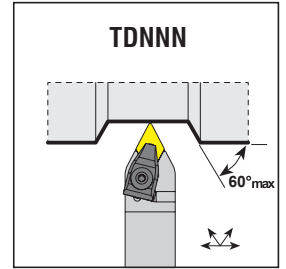
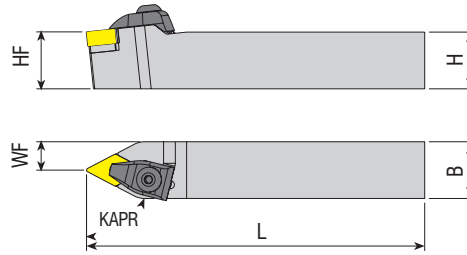

Takım Kodu
Ordering Code
Bestell-Bezeichnung

Stok
Stock
Lager

Takım Ölçüleri (mm)
Dimension (mm)
Abmessung (mm)

Kesici Uç
Insert
Wendeschneidplatte

Baskı Pabucu
Wedge Clamp
Spannpratze

Pabuç Vidası
Clamp Screw
Klemmschraube

Altlık
Shim
Unterlage

Altlık Vidası
Shim Screw
Schraube für Unterlage

Segman
Ring
Feder

Pul Stamp
Stamp
Ring

Anahtar
Allen Key
Innenschlankschlüssel

Yedek Parçaları / Spare Parts / Ersatzteile

Takım Kodu Ordering Code Bestell-Bezeichnung	Stok Stock Lager	Takım Ölçüleri (mm) Dimension (mm) Abmessung (mm)				Kesici Uç Insert Wendeschneidplatte	Baskı Pabucu Wedge Clamp Spannpratze	Pabuç Vidası Clamp Screw Klemmschraube	Altlık Shim Unterlage	Altlık Vidası Shim Screw Schraube für Unterlage	Segman Ring Feder	Pul Stamp Stamp Ring	Anahtar Allen Key Innenschlankschlüssel
		HF=H	B	LF	WF								
TDNNN 1616 H11	●	16	16	100	8	DN.. 1104..	ATK-01	AKV-01-M5x22	AADN-2-0001	AAV-04-M5x12	-	ABPL-01	AAL-03-3
TDNNN 2020 K11	●	20	20	125	10								
TDNNN 2525 M11	●	25	25	150	12.5								
TDNNN 2020 K15	●	20	20	125	10	DN.. 1506..	ATK-02	AKV-30-M6x22	AADN-3-0001	AAV-02-M5x12	AS-01	ABPL-01	AAL-03-3
TDNNN 2525 M15	●	25	25	150	12.5								
TDNNN 3232 P15	●	32	32	170	16								
TDNNN 4040 S15	○	40	40	250	20								
TDNNN 5050 S15	○	50	50	250	25								

R: Sağ / Right / Rechts L: Sol / Left / Links

● Stokta / In Stock / Auf Lager ○ Stokta Yok / Non Stock Item / Kein Lagerartikel, Lieferzeit auf Anfrage

Sipariş Örneği/Ordering Example/Bestellbeispiel

1 ad./pcs./stück TDJNR 2020 K15-H

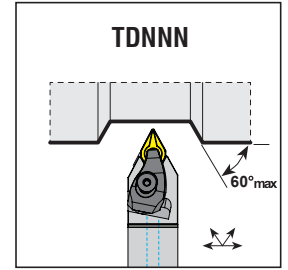
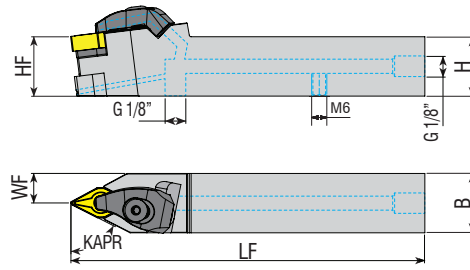

Takım Kodu Ordering Code Bestell-Bezeichnung	Stok Stock Lager	Takım Ölçüleri (mm) Dimension (mm) Abmessung (mm)				Kesici Uç Insert Wendeschneidplatte	Yedek Parçaları / Spare Parts / Ersatzteile								
		HF=H	B	LF	WF		Baskı Pabucu Wedge Clamp Spannpratze	Pabuç Vidası Clamp Screw Klemmschraube	Altlık Shim Unterlage	Altlık Vidası Shim Screw Schraube für Unterlage	Yay Spring Feder	Oring Ring Feder	Sızdırmaz Vida Threaded Pin Gewindestift	Anahtar Allen Key Innensechskantschlüssel	
TDNNN 2525 M15-H	●	25	25	150	32										

VDI tutucu ile uyumludur. / Compatible with VDI holders. / Kompatibel mit VDI Werkzeughalter.

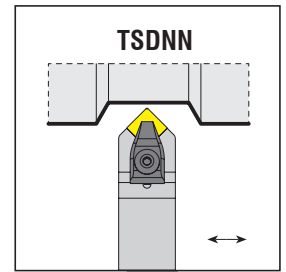
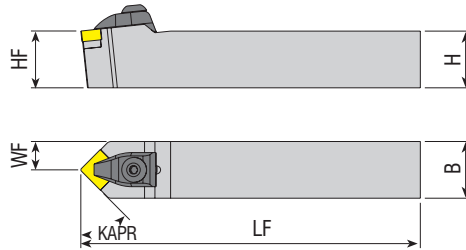

Takım Kodu Ordering Code Bestell-Bezeichnung	Stok Stock Lager	Takım Ölçüleri (mm) Dimension (mm) Abmessung (mm)				Kesici Uç Insert Wendeschneidplatte	Yedek Parçaları / Spare Parts / Ersatzteile								
		HF=H	B	LF	WF		Baskı Pabucu Wedge Clamp Spannpratze	Pabuç Vidası Clamp Screw Klemmschraube	Altlık Shim Unterlage	Altlık Vidası Shim Screw Schraube für Unterlage	Segman Ring Feder	Pul Stamp Ring	Anahtar Allen Key Innensechskantschlüssel		
TSDNN 1616 H12	●	16	16	100	8										
TSDNN 2020 K12	●	20	20	125	10										
TSDNN 2525 M12	●	25	25	150	12.5										
TSDNN 3232 P12	●	32	32	170	16										
TSDNN 2525 M15	○	25	25	150	12.5										
TSDNN 3232 P15	●	32	32	170	16										
TSDNN 4040 S15	○	40	40	250	20										

R: Sağ / Right / Rechts L: Sol / Left / Links

● Stokta / In Stock / Auf Lager ○ Stokta Yok / Non Stock Item / Kein Lagerartikel, Lieferzeit auf Anfrage

Sipariş Örneği/Ordering Example/Bestellbeispiel

1 ad./pcs./stück TDNNN 2525 M15-H

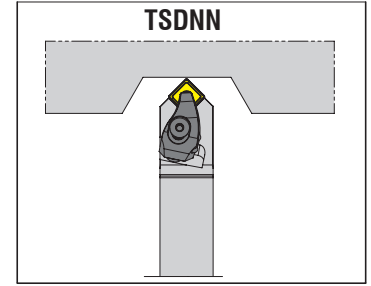
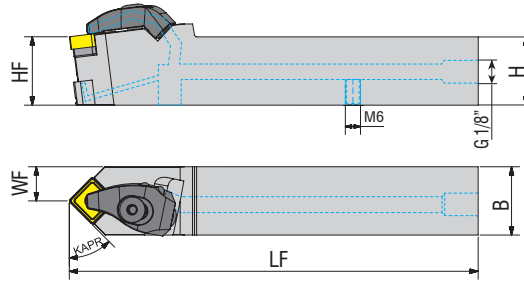
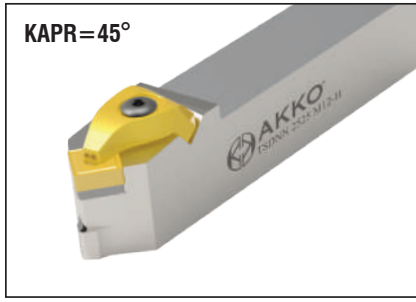

Takım Kodu Ordering Code Bestell-Bezeichnung	Stok Stock Lager	Takım Ölçüleri (mm) Dimension (mm) Abmessung (mm)				Kesici Uç Insert Wendeschneidplatte	Yedek Parçaları / Spare Parts / Ersatzteile									
		HF=H	B	LF	WF		Baskı Pabuçu Wedge Clamp Spannpratze	Pabuç Vidası Clamp Screw Klemmschraube	Altlık Shim Unterlage	Altlık Vidası Shim Screw Schraube für Unterlage	Yay Spring Feder	Oring Ring Feder	Sızdırmaz Vida Threaded Pin Gewindestift	Anahtar Allen Key Innenschlitzschlüssel		
TSDNN 2525 M12-H	○	25	25	150	25	SN.. 1204..	ATKH-01-R	AKV-33-M6x22	AASN-3-0004	AAV-02-M5x12			2705-G1/8x5.5	AAL-03-3		
TSDNN 3232 P12-H	○	32	32	170	16		ATKH-02-L									
TSDNN 2525 M15-H	○	25	25	150	12.7	SN.. 1506..	ATKH-07-R	AKV-39-M7x21	AASN-3-0023	AAV-05-M6x10	AKY-01	AXR-01	2705-G1/8x5.5	AAL-05-4		
TSDNN 3232 P15-H	○	32	32	170	16		ATKH-08-L									
TSDNN 4040 S15-H	○	40	40	250	20											

VDI tutucu ile uyumludur. / Compatible with VDI holders. / Kompatibel mit VDI Werkzeughalter.

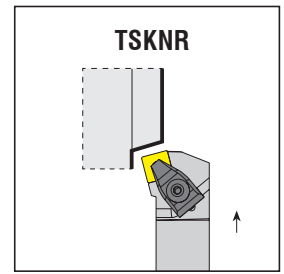
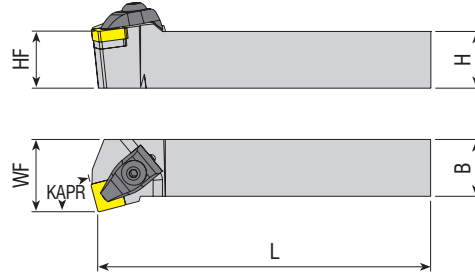

Takım Kodu Ordering Code Bestell-Bezeichnung	Stok Stock Lager		Takım Ölçüleri (mm) Dimension (mm) Abmessung (mm)				Kesici Uç Insert Wendeschneidplatte	Yedek Parçaları / Spare Parts / Ersatzteile									
	R	L	HF=H	B	LF	WF		Baskı Pabuçu Wedge Clamp Spannpratze	Pabuç Vidası Clamp Screw Klemmschraube	Altlık Shim Unterlage	Altlık Vidası Shim Screw Schraube für Unterlage	Segman Ring Feder	Pul Stamp Ring	Anahtar Allen Key Innenschlitzschlüssel			
TSKNR/L 2020 K12	●	●	20	20	125	25	SN.. 1204..	ATK-02	AKV-30-M6x22	AASN-3-0004	AAV-02-M5x12	AS-01	ABPL-01	AAL-03-3			
TSKNR/L 2525 M12	●	●	25	25	150	32		ATK-04	AKV-19-M7x25	AASN-3-0023	AAV-05-M6x15	AS-02	ABPL-02	AAL-05-4			
TSKNR/L 3232 P12	●	●	32	32	170	40											
TSKNR/L 3232 P15	●	●	32	32	170	40											

R: Sağ / Right / Rechts L: Sol / Left / Links

● Stokta / In Stock / Auf Lager ○ Stokta Yok / Non Stock Item / Kein Lagerartikel, Lieferzeit auf Anfrage

Sipariş Örneği/Ordering Example/Bestellbeispiel

1 ad./pcs./stück TSDNN 2525 M12-H

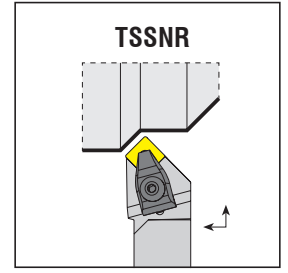
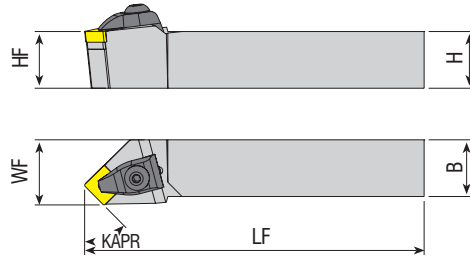

Takım Kodu Ordering Code Bestell-Bezeichnung	Stok Stock Lager		Takım Ölçüleri (mm) Dimension (mm) Abmessung (mm)				Kesici Uç Insert Wendeschneidplatte	Yedek Parçaları / Spare Parts / Ersatzteile							
	R	L	HF=H	B	LF	WF		Baskı Pabucu Wedge Clamp Spannpratze	Pabuç Vidası Clamp Screw Klemmschraube	Altlık Shim Unterlage	Altlık Vidası Shim Screw Schraube für Unterlage	Segman Ring Feder	Pul Stamp Ring	Anahtar Allen Key Innenschlankschlüssel	
TSSNR/L 2020 K12	●	●	20	20	125	25	SN.. 1204..	ATK-02	AKV-30-M6x22	AASN-3-0004	AAV-02-M5x12	AS-01	ABPL-01	AAL-03-3	
TSSNR/L 2525 M12	●	●	25	25	150	32									
TSSNR/L 3232 P12	●	●	32	32	170	40									
TSSNR/L 2525 M15	●	●	25	25	150	32	SN.. 1506..	ATK-04	AKV-19-M7x25	AASN-3-0023	AAV-05-M6x15	AS-02	ABPL-02	AAL-05-4	
TSSNR/L 3232 P15	●	●	32	32	170	40									

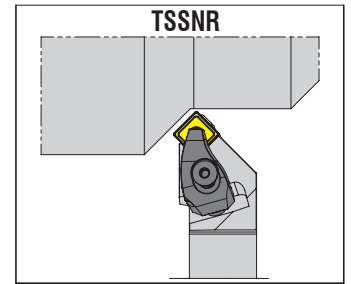
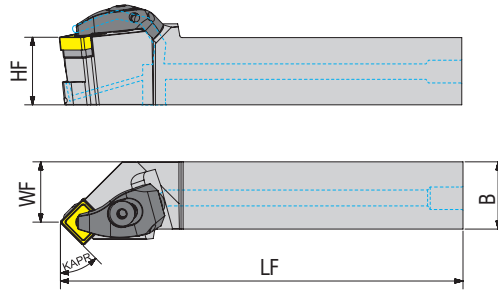

Takım Kodu Ordering Code Bestell-Bezeichnung	Stok Stock Lager		Takım Ölçüleri (mm) Dimension (mm) Abmessung (mm)				Kesici Uç Insert Wendeschneidplatte	Yedek Parçaları / Spare Parts / Ersatzteile							
	R	L	HF=H	B	LF	WF		Baskı Pabucu Wedge Clamp Spannpratze	Pabuç Vidası Clamp Screw Klemmschraube	Altlık Shim Unterlage	Altlık Vidası Shim Screw Schraube für Unterlage	Yay Spring Feder	Oring Ring Feder	Sızdırmaz Vida Threaded Pin Gewindestift	Anahtar Allen Key Innenschlankschlüssel
TSSNR/L 2525 M12-H	○	○	25	25	150	32	SN.. 1204..	ATKH-01-R ATKH-02-L	AKV-33-M6x22	AASN-3-0004	AAV-02-M5x12				AAL-03-3
TSSNR/L 3232 P12-H	○	○	32	32	170	32									
TSSNR/L 2525 M15-H	○	○	25	25	150	40									
TSSNR/L 3232 P15-H	○	○	32	32	170	40	SN.. 1506..	ATKH-07-R ATKH-08-L	AKV-39-M7x21	AASN-3-0023	AAV-05-M6x10	AKY-01	AXR-01	2705-G1/8x5.5	AAL-05-4
TSSNR/L 4040 S15-H	○	○	40	40	250	50									

R: Sağ / Right / Rechts L: Sol / Left / Links

● Stokta / In Stock / Auf Lager ○ Stokta Yok / Non Stock Item / Kein Lagerartikel, Lieferzeit auf Anfrage

VDI tutucu ile uyumludur. / Compatible with VDI holders. / Kompatibel mit VDI Werkzeughalter.

Sağ takımlarda sol baskı pabucu, sol takımlarda sağ baskı pabucu kullanılmalıdır.

The left wedge clamp should be used on right-hand tools, and the right wedge clamp should be used on left-hand tools.

Die linke Spannpratze für rechte Werkzeuge und die rechte Spannpratze für linke Werkzeuge verwendet werden.

Sipariş Örneği/Ordering Example/Bestellbeispiel

1 ad./pcs./stück TSSNR 2020 K12

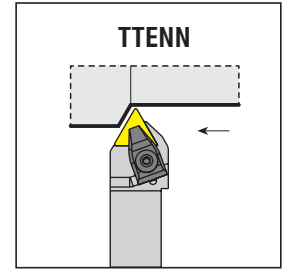
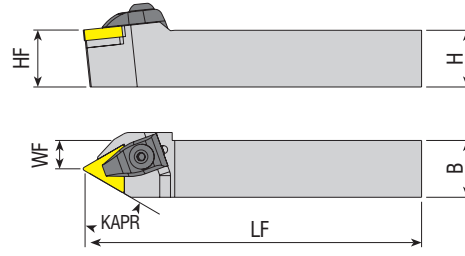

Takım Kodu Ordering Code Bestell-Bezeichnung	Stok Stock Lager		Takım Ölçüleri (mm) Dimension (mm) Abmessung (mm)				Kesici Uç Insert Wendeschneidplatte	Yedek Parçaları / Spare Parts / Ersatzteile						
	R	L	HF=H	B	LF	WF		Baskı Pabucu Wedge Clamp Spannpratze	Pabuç Vidası Clamp Screw Klemmschraube	Altlık Shim Unterlage	Altlık Vidası Shim Screw Schraube für Unterlage	Segman Ring Feder	Pul Stamp Ring	Anahtar Allen Key Innenschlankschlüssel
TTENN 2020 K16	●		20	20	125	10	TN.. 1604..					-	ABPL-01	AAL-03-3
TTENN 2525 M16	●		25	25	150	12.5								
TTENN 3232 P16	●		32	32	170	16								
TTENN 2525 M22	●		25	25	150	12.5	TN.. 2204...					AS-01	ABPL-01	AAL-03-3
TTENN 3232 P22	●		32	32	170	16								
TTENN 4040 S22	○		40	40	250	20								

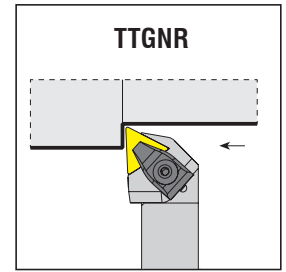
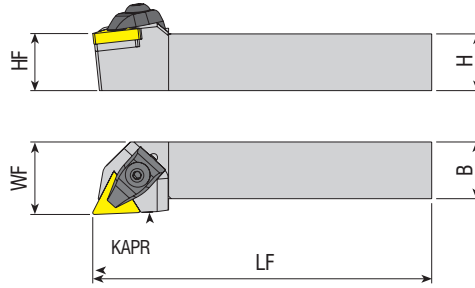
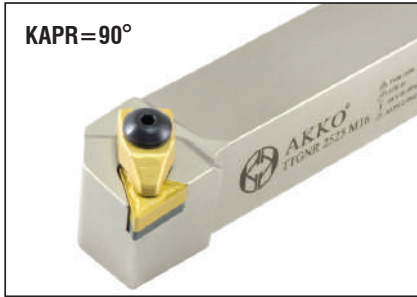

Takım Kodu Ordering Code Bestell-Bezeichnung	Stok Stock Lager		Takım Ölçüleri (mm) Dimension (mm) Abmessung (mm)				Kesici Uç Insert Wendeschneidplatte	Yedek Parçaları / Spare Parts / Ersatzteile						
	R	L	HF=H	B	LF	WF		Baskı Pabucu Wedge Clamp Spannpratze	Pabuç Vidası Clamp Screw Klemmschraube	Altlık Shim Unterlage	Altlık Vidası Shim Screw Schraube für Unterlage	Segman Ring Feder	Pul Stamp Ring	Anahtar Allen Key Innenschlankschlüssel
TTGNR/L 2020 K16	●	●	20	20	125	25	TN.. 1604..					-	ABPL-01	AAL-03-3
TTGNR/L 2525 M16	●	●	25	25	150	32								
TTGNR/L 3232 P16	●	●	32	32	170	40								
TTGNR/L 2525 M22	●	●	25	25	150	32	TN.. 2204...					AS-01	ABPL-01	AAL-03-3
TTGNR/L 3232 P22	●	●	32	32	170	40								
TTGNR/L 4040 S22	●	○	40	40	250	50								

R: Sağ / Right / Rechts L: Sol / Left / Links

● Stokta / In Stock / Auf Lager ○ Stokta Yok / Non Stock Item / Kein Lagerartikel, Lieferzeit auf Anfrage

Sipariş Örneği/Ordering Example/Bestellbeispiel

1 ad./pcs./stück TTENN 2020 K16

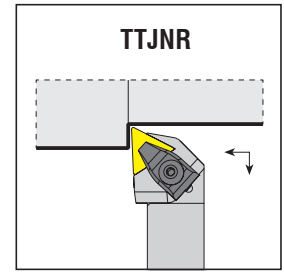
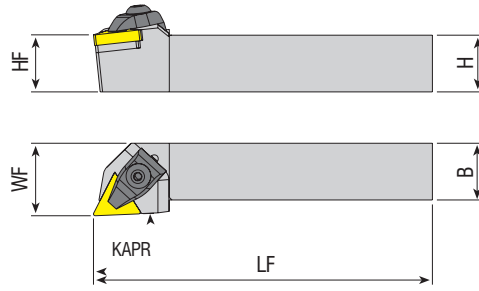
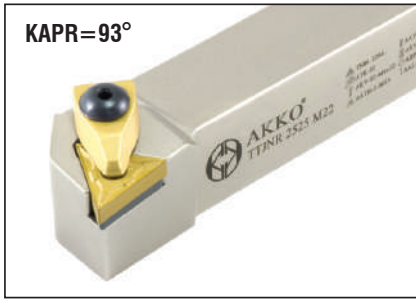

Takım Kodu Ordering Code Bestell-Bezeichnung	Stok Stock Lager		Takım Ölçüleri (mm) Dimension (mm) Abmessung (mm)				Kesici Uç Insert Wendeschneidplatte	Yedek Parçaları / Spare Parts / Ersatzteile						
	R	L	HF=H	B	LF	WF		Baskı Pabucu Wedge Clamp Spannpratze	Pabuç Vidası Clamp Screw Klemmschraube	Altlık Shim Unterlage	Altlık Vidası Shim Screw Schraube für Unterlage	Segman Ring Feder	Pul Stamp Ring	Anahtar Allen Key Innensechskantschlüssel
TTJNR/L 2020 K16	●	●	20	20	125	25	TN.. 1604..	ATK-01	AKV-01-M5x22	AATN-2-0002	AAV-03-M5x12	-	ABPL-01	AAL-03-3
TTJNR/L 2525 M16	●	●	25	25	150	32								
TTJNR/L 3232 P16	●	●	32	32	170	40								
TTJNR/L 2525 M22	●	●	25	25	150	32	TN.. 2204...	ATK-02	AKV-30-M6x22	AATN-3-0015	AAV-02-M5x12	AS-01	ABPL-01	AAL-03-3
TTJNR/L 3232 P22	●	●	32	32	170	40								
TTJNR/L 4040 S22	○	○	40	40	250	50								

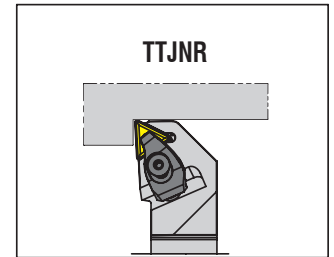
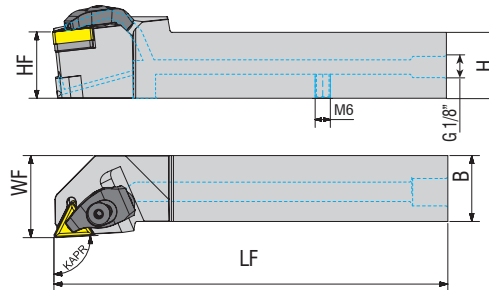

Takım Kodu Ordering Code Bestell-Bezeichnung	Stok Stock Lager		Takım Ölçüleri (mm) Dimension (mm) Abmessung (mm)				Kesici Uç Insert Wendeschneidplatte	Yedek Parçaları / Spare Parts / Ersatzteile							
	R	L	HF=H	B	LF	WF		Baskı Pabucu Wedge Clamp Spannpratze	Pabuç Vidası Clamp Screw Klemmschraube	Altlık Shim Unterlage	Altlık Vidası Shim Screw Schraube für Unterlage	Yay Spring Feder	Oring Ring Feder	Sızdırmaz Vida Threaded Pin Gewindestift	Anahtar Allen Key Innensechskantschlüssel
TTJNR/L 2525 M16-H	○	○	25	25	150	32	TN.. 1604..	ATKH-03-R	AKV-37-M5x18	AATN-2-0002	AAV-03-M5x12	AKY-02	AXR-02	2705-G1/8x5.5	AAL-02-2.5
TTJNR/L 3232 P16-H	○	○	32	32	170	32		ATKH-04-L							
TTJNR/L 2525 M22-H	○	○	25	25	150	40	TN.. 2204...	ATKH-01-R	AKV-33-M6x22	AATN-3-0015	AAV-02-M5x12	AKY-01	AXR-01		AAL-03-3
TTJNR/L 3232 P22-H	○	○	32	32	170	40		ATKH-02-L							

R: Sağ / Right / Rechts L: Sol / Left / Links

● Stokta / In Stock / Auf Lager ○ Stokta Yok / Non Stock Item / Kein Lagerartikel, Lieferzeit auf Anfrage

VDI tutucu ile uyumludur. / Compatible with VDI holders. / Kompatibel mit VDI Werkzeughalter.

Sipariş Örneği/Ordering Example/Bestellbeispiel

1 ad./pcs./stück TTJNR 2020 K16

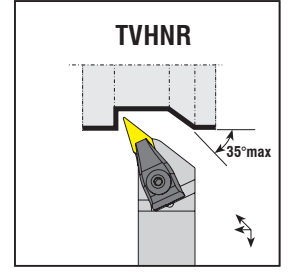
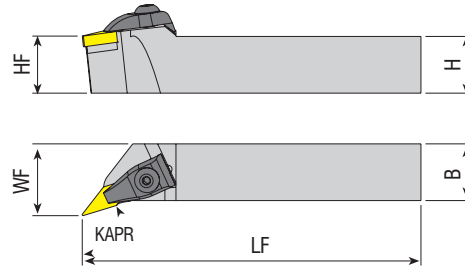

Takım Kodu Ordering Code Bestell-Bezeichnung	Stok Stock Lager		Takım Ölçüleri (mm) Dimension (mm) Abmessung (mm)				Kesici Uç Insert Wendeschneidplatte	Baskı Pabuçu Wedge Clamp Spannpratze	Pabuç Vidası Clamp Screw Klemmschraube	Altık Shim Unterlage	Altık Vidası Shim Screw Schraube für Unterlage	Segman Ring Feder	Pul Stamp Ring	Anahtar Allen Key Innensechskantschlüssel
	R	L	HF=H	B	LF	WF								
TVHNR/L 2020 K16	●	●	20	20	125	25	VN.. 1604..	ATK-03	AKV-30-M6x22	AAVN-2-0002	AAV-04-M5x12	AS-01	ABPL-01	AAL-03-3
TVHNR/L 2525 M16	●	●	25	25	150	32								
TVHNR/L 3232 P16	●	●	32	32	170	40								

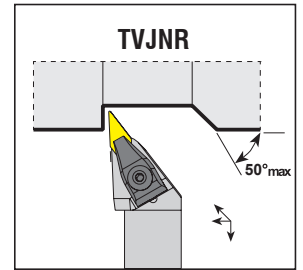
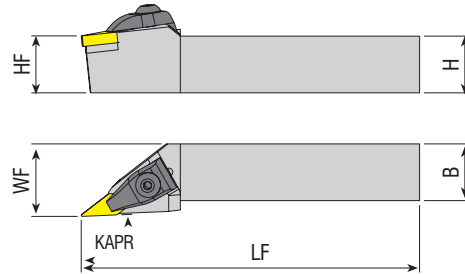

Takım Kodu Ordering Code Bestell-Bezeichnung	Stok Stock Lager		Takım Ölçüleri (mm) Dimension (mm) Abmessung (mm)				Kesici Uç Insert Wendeschneidplatte	Baskı Pabuçu Wedge Clamp Spannpratze	Pabuç Vidası Clamp Screw Klemmschraube	Altık Shim Unterlage	Altık Vidası Shim Screw Schraube für Unterlage	Segman Ring Feder	Pul Stamp Ring	Anahtar Allen Key Innensechskantschlüssel
	R	L	HF=H	B	LF	WF								
TVJNR/L 2020 K16	●	●	20	20	125	25	VN.. 1604..	ATK-03	AKV-30-M6x22	AAVN-2-0002	AAV-04-M5x12	AS-01	ABPL-01	AAL-03-3
TVJNR/L 2525 M16	●	●	25	25	150	32								
TVJNR/L 3232 P16	●	●	32	32	170	40								

R: Sağ / Right / Rechts L: Sol / Left / Links

● Stokta / In Stock / Auf Lager ○ Stokta Yok / Non Stock Item / Kein Lagerartikel, Lieferzeit auf Anfrage

Sipariş Örneği/Ordering Example/Bestellbeispiel

1 ad./pcs./stück TVHNR 2020 K16

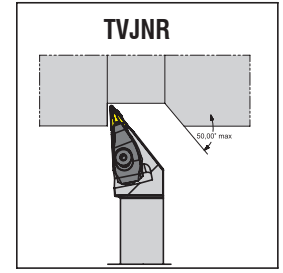
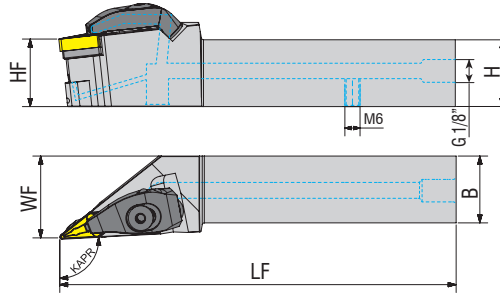

Takım Kodu Ordering Code Bestell-Bezeichnung	Stok Stock Lager		Takım Ölçüleri (mm) Dimension (mm) Abmessung (mm)				Kesici Uç Insert Wendeschneidplatte	Yedek Parçaları / Spare Parts / Ersatzteile															
	R	L	HF=H	B	LF	WF		Baskı Pabucu Wedge Clamp Spannpratze	Pabuç Vidası Clamp Screw Klemmschraube	Altlık Shim Unterlage	Altlık Vidası Shim Screw Schraube für Unterlage	Yay Spring Feder	Oring Ring Feder	Sızdırmaz Vida Threaded Pin Gewindestift	Anahtar Allen Key Innensechskantschlüssel								
TVJNR/L 2020 K16-H	○	○	20	20	125	25	VN.. 1604..																
TVJNR/L 2525 M16-H	○	○	25	25	150	32										ATKH-05-R	AKV-33-M6x22	AAVN-2-0002	AAV-04-M5x12	AKY-01	AXR-01	2705-G1/8x5.5	AAL-03-3
TVJNR/L 3232 P16-H	○	○	32	32	170	40										ATKH-06-L							

VDI tutucu ile uyumludur. / Compatible with VDI holders. / Kompatibel mit VDI Werkzeughalter.

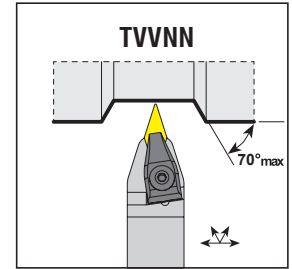
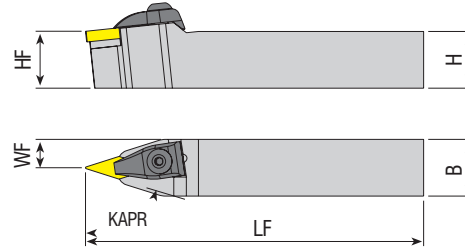

Takım Kodu Ordering Code Bestell-Bezeichnung	Stok Stock Lager		Takım Ölçüleri (mm) Dimension (mm) Abmessung (mm)				Kesici Uç Insert Wendeschneidplatte	Yedek Parçaları / Spare Parts / Ersatzteile													
			HF=H	B	LF	WF		Baskı Pabucu Wedge Clamp Spannpratze	Pabuç Vidası Clamp Screw Klemmschraube	Altlık Shim Unterlage	Altlık Vidası Shim Screw Schraube für Unterlage	Segman Ring Feder	Pul Stamp Ring	Anahtar Allen Key Innensechskantschlüssel							
TVVNN 2020 K16	●		20	20	125	10	VN.. 1604..														
TVVNN 2525 M16	●		25	25	150	12.5									ATK-03	AKV-30-M6x22	AAVN-2-0002	AAV-04-M5x12	AS-01	ABPL-01	AAL-03-3
TVVNN 3232 P16	●		32	32	170	16															

R: Sağ / Right / Rechts L: Sol / Left / Links

● Stokta / In Stock / Auf Lager ○ Stokta Yok / Non Stock Item / Kein Lagerartikel, Lieferzeit auf Anfrage

Sipariş Örneği/Ordering Example/Bestellbeispiel

1 ad./pcs./stück TVJNR 2020 K16-H

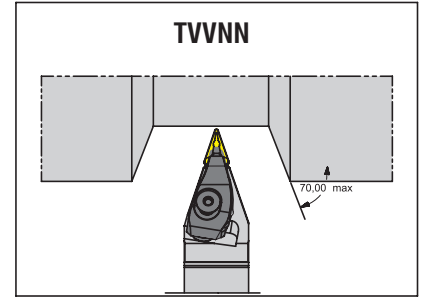
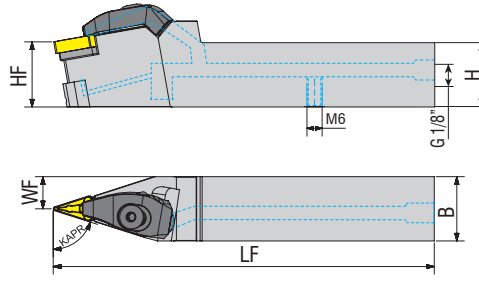
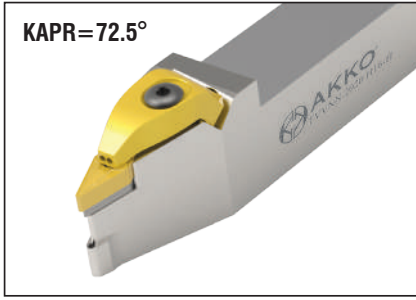

Takım Kodu Ordering Code Bestell-Bezeichnung	Stok Stock Lager	Takım Ölçüleri (mm) Dimension (mm) Abmessung (mm)				Kesici Uç Insert Wendescheidplatte	Yedek Parçaları / Spare Parts / Ersatzteile							
		HF=H	B	LF	WF		Baskı Pabucu Wedge Clamp Spannpratze	Pabuç Vidası Clamp Screw Klemmschraube	Altlık Shim Unterlage	Altlık Vidası Shim Screw Schraube für Unterlage	Yay Spring Feder	Oring Ring Feder	Sızdırmaz Vidası Threaded Pin Gewindestift	Anahtar Allen Key Innensechskantschlüssel
TVVNN 2020 K16-H	○	20	20	125	10	VN.. 1604..	ATKH-05-R ATKH-06-L	AKV-33-M6x22	AAVN-2-0002	AAV-04-M5x12	AKY-01	AXR-01	2705-G1/8x5.5	AAL-03-3
TVVNN 2525 M16-H	○	25	25	150	12.7									

VDI tutucu ile uyumludur. / Compatible with VDI holders. / Kompatibel mit VDI Werkzeughalter.

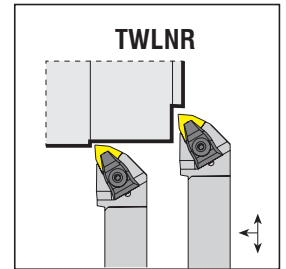
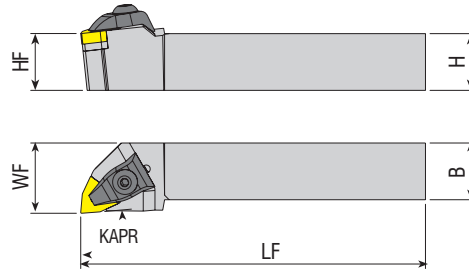

Takım Kodu Ordering Code Bestell-Bezeichnung	Stok Stock Lager		Takım Ölçüleri (mm) Dimension (mm) Abmessung (mm)				Kesici Uç Insert Wendescheidplatte	Yedek Parçaları / Spare Parts / Ersatzteile							
	R	L	HF=H	B	LF	WF		Baskı Pabucu Wedge Clamp Spannpratze	Pabuç Vidası Clamp Screw Klemmschraube	Altlık Shim Unterlage	Altlık Vidası Shim Screw Schraube für Unterlage	Segman Ring Feder	Pul Stamp Ring	Anahtar Allen Key Innensechskantschlüssel	
TWLNR/L 1616 H06	●	●	16	16	100	20	WN.. 0604..	ATK-01	AKV-01-M5x22	AAVN-SW317	AAV-01-M3x10	-	ABPL-01	AAL-03-3	
TWLNR/L 2020 K06	●	●	20	20	125	25									
TWLNR/L 2525 M06	●	●	25	25	150	32									
TWLNR/L 2020 K08	●	●	20	20	125	25	WN.. 0804..	ATK-02	AKV-30-M6x22	AAVN-3-0001	AAV-02-M5x12	AS-01	ABPL-01	AAL-03-3	
TWLNR/L 2525 M08	●	●	25	25	150	32									
TWLNR/L 3232 P08	●	●	32	32	170	40									
TWLNR/L 4040 S08	●	●	40	40	250	50									
TWLNR/L 5050 S08	○	○	50	50	250	60									

R: Sağ / Right / Rechts L: Sol / Left / Links

● Stokta / In Stock / Auf Lager ○ Stokta Yok / Non Stock Item / Kein Lagerartikel, Lieferzeit auf Anfrage

Sipariş Örneği/Ordering Example/Bestellbeispiel

1 ad./pcs./stück TVVNN 2020 K16-H

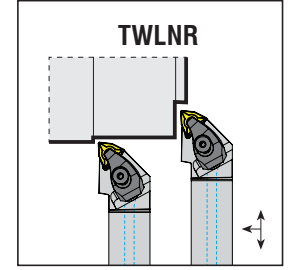
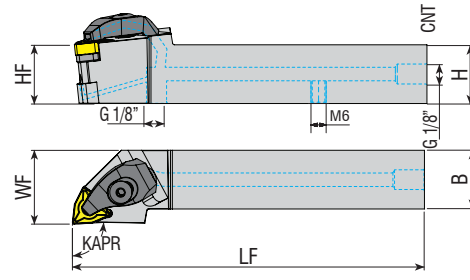

Takım Kodu
Ordering Code
Bestell-Bezeichnung

Stok Stock Lager		Takım Ölçüleri (mm) Dimension (mm) Abmessung (mm)				Kesici Uç Insert Wendeschneidplatte	Yedek Parçaları / Spare Parts / Ersatzteile							
R	L	HF=H	B	LF	WF		Baskı Pabuçu Wedge Clamp Spannpratze	Pabuç Vidası Clamp Screw Klemmschraube	Altlık Shim Unterlage	Altlık Vidası Shim Screw Schraube für Unterlage	Yay Spring Feder	Oring Ring Feder	Sızdırmaz Vida Threaded Pin Gewindestift	Anahtar Allen Key Innensechskantschlüssel
●	●	20	20	125	25									
●	●	25	25	150	32	WN.. 0604..	ATKH-03-R	-	AAWN-SW317	AAV-01-M3X10	AKY-03	AXR-02		AXR-02
●	●	32	32	170	40								2705-G1/8x5.5	
●	●	20	20	125	25									
●	●	25	25	150	32	WN.. 0804..	ATKH-01-R	AKV-33-M6x22	AAWN-3-0001	AAV-13-M5x8	AKY-01	AXR-01		AAL-03-3
●	●	32	32	170	40									

R: Sağ / Right / Rechts L: Sol / Left / Links

● Stokta / In Stock / Auf Lager ○ Stokta Yok / Non Stock Item / Kein Lagerartikel, Lieferzeit auf Anfrage
VDI tutucu ile uyumludur. / Compatible with VDI holders. / Kompatibel mit VDI Werkzeughalter.

Sipariş Örneği/Ordering Example/Bestellbeispiel
1 ad./pcs./stück TWLNR 2020 K06-H



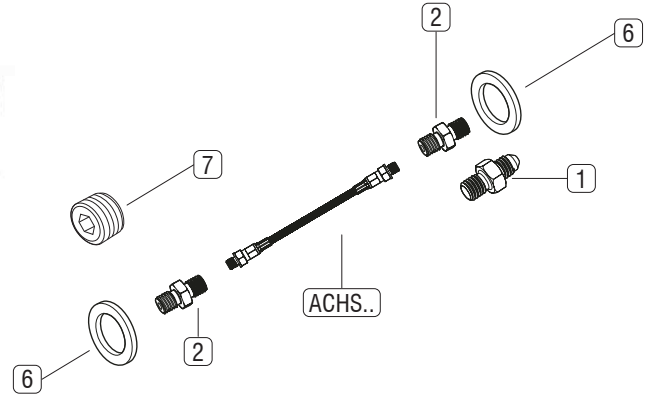
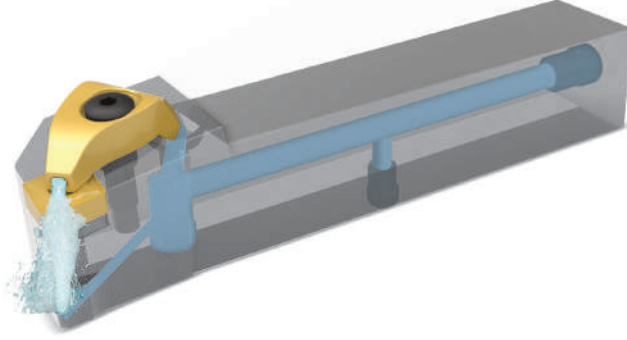

Not: İçten soğutmalı tüm torna katerlerinde kullanılabilecek 3 tip soğutma hortum setleri tasarlanmıştır. Takımların kullanılmasından önce, kullanılmayan bağlantıların set içindeki vida ile kapatılarak sızdırmazlığın sağlanmasına dikkat edilmelidir. Torna katerlerine yönelik soğutma hortum setleri, ACHS... 10 bar ile maksimum 150 bar basınç aralığında kullanılabilir.

Note: 3 types of cooling hose sets are designed that can be used in all internally cooled lathes. Before using the tools, care should be taken to ensure that the unused connections are closed with the screw in the set and that sealing is ensured. Cooling hose sets for lathe tools can be used in the pressure range of ACHS ... 10 bar to max 150 bar.

Notiz: Es wurden 3 Arten von Kühlschlauch-Sets entwickelt, die in allen intern gekühlten Drehmaschinen verwendet werden können. Vor der Verwendung der Werkzeuge sollte darauf geachtet werden, dass die nicht verwendeten Verbindungen mit der Schraube im Satz geschlossen werden und die Abdichtung gewährleistet ist. Kühlschlauchsätze für Drehmaschinen können im Druckbereich von ACHS ... 10 bar bis max. 150 bar eingesetzt werden.

Set İçindeki Parçalar Parts In The Set Teile im Set				Uzunluk / Length Code / Länge		
				Set Kodu: Set Code: Code Einstellen: ACHS-1-250	Set Kodu: Set Code: Code Einstellen: ACHS-2-250	Set Kodu: Set Code: Code Einstellen: ACHS-3-250
	Resim Picture Bild	Takım Kodu Set Code Code Einstellen	Ürün Açıklaması Product Description Artikelbeschreibung			
1		AMP-01	M10 Bağlantı Elemanı M10 Fastener M10 Verschluss	1x	-	-
2		AMP-02	G 1/8" Çift Bağlantı Elemanı G 1/8" Double Fastener G 1/8" Doppelverschluss	2x	1x	-
3		AMP-03	G 1/8" Açılı Bağlantısı G 1/8" Angle Connection G 1/8" Winkelverbindung	-	1x	2x
4		AMP-04	M10" Açılı Bağlantısı M10" Angle Connection M10" Winkelverbindung	-	1x	1x
5		AMP-05	G1/4"-G1/8" Kılcalma Parçası G1 / 4"-G1/8" Capillary Piece G1 / 4"-G1/8" Kapillarstück	-	1x	1x
6		AG-01	Bakır Conta Copper Gasket Kupferdichtung	2x	3x	4x
7		2705-G1/8-5.5	G1/8" Sızdırmaz Civata G1/8" Sealing Bolt G1/8" Dichtungsschraube	1x	1x	1x
8		AH-1-250	Hortum Hose Schlauch	1x	-	-
9		AH-2-250	Hortum Hose Schlauch	-	1x	-
10		AH-3-250	Hortum Hose Schlauch	-	-	1x

M-SİSTEM

M-SİSTEM DIŞ TORNA KATERLERİ
M-SYSTEM EXTERNAL TURNING TOOLHOLDERS
M-SYSTEM AUSSEN - DREHHALTER

konusulan
the spoken kalite...
quality...



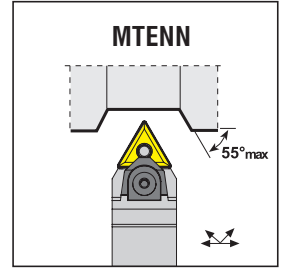
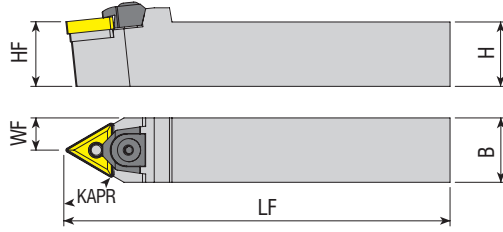

Takım Kodu Ordering Code Bestell-Bezeichnung	Stok Stock Lager		Takım Ölçüleri (mm) Dimension (mm) Abmessung (mm)				Kesici Uç Insert Wendeschneidplatte	Baskı Pabucu Wedge Clamp Spannpratze	Pabuç Vidası Clamp Screw Klemmschraube	Altlık Shim Unterlage	Pim Pin Stift	Segman Ring Feder	Pul Stamp Ring	Anahtar Allen Key Innensechskantschlüssel
	HF=H	B	LF	WF	HF=H	B								
MTENN 2020 K16	●		20	20	125	10	TN.. 1604..	AMK-04	AKV-30-M6x22	AATN-2-0002	APM-01	AS-01	ABPL-01	AAL-03-3
MTENN 2525 M16	●		25	25	150	12.5								
MTENN 3232 P16	●		32	32	170	16								
MTENN 2525 M22	●		25	25	150	12.5	TN.. 2204...	AMK-08	AKV-30-M6x22	AATN-3-0015	APM-02	AS-01	ABPL-01	AAL-03-3
MTENN 3232 P22	●		32	32	170	16								
MTENN 4040 S22	●		40	40	250	20								

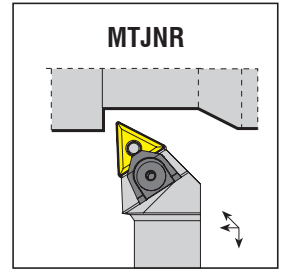
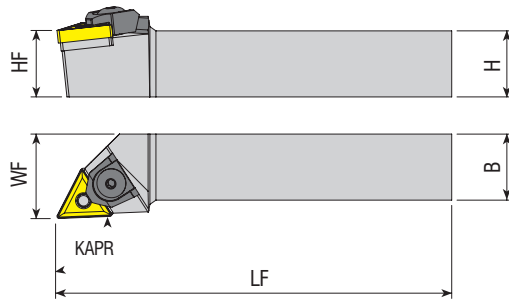
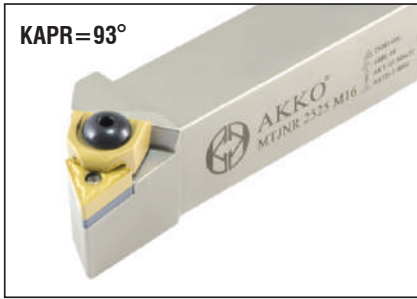

Takım Kodu Ordering Code Bestell-Bezeichnung	Stok Stock Lager		Takım Ölçüleri (mm) Dimension (mm) Abmessung (mm)				Kesici Uç Insert Wendeschneidplatte	Baskı Pabucu Wedge Clamp Spannpratze	Pabuç Vidası Clamp Screw Klemmschraube	Altlık Shim Unterlage	Pim Pin Stift	Segman Ring Feder	Pul Stamp Ring	Anahtar Allen Key Innensechskantschlüssel
	R	L	HF=H	B	LF	WF								
MTJNR/L 2020 K16	●	●	20	20	125	25	TN.. 1604..	AMK-04	AKV-30-M6x22	AATN-2-0002	APM-01	AS-01	ABPL-01	AAL-03-3
MTJNR/L 2525 M16	●	●	25	25	150	32								
MTJNR/L 3232 P16	●	●	32	32	170	40								
MTJNR/L 2525 M22	●	●	25	25	150	32	TN.. 2204...	AMK-08	AKV-30-M6x22	AATN-3-0015	APM-02	AS-01	ABPL-01	AAL-03-3
MTJNR/L 3232 P22	●	●	32	32	170	40								
MTJNR/L 4040 S22	●	●	40	40	250	50								

R: Sağ / Right / Rechts L: Sol / Left / Links

● Stokta / In Stock / Auf Lager ○ Stokta Yok / Non Stock Item / Kein Lagerartikel, Lieferzeit auf Anfrage

Sipariş Örneği/Ordering Example/Bestellbeispiel

1 ad./pcs./stück MTENN 2020 K16



*konusulan
the spoken kalite...
quality...*

P-SİSTEM

P-SİSTEM DIŞ TORNA KATERLERİ
P-SYSTEM EXTERNAL TURNING TOOLHOLDERS
P-SYSTEM AUSSEN - DREHHALTER

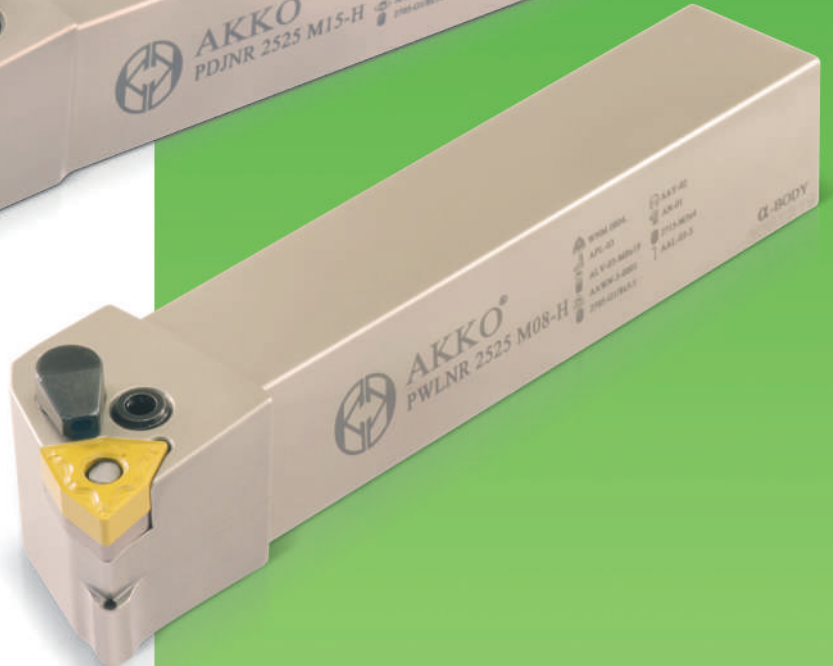

DETAYLI BİLGİ İÇİN BARKODU OKUTUNUZ

SCAN ME FOR MORE DETAILS

FÜR DETAILS BITTE DEN QR CODE SCANNEN



KAPR=75°

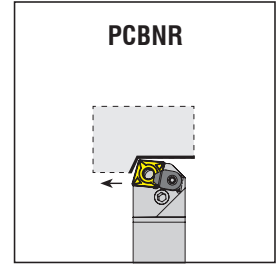
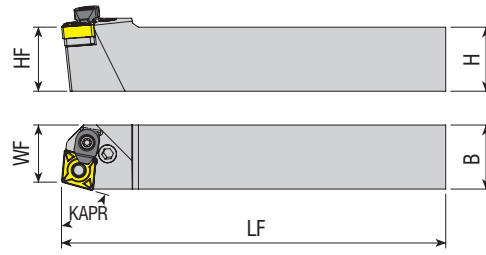

PCBNR

Takım Kodu Ordering Code Bestell-Bezeichnung	Stok Stock Lager		Takım Ölçüleri (mm) Dimension (mm) Abmessung (mm)				Kesici Uç Insert Wendeschneidplatte	Yedek Parçaları / Spare Parts / Ersatzteile						
	R	L	HF=H	B	LF	WF		Levyeye Lever Kniehebel	Levyeye Vidası Lever Screw Kniehebelschraube	Altılık Shim Unterlage	Altılık Yayı Shim Spring Feder für Unterlage	Baskı Parçası Wedge Clamp Spannpratze	Baskı Vidası Clamp Screw Klemmschraube	Anahtar Allen Key Innensechskantschlüssel
PCBNR/L 2020 K12C	●	●	20	20	125	17.5	CN.. 1204..	APL-02	ALV-03-M8x19	AACN-3-0001	AAY-02	ACK-05	4015-M4x11	AAL-03-3
PCBNR/L 2525 M12C	●	●	25	25	150	22.5								
PCBNR/L 3232 P12C	●	●	32	32	170	29.5								
PCBNR/L 2525 M16C	●	●	25	25	150	22	CN.. 1606..	APL-04	ALV-04-M8x22	AACN-3-0002	AAY-03	ACK-09	AAV-05-M6x15	AAL-05-4
PCBNR/L 3232 P16C	●	●	32	32	170	27								
new PCBNR/L 2525 P19C	●	○	25	25	170	20	CN.. 1906..	APL-05	ALV-05-M10x27	AACN-3-0003	AAY-04	ACK-09	AAV-05-M6x15	AAL-05-4
PCBNR/L 3232 P19C	●	●	32	32	170	27								
PCBNR/L 4040 S19C	●	●	40	40	250	37	CN.. 2509..	APL-06	ALV-06-M12x36	AACN-3-0008	AAY-05	ACK-04	AKV-16-M6x16	AAL-07-5
PCBNR/L 4040 S25C	●	●	40	40	250	37								
PCBNR/L 5050 S25C	○	○	50	50	250	47								



KAPR=95°

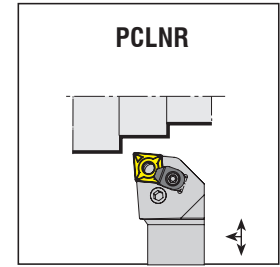
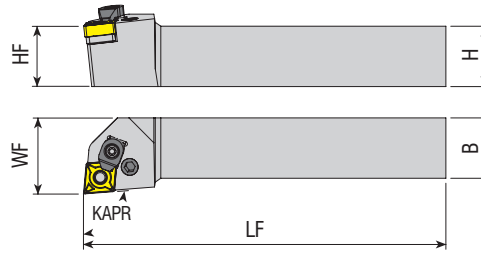

PCLNR

Takım Kodu Ordering Code Bestell-Bezeichnung	Stok Stock Lager		Takım Ölçüleri (mm) Dimension (mm) Abmessung (mm)				Kesici Uç Insert Wendeschneidplatte	Yedek Parçaları / Spare Parts / Ersatzteile						
	R	L	HF=H	B	LF	WF		Levyeye Lever Kniehebel	Levyeye Vidası Lever Screw Kniehebelschraube	Altılık Shim Unterlage	Altılık Yayı Shim Spring Feder für Unterlage	Baskı Parçası Wedge Clamp Spannpratze	Baskı Vidası Clamp Screw Klemmschraube	Anahtar Allen Key Innensechskantschlüssel
PCLNR/L 1616 H09	●	●	16	16	100	20	CN.. 0903..	APL-01	ALV-02-M6x17	AACN-2-0002	AAY-01	-	-	AAL-02-2.5
PCLNR/L 2020 K09	●	●	20	20	125	25								
PCLNR/L 2525 M09	●	●	25	25	150	32								
PCLNR/L 1616 H12	●	●	16	16	100	20	CN.. 1204..	APL-02	ALV-03-M8x19	AACN-3-0001	AAY-02	ACK-05	4015-M4x11	AAL-03-3
PCLNR/L 2020 K12C	●	●	20	20	125	25								
PCLNR/L 2525 M12C	●	●	25	25	150	32								
PCLNR/L 3232 P12C	●	●	32	32	170	40	CN.. 1606..	APL-04	ALV-04-M8x22	AACN-3-0002	AAY-03	ACK-09	AAV-05-M6x15	AAL-05-4
PCLNR/L 2525 M16C	●	●	25	25	150	32								
PCLNR/L 3232 P16C	●	●	32	32	170	40	CN.. 1906..	APL-05	ALV-05-M10x27	AACN-3-0003	AAY-04	ACK-09	AAV-05-M6x15	AAL-05-4
PCLNR/L 2525 M19C	●	●	25	25	150	32								
PCLNR/L 3232 P19C	●	●	32	32	170	40	CN.. 2509..	APL-06	ALV-06-M12x36	AACN-3-0008	AAY-05	ACK-04	AKV-16-M6x16	AAL-07-5
new PCLNR/L 4040 S19C	●	●	40	40	250	50								
PCLNR/L 5050 S19C	●	●	50	50	250	60								
PCLNR/L 4040 S25C	●	●	40	40	250	50								
PCLNR/L 5050 S25C	●	●	50	50	250	60								

R: Sağ / Right / Rechts L: Sol / Left / Links
● Stokta / In Stock / Auf Lager ○ Stokta Yok / Non Stock Item / Kein Lagerartikel, Lieferzeit auf Anfrage

Sipariş Örneği/Ordering Example/Bestellbeispiel
1 ad./pcs./stück PCBNR 2020 K12C

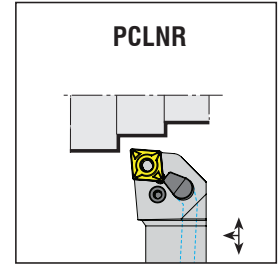
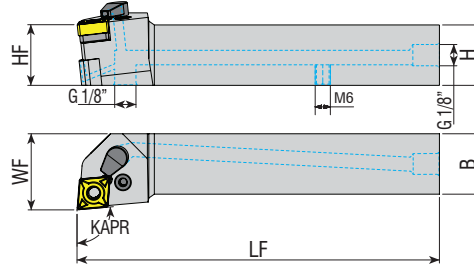

Takım Kodu Ordering Code Bestell-Bezeichnung	Stok Stock Lager		Takım Ölçüleri (mm) Dimension (mm) Abmessung (mm)				Kesici Uç Insert Wendeschneidplatte	Levyeye Lever Kniehebel	Levyeye Vidası Lever Screw Kniehebelschraube	Altılık Shim Unterlage	Altılık Yay Shim Spring Feder für Unterlage	Oring Ring Feder	Sızdırmaz Vida Threaded Pin Gewindestift	Nozul Spannpratze Spannpratze	Anahtar Allen Key Innensechskantschlüssel						
	R	L	HF=H	B	LF	WF															
PCLNR/L 2020 K12-H	●	●	20	20	125	25	CN.. 1204..	APL-02	ALV-03-M8x19	AACN-3-0001	AAY-02	AXR-01 AOR-01	2705-G1/8x5.5	AN-01	AAL-03-3						
PCLNR/L 2525 M12-H	●	●	25	25	150	32															
PCLNR/L 3232 P12-H	●	○	32	32	170	40															
PCLNR/L 3232 P16-H	●	○	32	32	170	40										CN.. 1606..	APL-04	ALV-04-M8x22	AACN-3-0002	AAY-03	AAL-03-4
PCLNR/L 3232 P19-H	●	○	32	32	170	40										CN.. 1906..	APL-05	ALV-05-M10x27	AACN-3-0003	AAY-04	

VDI tutucu ile uyumludur. / Compatible with VDI holders. / Kompatibel mit VDI Werkzeughalter.

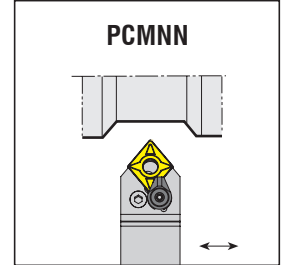
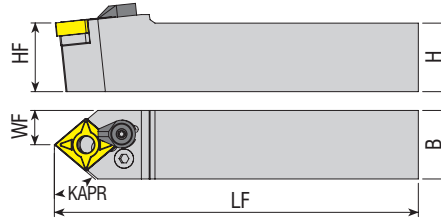

Takım Kodu Ordering Code Bestell-Bezeichnung	Stok Stock Lager	Takım Ölçüleri (mm) Dimension (mm) Abmessung (mm)				Kesici Uç Insert Wendeschneidplatte	Levyeye Lever Kniehebel	Levyeye Vidası Lever Screw Kniehebelschraube	Altılık Shim Unterlage	Altılık Yay Shim Spring Feder für Unterlage	Baskı Parçası Wedge Clamp Spannpratze	Baskı Vidası Clamp Screw Klemmschraube	Anahtar Allen Key Innensechskantschlüssel
		HF=H	B	LF	WF								
PCMNN 2020 K12C	●	20	20	125	10	CN.. 1204..	APL-02	ALV-03-M8x19	AACN-3-0001	AAY-02	ACK-05	4015-M4x11	AAL-03-3
PCMNN 2525 M12C	●	25	25	150	12.5								
PCMNN 3232 P12C	○	32	32	170	16								
PCMNN 2525 M16C	○	25	25	150	12.5	CN.. 1606..	APL-04	ALV-04-M8x22	AACN-3-0002	AAY-03	ACK-09	AAV-05-M6x15	AAL-05-4
PCMNN 3232 P16C	○	32	32	170	16								
PCMNN 3232 P19C	●	32	32	170	16	CN.. 1906..	APL-05	ALV-05-M10x27	AACN-3-0003	AAY-04	ACK-04	AKV-16-M6x16	AAL-07-5
PCMNN 4040 S19C	●	40	40	250	20								
PCMNN 5050 S19C	○	50	50	250	25	CN.. 2509..	APL-06	ALV-06-M12x36	AACN-3-0008	AAY-05	ACK-04	AKV-16-M6x16	AAL-07-5
PCMNN 4040 S25C	●	40	40	250	20								

R: Sağ / Right / Rechts L: Sol / Left / Links

● Stokta / In Stock / Auf Lager ○ Stokta Yok / Non Stock Item / Kein Lagerartikel, Lieferzeit auf Anfrage

Sipariş Örneği/Ordering Example/Bestellbeispiel

1 ad./pcs./stück PCLNR 2020 K12-H

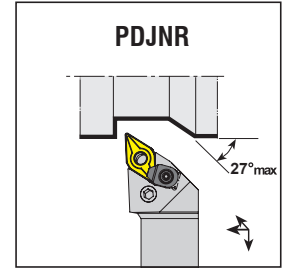
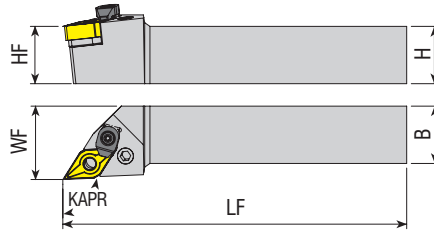

Takım Kodu Ordering Code Bestell-Bezeichnung	Stok Stock Lager		Takım Ölçüleri (mm) Dimension (mm) Abmessung (mm)				Kesici Uç Insert Wendeschneidplatte	Leyve Lever Kniehebel	Leyve Vidası Lever Screw Kniehebelschraube	Altlık Shim Unterlage	Altlık Yayı Shim Spring Feder für Unterlage	Baskı Parçası Wedge Clamp Spannpratze	Baskı Vidası Clamp Screw Klemmschraube	Anahtar Allen Key Inmenschenschlüssel
	R	L	HF=H	B	LF	WF								
PDJNR/L 1616 H11	●	●	16	16	100	20	DN.. 1104..	APL-01	ALV-02-M6x17	AADN-SD317	AAY-01	-	-	AAL-02-2.5
PDJNR/L 2020 K11	●	●	20	20	125	25								
PDJNR/L 2525 M11	●	●	25	25	150	32								
PDJNR/L 2020 K15C	●	●	20	20	125	25	DN.. 1506..	APL-03	ALV-03-M8x19	AADN-3-0001	AAY-02	ACK-05	4015-M4x11	AAL-03-3
PDJNR/L 2525 M15C	●	●	25	25	150	32								
PDJNR/L 3232 P15C	●	●	32	32	170	40								
PDJNR/L 4040 S15C	●	●	40	40	250	50								

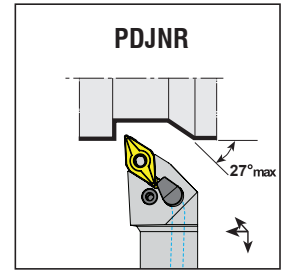
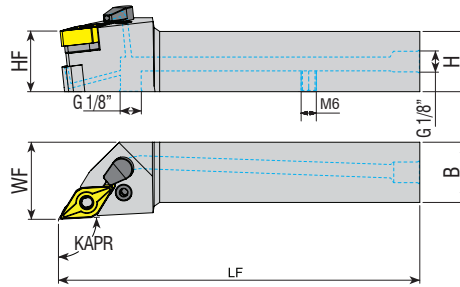

Takım Kodu Ordering Code Bestell-Bezeichnung	Stok Stock Lager		Takım Ölçüleri (mm) Dimension (mm) Abmessung (mm)				Kesici Uç Insert Wendeschneidplatte	Leyve Lever Kniehebel	Leyve Vidası Lever Screw Kniehebelschraube	Altlık Shim Unterlage	Altlık Yayı Shim Spring Feder für Unterlage	Oring Ring Feder	Sızdırmaz Vida Threaded Plug Gewindestift	Nozul Spannpratze	Anahtar Allen Key Inmenschenschlüssel
	R	L	HF=H	B	LF	WF									
PDJNR/L 2020 K15-H	●	●	20	20	125	25	DN.. 1506..	APL-03	ALV-03-M8x19	AADN-3-0001	AAY-02	AXR-01 AOR-01	2705-G1/8x5.5	AN-01	AAL-03-3
PDJNR/L 2525 M15-H	●	●	25	25	150	32									
PDJNR/L 3232 P15-H	●	○	32	32	170	40									

R: Sağ / Right / Rechts L: Sol / Left / Links
● Stokta / In Stock / Auf Lager ○ Stokta Yok / Non Stock Item / Kein Lagerartikel, Lieferzeit auf Anfrage
VDI tutucu ile uyumludur. / Compatible with VDI holders. / Kompatibel mit VDI Werkzeughalter.

Sipariş Örneği/Ordering Example/Bestellbeispiel
1 ad./pcs./stück PDJNR 1616 H11

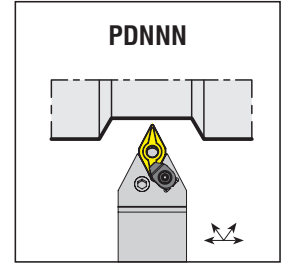
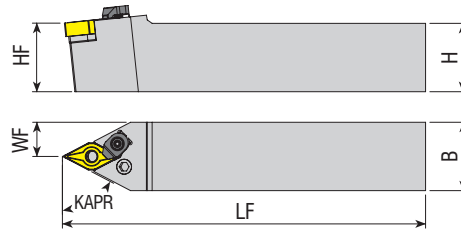

Takım Kodu Ordering Code Bestell-Bezeichnung	Stok Stock Lager	Takım Ölçüleri (mm) Dimension (mm) Abmessung (mm)				Kesici Uç Insert Wendeschneidplatte	Yedek Parçaları / Spare Parts / Ersatzteile						
		HF=H	B	LF	WF		Levyeye Lever Kniehebel	Levyeye Vidası Lever Screw Kniehebelschraube	Altılık Shim Unterlage	Altılık Yay Shim Spring Feder für Unterlage	Baskı Parçası Wedge Clamp Spannpratze	Baskı Vidası Clamp Screw Klemmschraube	Anahtar Allen Key Innensechskantschlüssel
PDN116 1616 H11	●	16	16	100	8	DN.. 1104..	APL-01	ALV-02-M6x17	AADN-SD317	AAY-01	-	-	AAL-02-2.5
PDN116 2020 K11	●	20	20	125	10								
PDN116 2525 M11	●	25	25	150	12.5								
PDN116 2020 K15C	●	20	20	125	10	DN.. 1506..	APL-03	ALV-03-M8x19	AADN-3-0001	AAY-02	ACK-05	4015-M4x11	AAL-03-3
PDN116 2525 M15C	●	25	25	150	12.5								
PDN116 3232 P15C	●	32	32	170	16								

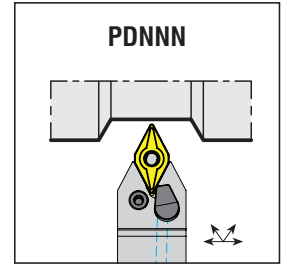
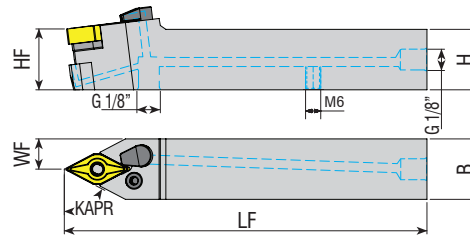

Takım Kodu Ordering Code Bestell-Bezeichnung	Stok Stock Lager	Takım Ölçüleri (mm) Dimension (mm) Abmessung (mm)				Kesici Uç Insert Wendeschneidplatte	Yedek Parçaları / Spare Parts / Ersatzteile									
		HF=H	B	LF	WF		Levyeye Lever Kniehebel	Levyeye Vidası Lever Screw Kniehebelschraube	Altılık Shim Unterlage	Altılık Yay Shim Spring Feder für Unterlage	Oring Ring Feder	Sızdırmaz Vida Threaded Pin Gewindestift	Nozul Spannpratze Spannpratze COX	Anahtar Allen Key Innensechskantschlüssel		
PDN255 2525 M15-H	●	25	25	150	12.5	DN.. 1506..	APL-03	ALV-03-M8x19	AADN-3-0001	AAY-02	AXR-01 AOR-01	2705-G1/8x5.5	AN-01	AAL-03-3		

R: Sağ / Right / Rechts L: Sol / Left / Links

● Stokta / In Stock / Auf Lager ○ Stokta Yok / Non Stock Item / Kein Lagerartikel, Lieferzeit auf Anfrage
VDI tutucu ile uyumludur. / Compatible with VDI holders. / Kompatibel mit VDI Werkzeughalter.

Sipariş Örneği/Ordering Example/Bestellbeispiel
1 ad./pcs./stück PDN116 1616 H11



KAPR=45°

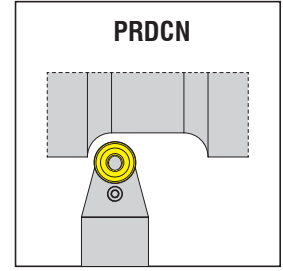
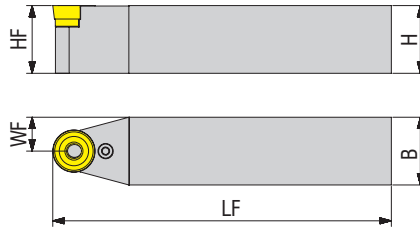
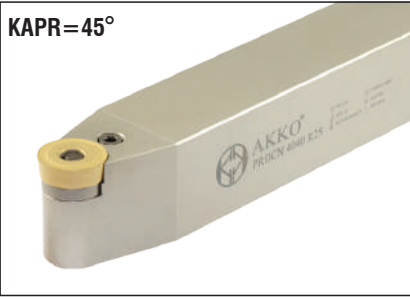

Takım Kodu Ordering Code Bestell-Bezeichnung	Stok Stock Lager	Takım Ölçüleri (mm) Dimension (mm) Abmessung (mm)				Kesici Uç Insert Wendeschneidplatte	Levyeye Lever Kniehebel	Levyeye Vidası Lever Screw Kniehebelschraube	Altılık Shim Unterlage	Altılık Yayı Shim Spring Feder für Unterlage	Anahtar Allen Key Innensechskantschlüssel
		HF=H	B	LF	WF						
PRDCN 4040 R25	●	40	40	200	20	RCM. 250700	APL-12	ALV-05-M10x27	AARN-1-0002	AAV-04	AAL-05-4
PRDCN 5050 T32	●	50	50	300	25	RCM. 320905	APL-13	ALV-06-M12x36	AARN-1-0001	AAV-05	AAL-07-5

KAPR=75°

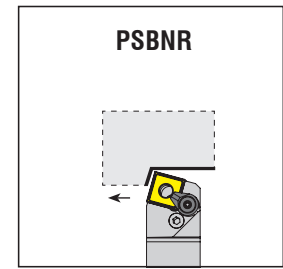
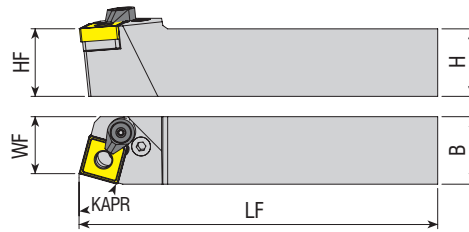

Takım Kodu Ordering Code Bestell-Bezeichnung	Stok Stock Lager		Takım Ölçüleri (mm) Dimension (mm) Abmessung (mm)				Kesici Uç Insert Wendeschneidplatte	Levyeye Lever Kniehebel	Levyeye Vidası Lever Screw Kniehebelschraube	Altılık Shim Unterlage	Altılık Yayı Shim Spring Feder für Unterlage	Baskı Parçası Wedge Clamp Spannpratze	Baskı Vidası Clamp Screw Klemmschraube	Anahtar Allen Key Innensechskantschlüssel
	R	L	HF=H	B	LF	WF								
PSB NR/L 1616 H09	●	●	16	16	100	13	SN.. 0903..	APL-01	ALV-02-M6x17	AASN-2-0002	AAV-01	-	-	AAL-02-2.5
PSB NR/L 2020 K09	○	○	20	20	125	17								
PSB NR/L 2020 K12	●	●	20	20	125	17	SN.. 1204..	APL-02	ALV-03-M8x19	AASN-3-0004	AAV-02	ACK-05	4015-M4x11	AAL-03-3
PSB NR/L 2525 M12C	●	●	25	25	150	22								
PSB NR/L 3232 P12C	●	●	32	32	170	27	SN.. 1506..	APL-04	ALV-04-M8x22	AASN-3-0023	AAV-03	-	-	AAL-05-4
PSB NR/L 2525 M15	●	●	25	25	150	22								
PSB NR/L 3232 P15C	●	●	32	32	170	27	SN.. 1906..	APL-05	ALV-05-M10x27	AASN-3-0005	AAV-04	ACK-09	AAV-05-M6x15	AAL-05-4
PSB NR/L 3232 P19C	●	●	32	32	170	27								
PSB NR/L 4040 S19C	●	●	40	40	250	35	SN.. 2509..	APL-06	ALV-06-M12x36	AASN-3-0020	AAV-05	ACK-04	AKV-16-M6x16	AAL-07-5
PSB NR/L 5050 S19C	●	●	50	50	250	45								
PSB NR/L 4040 S25C	●	●	40	40	250	35	SN.. 2507..	APL-06	ALV-06-M12x36	AASN-3-0005	AAV-05	ACK-04	AKV-16-M6x16	AAL-07-5
PSB NR/L 5050 S25C	●	○	50	50	250	43								
PSB NR/L 5050 S2507C	●	●	50	50	250	43	SN.. 2507..	APL-06	ALV-06-M12x36	AASN-3-0005	AAV-05	ACK-04	AKV-16-M6x16	AAL-07-5

R: Sağ / Right / Rechts L: Sol / Left / Links

● Stokta / In Stock / Auf Lager ○ Stokta Yok / Non Stock Item / Kein Lagerartikel, Lieferzeit auf Anfrage

Sipariş Örneği/Ordering Example/Bestellbeispiel

1 ad./pcs./stück PRDCN 4040 R25

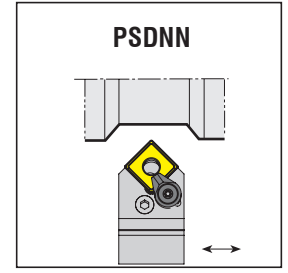
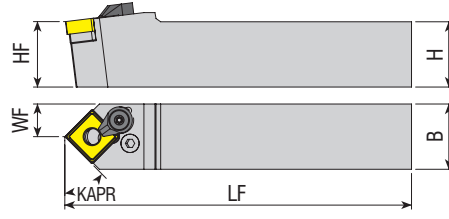

Takım Kodu Ordering Code Bestell-Bezeichnung	Stok Stock Lager		Takım Ölçüleri (mm) Dimension (mm) Abmessung (mm)				Kesici Uç Insert Wendeschneidplatte	Levyeye Lever Kniehebel	Levyeye Vidası Lever Screw Kniehebelschraube	Altılık Shim Unterlage	Altılık Yay Shim Spring Feder für Unterlage	Baskı Parçası Wedge Clamp Spannpratze	Baskı Vidası Clamp Screw Klemmschraube	Anahtar Allen Key Innensechskantschlüssel
	HF=H	B	LF	WF										
PSDNN 1616 H09	●		16	16	100	8	SN.. 0903..	APL-01	ALV-02-M6x17	AASN-2-0002	AAY-01	-	-	AAL-02-2.5
PSDNN 2020 K12C	●		20	20	125	10	SN.. 1204..	APL-02	ALV-03-M8x19	AASN-3-0004	AAY-02	ACK-05	4015-M4x11	AAL-03-3
PSDNN 2525 M12C	●		25	25	150	12.5								
PSDNN 3232 P12C	●		32	32	170	16								
PSDNN 2020 K15	●		20	20	125	10	SN.. 1506..	APL-04	ALV-04-M8x22	AASN-3-0023	AAY-03	-	-	AAL-03-3
PSDNN 2525 M15C	●		25	25	150	12.5								
PSDNN 3232 P19C	●		32	32	170	16	SN.. 1906..	APL-05	ALV-05-M10x27	AASN-3-0005	AAY-04	ACK-09	AAV-05-M6x15	AAL-05-4
PSDNN 4040 S19C	○		40	40	250	20								
PSDNN 5050 S19C	○		50	50	250	25								
PSDNN 4040 S25C	●		40	40	250	20	SN.. 2509..	APL-06	ALV-06-M12x36	AASN-3-0020	AAY-05	ACK-04	AKV-16-M6x16	AAL-07-5
PSDNN 5050 S25C	○		50	50	250	25								

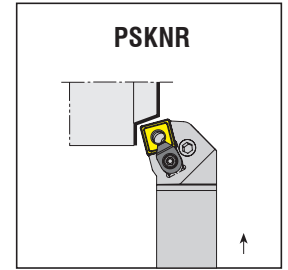
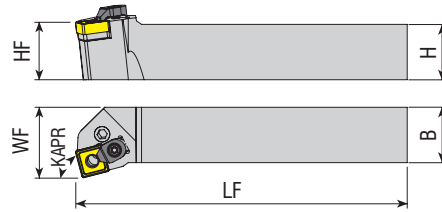

Takım Kodu Ordering Code Bestell-Bezeichnung	Stok Stock Lager		Takım Ölçüleri (mm) Dimension (mm) Abmessung (mm)				Kesici Uç Insert Wendeschneidplatte	Levyeye Lever Kniehebel	Levyeye Vidası Lever Screw Kniehebelschraube	Altılık Shim Unterlage	Altılık Yay Shim Spring Feder für Unterlage	Baskı Parçası Wedge Clamp Spannpratze	Baskı Vidası Clamp Screw Klemmschraube	Anahtar Allen Key Innensechskantschlüssel
	R	L	HF=H	B	LF	WF								
PSKNR/L 2020 K09	●	○	20	20	125	25	SN.. 0903..	APL-01	ALV-02-M6x17	AASN-2-0002	AAY-01	-	-	AAL-02-2.5
PSKNR/L 2020 K12C	●	●	20	20	125	25	SN.. 1204..	APL-02	ALV-03-M8x19	AASN-3-0004	AAY-02	ACK-05	4015-M4x11	AAL-03-3
PSKNR/L 2525 M12C	●	●	25	25	150	32								
PSKNR/L 3232 P12C	●	●	32	32	170	40								
PSKNR/L 2525 M15C	●	●	25	25	150	32	SN.. 1506..	APL-04	ALV-04-M8x22	AASN-3-0023	AAY-03	-	-	AAL-03-3
PSKNR/L 3232 P15C	●	●	32	32	170	40								
PSKNR/L 3232 P19C	●	●	32	32	170	40	SN.. 1906..	APL-05	ALV-05-M10x27	AASN-3-0005	AAY-04	ACK-09	AAV-05-M6x15	AAL-05-4
PSKNR/L 4040 S19C	●	●	40	40	250	50								
PSKNR/L 4040 S25C	●	●	40	40	250	50								
PSKNR/L 5050 S25C	●	○	50	50	250	60	SN.. 2509..	APL-06	ALV-06-M12x36	AASN-3-0020	AAY-05	ACK-04	AKV-16-M6x16	AAL-07-5

R: Sağ / Right / Rechts L: Sol / Left / Links

● Stokta / In Stock / Auf Lager ○ Stokta Yok / Non Stock Item / Kein Lagerartikel, Lieferzeit auf Anfrage

Sipariş Örneği/Ordering Example/Bestellbeispiel

1 ad./pcs./stück PSDNN 1616 H09

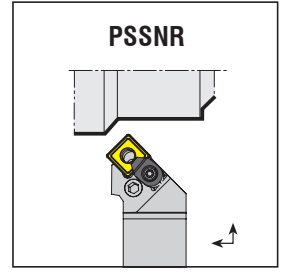
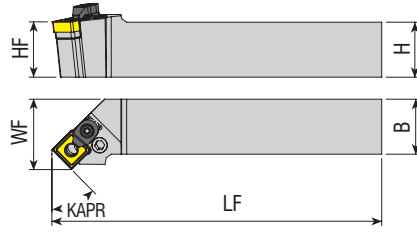

Takım Kodu Ordering Code Bestell-Bezeichnung	Stok Stock Lager		Takım Ölçüleri (mm) Dimension (mm) Abmessung (mm)				Kesici Uç Insert Wendeschneidplatte	Yedek Parçaları / Spare Parts / Ersatzteile						
	R	L	HF=H	B	LF	WF		Levyeye Lever Kniehebel	Levyeye Vidası Lever Screw Kniehebelschraube	Altılık Shim Unterlage	Altılık Yay Shim Spring Feder für Unterlage	Baskı Parçası Wedge Clamp Spannpratze	Baskı Vidası Clamp Screw Klemmschraube	Anahtar Allen Key Innerschraubschlüssel
	●	○												
PSSNR/L 1616 H09	●	●	16	16	100	20	SN.. 0903..	APL-01	ALV-02-M6x17	AASN-2-0002	AAY-01	-	-	AAL-02-2.5
PSSNR/L 2020 K09	●	○	20	20	125	25								
PSSNR/L 2020 K12C	●	●	20	20	125	25	SN.. 1204..	APL-02	ALV-03-M8x19	AASN-3-0004	AAY-02	ACK-05	4015-M4x11	AAL-03-3
PSSNR/L 2525 M12C	●	●	25	25	150	32								
PSSNR/L 3232 P12C	●	●	32	32	170	40	SN.. 1506..	APL-04	ALV-04-M8x22	AASN-3-0023	AAY-03	ACK-09	AAV-05-M6x15	AAL-05-4
PSSNR/L 3232 P15C	●	○	32	32	170	40								
PSSNR/L 3232 P19C	●	●	32	32	170	40	SN.. 1906..	APL-05	ALV-05-M10x27	AASN-3-0005	AAY-04	ACK-09	AAV-05-M6x15	AAL-05-4
PSSNR/L 4040 S19C	●	●	40	40	250	50								
PSSNR/L 4040 S25C	●	●	40	40	250	50	SN.. 2509..	APL-06	ALV-06-M12x36	AASN-3-0020	AAY-05	ACK-04	AKV-16-M6x16	AAL-07-5

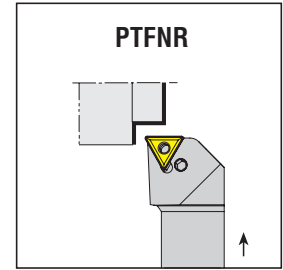
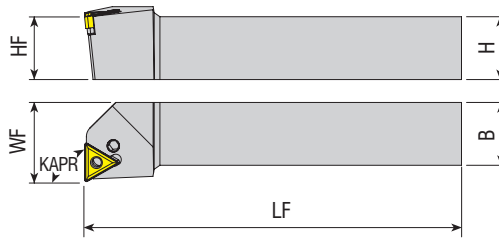

Takım Kodu Ordering Code Bestell-Bezeichnung	Stok Stock Lager		Takım Ölçüleri (mm) Dimension (mm) Abmessung (mm)				Kesici Uç Insert Wendeschneidplatte	Yedek Parçaları / Spare Parts / Ersatzteile						
	R	L	HF=H	B	LF	WF		Levyeye Lever Kniehebel	Levyeye Vidası Lever Screw Kniehebelschraube	Altılık Shim Unterlage	Altılık Yay Shim Spring Feder für Unterlage	Baskı Parçası Wedge Clamp Spannpratze	Baskı Vidası Clamp Screw Klemmschraube	Anahtar Allen Key Innerschraubschlüssel
	●	○												
PTFNR/L 1616 H16	●	●	16	16	100	20	TN.. 1604..	APL-01	ALV-02-M6x17	AATN-3-0025	AAY-01	-	-	AAL-02-2.5
PTFNR/L 2020 K16	●	●	20	20	125	25								
PTFNR/L 2525 M16	●	●	25	25	150	32	TN.. 2204...	APL-02	ALV-03-M8x19	AATN-3-0015	AAY-02	ACK-05	4015-M4x11	AAL-03-3
PTFNR/L 3232 P16	●	●	32	32	170	40								
PTFNR/L 2525 M22C	●	●	25	25	150	32	TN.. 2706..	APL-04	ALV-04-M8x22	AATN-3-0027	AAY-03	ACK-09	AAV-05-M6x15	AAL-03-3
PTFNR/L 3232 P22C	●	●	32	32	170	40								
PTFNR/L 4040 S27C	○	○	40	40	250	50								

R: Sağ / Right / Rechts L: Sol / Left / Links

● Stokta / In Stock / Auf Lager ○ Stokta Yok / Non Stock Item / Kein Lagerartikel, Lieferzeit auf Anfrage

Sipariş Örneği/Ordering Example/Bestellbeispiel

1 ad./pcs./stück PSSNR 1616 H09

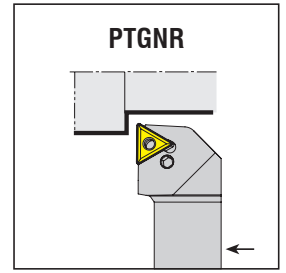
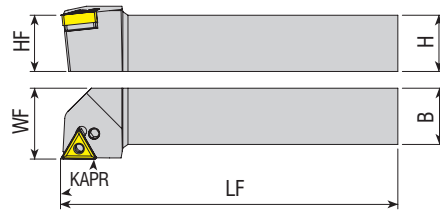

Takım Kodu Ordering Code Bestell-Bezeichnung	Stok Stock Lager		Takım Ölçüleri (mm) Dimension (mm) Abmessung (mm)				Kesici Uç Insert Wendeschneidplatte	Yedek Parçaları / Spare Parts / Ersatzteile						
	R	L	HF=H	B	LF	WF		Levye Lever Kniehebel	Levye Vidası Lever Screw Kniehebelschraube	Altlık Shim Unterlage	Altlık Yay Shim Spring Feder für Unterlage	Baskı Parçası Wedge Clamp Spannpratze	Baskı Vidası Clamp Screw Klemmschraube	Anahtar Allen Key Innensechskantschlüssel
	○	○												
PTGNR/L 1010 E11	○	○	10	10	70	12	TN.. 1103..	APL-11	ALV-10-M5x10	-	-	-	-	AAL-13-2.5
PTGNR/L1212 F11	○	○	12	12	80	16								
PTGNR/L1616 H11	○	○	16	16	100	20								
PTGNR/L1616 H16	●	●	16	16	100	20	TN.. 1604..	APL-01	ALV-02-M6x17	AATN-3-0025	AAY-01	-	-	AAL-02-2.5
PTGNR/L2020 K16	●	●	20	20	125	25								
PTGNR/L2525 M16	●	●	25	25	150	32								
PTGNR/L3232 P16	○	○	32	32	170	40	TN.. 2204...	APL-02	ALV-03-M8x19	AATN-3-0015	AAY-02	ACK-05	4015-M4x11	AAL-03-3
PTGNR/L2525 M22C	●	●	25	25	150	32								
PTGNR/L3232 P22C	●	●	32	32	170	40								
PTGNR/L4040 S27C	○	○	40	40	250	50	TN.. 2706..	APL-04	ALV-04-M8x22	AATN-3-0027	AAY-03	ACK-09	AAV-05-M6x15	AAL-03-3

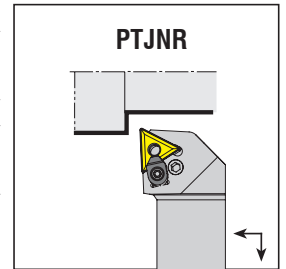
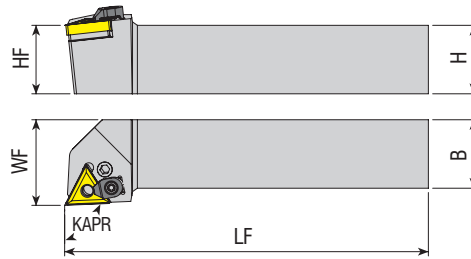

Takım Kodu Ordering Code Bestell-Bezeichnung	Stok Stock Lager		Takım Ölçüleri (mm) Dimension (mm) Abmessung (mm)				Kesici Uç Insert Wendeschneidplatte	Yedek Parçaları / Spare Parts / Ersatzteile						
	R	L	HF=H	B	LF	WF		Levye Lever Kniehebel	Levye Vidası Lever Screw Kniehebelschraube	Altlık Shim Unterlage	Altlık Yay Shim Spring Feder für Unterlage	Baskı Parçası Wedge Clamp Spannpratze	Baskı Vidası Clamp Screw Klemmschraube	Anahtar Allen Key Innensechskantschlüssel
	○	○												
PTJNR/L 1010 E11	○	○	10	10	70	12	TN.. 1103..	APL-11	ALV-10-M5x10	-	-	-	-	AAL-13-2.5
PTJNR/L 1212 F11	○	○	12	12	80	16								
PTJNR/L 1616 H11	○	○	16	16	100	20								
PTJNR/L 1616 H16	●	●	16	16	100	20	TN.. 1604..	APL-01	ALV-02-M6x17	AATN-3-0025	AAY-01	-	-	AAL-02-2.5
PTJNR/L 2020 K16	●	●	20	20	125	25								
PTJNR/L 2525 M16	●	●	25	25	150	32								
PTJNR/L 3232 P16	●	●	32	32	170	40	TN.. 2204...	APL-02	ALV-03-M8x19	AATN-3-0015	AAY-02	ACK-05	4015-M4x11	AAL-03-3
PTJNR/L 2525 M22C	●	●	25	25	150	32								
PTJNR/L 3232 P22C	●	●	32	32	170	40								
PTJNR/L 4040 S27C	○	○	40	40	250	50	TN.. 2706..	APL-04	ALV-04-M8x24	AATN-3-0027	AAY-03	ACK-09	AAV-05-M6x15	AAL-03-3

R: Sağ / Right / Rechts L: Sol / Left / Links

● Stokta / In Stock / Auf Lager ○ Stokta Yok / Non Stock Item / Kein Lagerartikel, Lieferzeit auf Anfrage

Sipariş Örneği/Ordering Example/Bestellbeispiel

1 ad./pcs./stück PTGNR 1010 E11

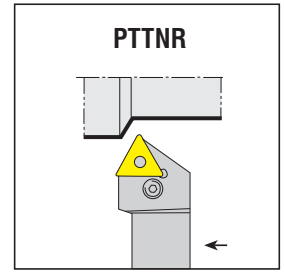
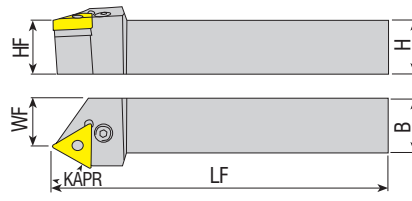

Takım Kodu Ordering Code Bestell-Bezeichnung	Stok Stock Lager		Takım Ölçüleri (mm) Dimension (mm) Abmessung (mm)				Kesici Uç Insert Wendeschneidplatte	Yedek Parçaları / Spare Parts / Ersatzteile						
	R	L	HF=H	B	LF	WF		Levye Lever Kniehebel	Levye Vidası Lever Screw Kniehebelschraube	Altılık Shim Unterlage	Altılık Yay Shim Spring Feder für Unterlage	Baskı Parçası Wedge Clamp Spannpratze	Baskı Vidası Clamp Screw Klemmschraube	Anahtar Allen Key Innerschrautenschlüssel
	●	○												
PTTNR/L 1616 H16	●	●	16	16	100	13	TN.. 1604..	APL-01	ALV-02-M6x17	AATN-3-0025	AAV-01	-	-	AAL-02-2.5
PTTNR/L 2020 K16	●	●	20	20	125	17								
PTTNR/L 2525 M16	●	●	25	25	150	21.5								
PTTNR/L 3232 P16	●	●	32	32	170	31								
PTTNR/L 2525 M22C	●	●	25	25	150	20.5	TN.. 2204...	APL-02	ALV-03-M8x19	AATN-3-0015	AAV-02	ACK-05	4015-M4x11	AAL-03-3
PTTNR/L 3232 P22C	●	●	32	32	170	29								

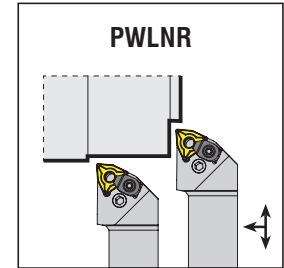
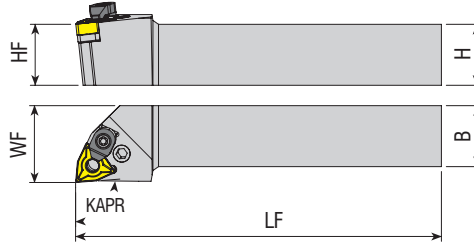

Takım Kodu Ordering Code Bestell-Bezeichnung	Stok Stock Lager		Takım Ölçüleri (mm) Dimension (mm) Abmessung (mm)				Kesici Uç Insert Wendeschneidplatte	Yedek Parçaları / Spare Parts / Ersatzteile						
	R	L	HF=H	B	LF	WF		Levye Lever Kniehebel	Levye Vidası Lever Screw Kniehebelschraube	Altılık Shim Unterlage	Altılık Yay Shim Spring Feder für Unterlage	Baskı Parçası Wedge Clamp Spannpratze	Baskı Vidası Clamp Screw Klemmschraube	Anahtar Allen Key Innerschrautenschlüssel
	●	○												
PWLNR/L 1616 H06	●	●	16	16	100	20	WN.. 0604..	APL-01	ALV-02-M6x17	AAWN-SW317	AAV-01	-	-	AAL-02-2.5
PWLNR/L 2020 K06	●	●	20	20	125	25								
PWLNR/L 2525 M06	●	●	25	25	150	32								
PWLNR/L 3232 P06	○	○	32	32	170	40								
PWLNR/L 1616 H08	●	●	16	16	100	20	WN.. 0804..	APL-02	ALV-03-M8x19	AAWN-3-0001	AAV-02	ACK-05	4015-M4x11	AAL-03-3
PWLNR/L 2020 K08C	●	●	20	20	125	25								
PWLNR/L 2525 M08C	●	●	25	25	150	32								
PWLNR/L 3232 P08C	●	●	32	32	170	40								

R: Sağ / Right / Rechts L: Sol / Left / Links

● Stokta / In Stock / Auf Lager ○ Stokta Yok / Non Stock Item / Kein Lagerartikel, Lieferzeit auf Anfrage

Sipariş Örneği / Ordering Example / Bestellbeispiel

1 ad./pcs./stück PTTNR 1616 H16



KAPR=95°

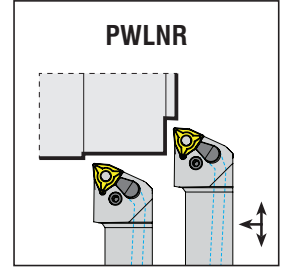
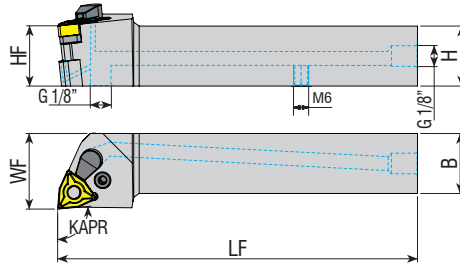

Takım Kodu Ordering Code Bestell-Bezeichnung	Stok Stock Lager		Takım Ölçüleri (mm) Dimension (mm) Abmessung (mm)				Kesici Uç Insert Wendeschneidplatte	Yedek Parçaları / Spare Parts / Ersatzteile									
	R	L	HF=H	B	LF	WF		Levyeye Lever Kniehebel	Levyeye Vidası Lever Screw Kniehebelschraube	Altılık Shim Unterlage	Altılık Yay Shim Spring Feder für Unterlage	Oring Ring Feder	Sızdırmaz Vida Threaded Pin Gewindestift	Nozul Spannpratze Spannpratze C0X Innenschleifschlüssel	Anahtar Allen Key		
PWLNR/L 2020 K08-H	●	●	20	20	125	25	WN.. 0804..	APL-02	ALV-03-M8x19	AAWN-3-0001	AAY-02	AXR-01 AOR-01	2705-G1/8x5.5	AN-01	AAL-03-3		
PWLNR/L 2525 M08-H	●	●	25	25	150	32											

VDI tutucu ile uyumludur. / Compatible with VDI holders. / Kompatibel mit VDI Werkzeughalter.

KAPR=93°

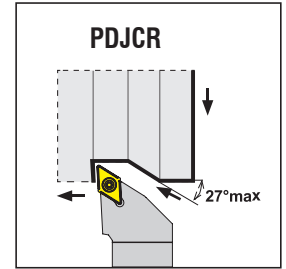
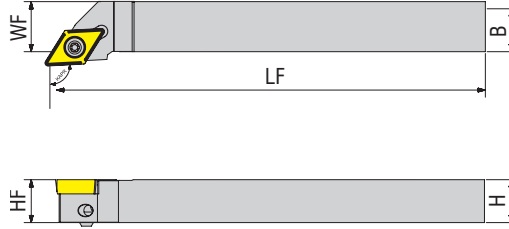

Takım Kodu Ordering Code Bestell-Bezeichnung	Stok Stock Lager		Takım Ölçüleri (mm) Dimension (mm) Abmessung (mm)				Kesici Uç Insert Wendeschneidplatte	Yedek Parçaları / Spare Parts / Ersatzteile									
	R	L	HF=H	B	LF	WF		Levyeye Lever Kniehebel	Levyeye Vidası Lever Screw Kniehebelschraube	Altılık Shim Unterlage	Altılık Yay Shim Spring Feder für Unterlage	Baskı Parçası Wedge Clamp Spannpratze	Baskı Vidası Clamp Screw Klemmschraube	Anahtar Allen Key Innenschleifschlüssel			
PDJCR/L 1010 K11-S	●	○	10	10	125	10	DC.. 11T3..	APL-14 APL-15	2802-M4x8	-	-	-	-	-	AAL-01-02		
PDJCR/L 1212 K11-S	●	○	12	12	125	12											
PDJCR/L 1616 K11-S	●	○	16	16	125	16											

R: Sağ / Right / Rechts L: Sol / Left / Links

● Stokta / In Stock / Auf Lager ○ Stokta Yok / Non Stock Item / Kein Lagerartikel, Lieferzeit auf Anfrage
ISO Ucuna Uygunudur. / Compatible with ISO Insert. / Под пластину ISO Wendeplatten.

Sipariş Örneği/Ordering Example/Bestellbeispiel

1 ad./pcs./stück PWLNR 2020 K08-H

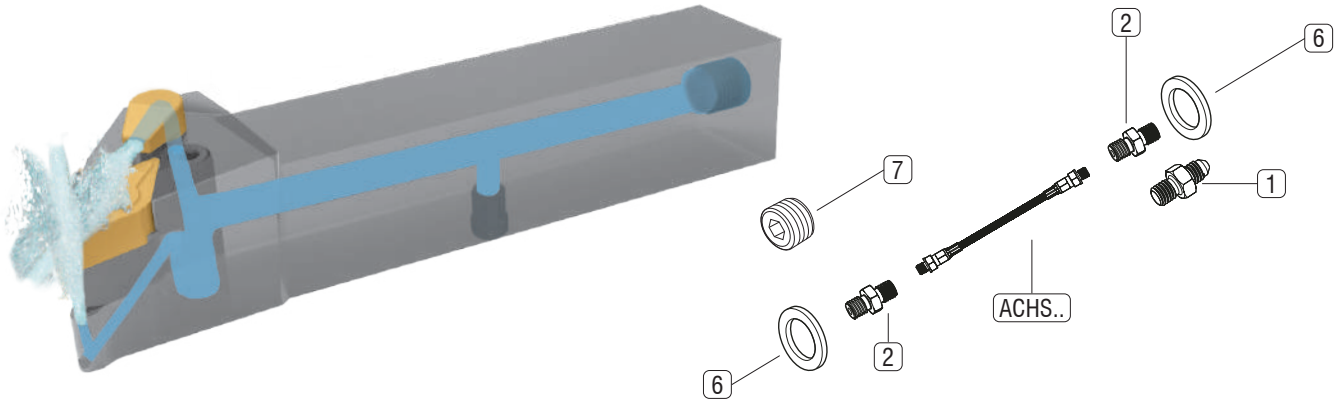

Not: İçten soğutmalı tüm torna katerlerinde kullanılabilir 3 tip soğutma hortum setleri tasarlanmıştır. Takımların kullanılmasından önce, kullanılmayan bağlantıların set içindeki vida ile kapatılarak sızdırmazlığın sağlanmasına dikkat edilmelidir. Torna katerlerine yönelik soğutma hortum setleri, ACHS... 10 bar ile maksimum 150 bar basınç aralığında kullanılabilir.

Note: 3 types of cooling hose sets are designed that can be used in all internally cooled lathes. Before using the tools, care should be taken to ensure that the unused connections are closed with the screw in the set and that sealing is ensured. Cooling hose sets for lathe tools can be used in the pressure range of ACHS ... 10 bar to max 150 bar.

Notiz: Es wurden 3 Arten von Kühlschlauch-Sets entwickelt, die in allen intern gekühlten Drehmaschinen verwendet werden können. Vor der Verwendung der Werkzeuge sollte darauf geachtet werden, dass die nicht verwendeten Verbindungen mit der Schraube im Satz geschlossen werden und die Abdichtung gewährleistet ist. Kühlschlauchsätze für Drehmaschinen können im Druckbereich von ACHS ... 10 bar bis max. 150 bar eingesetzt werden.

Set İçindeki Parçalar Parts In The Set Teile im Set				Uzunluk / Length Code / Länge		
				Set Kodu: Set Code: Code Einstellen:	Set Kodu: Set Code: Code Einstellen:	Set Kodu: Set Code: Code Einstellen:
	Resim Picture Bild	Takım Kodu Set Code Code Einstellen	Ürün Açıklaması Product Description Artikelbeschreibung	ACHS-1-250	ACHS-2-250	ACHS-3-250
1		AMP-01	M10 Bağlantı Elemanı M10 Fastener M10 Verschluss	1x	-	-
2		AMP-02	G 1/8" Çift Bağlantı Elemanı G 1/8" Double Fastener G 1/8" Doppelverschluss	2x	1x	-
3		AMP-03	G 1/8" Açılı Bağlantısı G 1/8" Angle Connection G 1/8" Winkelverbindung	-	1x	2x
4		AMP-04	M10" Açılı Bağlantısı M10" Angle Connection M10" Winkelverbindung	-	1x	1x
5		AMP-05	G1/4"-G1/8" Kılcalma Parçası G1/4"-G1/8" Capillary Piece G1/4"-G1/8" Kapillarstück	-	1x	1x
6		AG-01	Bakır Conta Copper Gasket Kupferdichtung	2x	3x	4x
7		2705-G1/8-5.5	G1/8" Sızdırmaz Cıvata G1/8" Sealing Bolt G1/8" Dichtungsschraube	1x	1x	1x
8		AH-1-250	Hortum Hose Schlauch	1x	-	-
9		AH-2-250	Hortum Hose Schlauch	-	1x	-
10		AH-3-250	Hortum Hose Schlauch	-	-	1x



*konusulan
the spoken kalite...
quality...*

C-SİSTEM

C-SİSTEM DIŞ TORNA KATERLERİ
C-SYSTEM EXTERNAL TURNING TOOLHOLDERS
C-SYSTEM AUSSEN - DREHHALTER



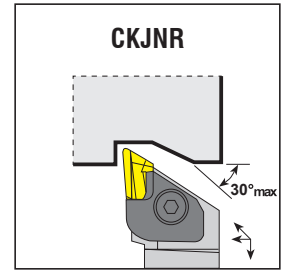
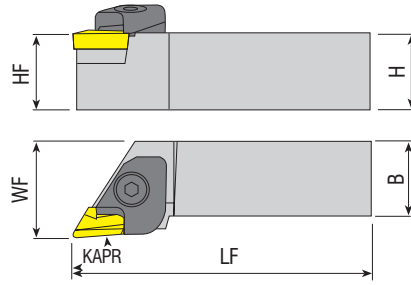

Takım Kodu
Ordering Code
Bestell-Bezeichnung

Stok Stock Lager		Takım Ölçüleri (mm) Dimension (mm) Abmessung (mm)			
R	L	HF=H	B	LF	WF
●	●	20	20	125	27.5
●	●	25	25	150	31.5
●	●	32	32	170	40
●	●	40	40	250	50

Kesici Uç Insert Wendeschnleidplatte
KNUX 1604..

Baskı Pabucu Wedge Clamp Spannpratze
ACK-01-R ACK-02-L

Pabuç Vidası Clamp Screw Klemmschraube
AKV-06-M6x20

Altık Shim Unterlage
AKS-16-R AKS-16-L

Altık Vidası Shim Screw Schraube für Unterlage
AAV-01-M3x10

Yay Spring Feder
AKY-02

Pul Stamp Ring
ABPL-01

Anahtar Allen Key Innensechskantschlüssel
AAL-05-4

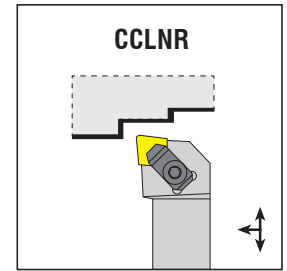
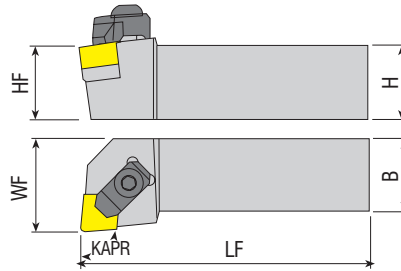

Takım Kodu
Ordering Code
Bestell-Bezeichnung

Stok Stock Lager		Takım Ölçüleri (mm) Dimension (mm) Abmessung (mm)			
R	L	HF=H	B	LF	WF
●	●	25	25	150	32
●	●	32	32	170	40
●	●	25	25	150	32

Kesici Uç Insert Wendeschnleidplatte
CN.. 1207..
CN.. 1607..

Baskı Pabucu Wedge Clamp Spannpratze
ACK-13

Pabuç Vidası Clamp Screw Klemmschraube
AKV-11-M8x29

Altık Shim Unterlage
AACN-3-0001 AACN-3-0002

Altık Vidası Shim Screw Schraube für Unterlage
AAV-02-M5x12 AAV-05-M6x15

Segman Ring Feder
ACS-01

Anahtar Allen Key Innensechskantschlüssel
AAL-05-4

R: Sağ / Right / Rechts L: Sol / Left / Links
● Stokta / In Stock / Auf Lager ○ Stokta Yok / Non Stock Item / Kein Lagerartikel, Lieferzeit auf Anfrage

Sipariş Örneği/Ordering Example/Bestellbeispiel
1 ad./pcs./stück CKJNR 2020 K16

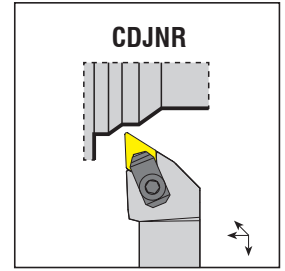
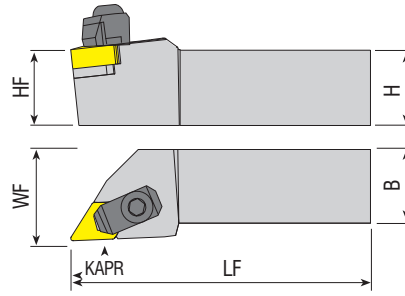

Takım Kodu Ordering Code Bestell-Bezeichnung	Stok Stock Lager		Takım Ölçüleri (mm) Dimension (mm) Abmessung (mm)				Kesici Uç Insert Wendeschneidplatte	Yedek Parçaları / Spare Parts / Ersatzteile					
	R	L	HF=H	B	LF	WF		Baskı Pabucu Wedge Clamp Spannpratze	Pabuç Vidası Clamp Screw Klemmschraube	Altlık Shim Unterlage	Altlık Vidası Shim Screw Schraube für Unterlage	Segman Ring Feder	Anahtar Allen Key Innensechskantschlüssel
CDJNR/L 2525 M1107C	●	●	25	25	150	32	DN.. 1107..	ACK-22	AKV-11-M8x29	AADN-2-0001	AAV-04-M5x12	ACS-01	AAL-05-4
CDJNR/L 2525 M1507C	●	●	25	25	150	32	DN.. 1507..	ACK-13	AKV-11-M8x29	AADN-3-0001	AAV-02-M5x12	ACS-01	AAL-05-4
CDJNR/L 3232 P1507C	●	●	32	32	170	40							

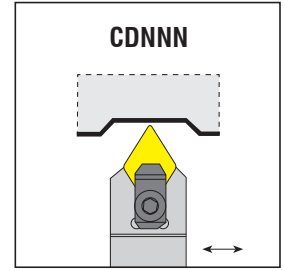
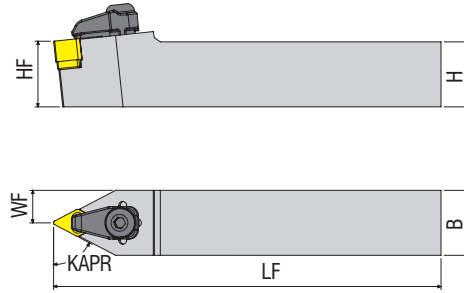

Takım Kodu Ordering Code Bestell-Bezeichnung	Stok Stock Lager		Takım Ölçüleri (mm) Dimension (mm) Abmessung (mm)				Kesici Uç Insert Wendeschneidplatte	Yedek Parçaları / Spare Parts / Ersatzteile					
	R	L	HF=H	B	LF	WF		Baskı Pabucu Wedge Clamp Spannpratze	Pabuç Vidası Clamp Screw Klemmschraube	Altlık Shim Unterlage	Altlık Vidası Shim Screw Schraube für Unterlage	Segman Ring Feder	Anahtar Allen Key Innensechskantschlüssel
CDNNN 2525 M1107C	●		25	25	150	12.5	DN.. 1107..	ACK-22	AKV-11-M8x29	AADN-2-0001	AAV-04-M5x12	ACS-01	AAL-05-4

R: Sağ / Right / Rechts L: Sol / Left / Links

● Stokta / In Stock / Auf Lager ○ Stokta Yok / Non Stock Item / Kein Lagerartikel, Lieferzeit auf Anfrage

Sipariş Örneği/Ordering Example/Bestellbeispiel

1 ad./pcs./stück CDJNR 2525 M1107C

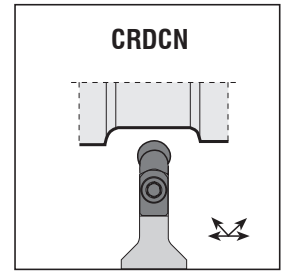
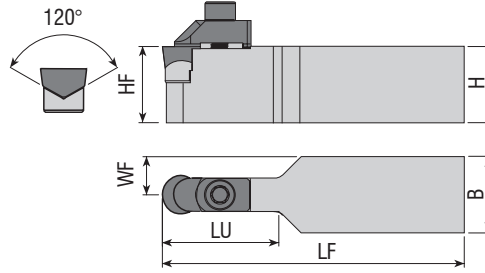

Takım Kodu Ordering Code Bestell-Bezeichnung	Stok Stock Lager	Takım Ölçüleri (mm) Dimension (mm) Abmessung (mm)					Kesici Uç Insert Wendeschneidplatte	Yedek Parçaları / Spare Parts / Ersatzteile				
		HF=H	B	LF	LU	WF		Baskı Pabucu Wedge Clamp Spannpratze	Pabuç Vidası Clamp Screw Klemmschraube	Altık Shim Unterlage	Altık Vidası Shim Screw Schraube für Unterlage	Anahtar Allen Key Innensechskantschlüssel
new CRDCN 2020 K06CV	●	20	20	125	19	10	RCGX 0606..	ACK-27	2525-M3X14	AARC-3-0001	3007-M2.2x5	AAL-02-2.5
CRDCN 2525 M06CV	●	25	25	150	19	12.5						
CRDCN 3225 P06CV	●	32	25	170	19	12.5						
CRDCN 4040 S06CV	●	40	40	250	19	20						
new CRDCN 2020 K09CV	●	20	20	125	29	10	RCGX 0907..	ACK-28	2504-M5X16	AARC-3-0002	3008-M2.5x6	AAL-05-4
CRDCN 2525 M09CV	●	25	25	150	29	12.5						
CRDCN 3225 P09CV	●	32	25	170	29	12.5						
CRDCN 4040 S09CV	●	40	40	250	29	20						
CRDCN 2525 M12CV	●	25	25	150	38	12.5	RCGX 1207..	ACK-29	2505-M6X20	AARC-3-0003	3008-M2.5x6	AAL-07-5
CRDCN 3225 P12CV	●	32	25	170	38	12.5						
CRDCN 4040 S12CV	●	40	40	250	38	20						

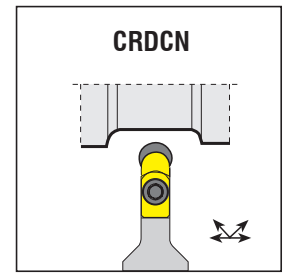
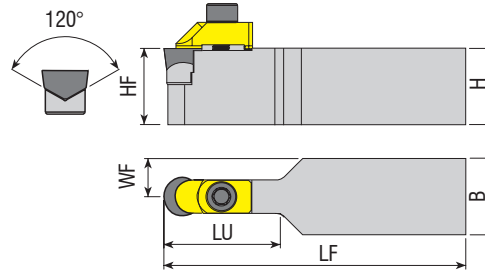

Takım Kodu Ordering Code Bestell-Bezeichnung	Stok Stock Lager	Takım Ölçüleri (mm) Dimension (mm) Abmessung (mm)					Kesici Uç Insert Wendeschneidplatte	Yedek Parçaları / Spare Parts / Ersatzteile				
		HF=H	B	LF	LU	WF		Baskı Pabucu Wedge Clamp Spannpratze	Pabuç Vidası Clamp Screw Klemmschraube	Altık Shim Unterlage	Altık Vidası Shim Screw Schraube für Unterlage	Anahtar Allen Key Innensechskantschlüssel
CRDCN 3232 P06CVK	●	32	32	170	19	16	RCGX 0606..	ACK-42	2525-M3x12	AARC-3-0005	2008-M2.5X12	AAL-02-2.5
CRDCN 4040 R06CVK	●	40	40	200	19	20						
CRDCN 3232 P09CVK	●	32	32	170	29	16	RCGX 0907..	ACK-43	2504-M5x14	AARC-3-0006	4015-M3.5x14	AAL-05-4
CRDCN 4040 R09CVK	●	40	40	200	29	20						
CRDCN 3232 P12CVK	●	32	32	170	38	16	RCGX 1207..	ACK-44	2505-M6x16	AARC-3-0007	1620-M5x18	AAL-07-5
CRDCN 4040 R12CVK	●	40	40	200	38	20						

R: Sağ / Right / Rechts L: Sol / Left / Links

● Stokta / In Stock / Auf Lager ○ Stokta Yok / Non Stock Item / Kein Lagerartikel, Lieferzeit auf Anfrage

Sipariş Örneği/Ordering Example/Bestellbeispiel

1 ad./pcs./stück CRDCN 2020 K06CV

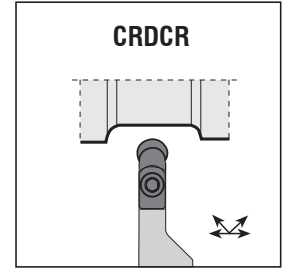
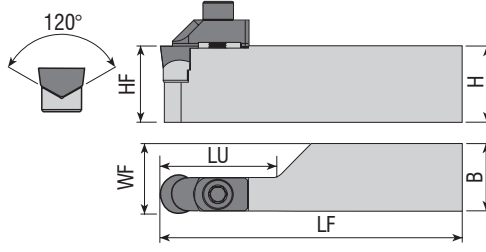

Takım Kodu Ordering Code Bestell-Bezeichnung	Stok Stock Lager		Takım Ölçüleri (mm) Dimension (mm) Abmessung (mm)				Kesici Uç Insert Wendeschnidplatte	Yedek Parçaları / Spare Parts / Ersatzteile					
	R	L	HF=H	B	LF	LU		WF	Baskı Pabucu Wedge Clamp Spannpratze	Pabuç Vidası Clamp Screw Klemmschraube	Altlık Shim Unterlage	Altlık Vidası Shim Screw Schraube für Unterlage	Anahtar Allen Key Innensechskantschlüssel
CRDCR/L 3225 P06CV	●	●	32	25	170	19.4	25.6	RCGX 0606..	ACK-27	2525-M3X14	AARC-3-0001	3007-M2.2X4.6	AAL-02-2.5
CRDCR/L 3225 P09CV	●	●	32	25	170	29	25.8	RCGX 0907..	ACK-28	2504-M5X16	AARC-3-0002	3008-M2.5x6	AAL-05-4
CRDCR/L 3225 P12CV	●	●	32	25	170	38.5	25.9	RCGX 1207..	ACK-29	2505-M6X20	AARC-3-0003	3008-M2.5x6	AAL-07-5

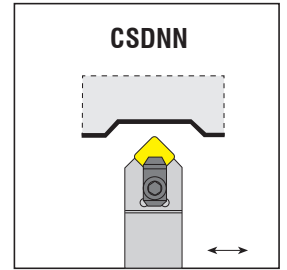
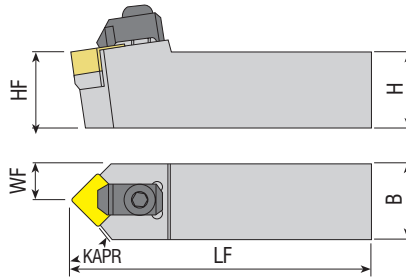

Takım Kodu Ordering Code Bestell-Bezeichnung	Stok Stock Lager		Takım Ölçüleri (mm) Dimension (mm) Abmessung (mm)				Kesici Uç Insert Wendeschnidplatte	Yedek Parçaları / Spare Parts / Ersatzteile					
	R	L	HF=H	B	LF	WF		Baskı Pabucu Wedge Clamp Spannpratze	Pabuç Vidası Clamp Screw Klemmschraube	Altlık Shim Unterlage	Altlık Vidası Shim Screw Schraube für Unterlage	Segman Ring Feder	Anahtar Allen Key Innensechskantschlüssel
CSDNN 2525 M1207C	●		25	25	150	12.5	SN.. 1207..	ACK-13	AKV-11-M8x29	AASN-3-0004	AAV-02-M5x12	ACS-01	AAL-05-4
CSDNN 3232 P1207C	●		32	32	170	16							

R: Sağ / Right / Rechts L: Sol / Left / Links

● Stokta / In Stock / Auf Lager ○ Stokta Yok / Non Stock Item / Kein Lagerartikel, Lieferzeit auf Anfrage

Sipariş Örneği/Ordering Example/Bestellbeispiel

1 ad./pcs./stück CRDCR 3225 P06CV

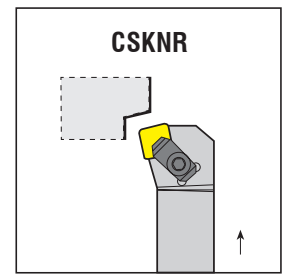
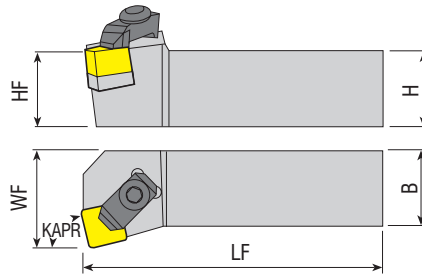

Takım Kodu Ordering Code Bestell-Bezeichnung	Stok Stock Lager		Takım Ölçüleri (mm) Dimension (mm) Abmessung (mm)				Kesici Uç Insert Wendeschneidplatte	Yedek Parçaları / Spare Parts / Ersatzteile					
	R	L	HF=H	B	LF	WF		Baskı Pabucu Wedge Clamp Spannpratze	Pabuç Vidası Clamp Screw Klemmschraube	Altlık Shim Unterlage	Altlık Vidası Shim Screw Schraube für Unterlage	Segman Ring Feder	Anahtar Allen Key Innensechskantschlüssel
	●	○											
CSKNR/L 2525 M1207C	●	○	25	25	150	32	SN.. 1207..	ACK-13	AKV-11-M8x29	AASN-3-0004	AAV-02-M5x12	ACS-01	AAL-05-4
CSKNR/L 3232 P1207C	●	○	32	32	170	40							

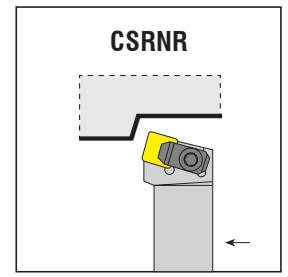
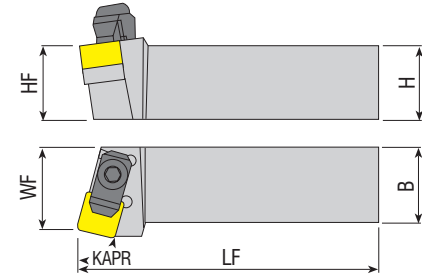
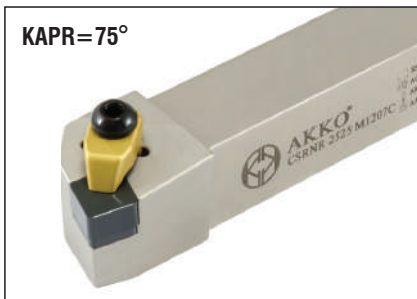

Takım Kodu Ordering Code Bestell-Bezeichnung	Stok Stock Lager		Takım Ölçüleri (mm) Dimension (mm) Abmessung (mm)				Kesici Uç Insert Wendeschneidplatte	Yedek Parçaları / Spare Parts / Ersatzteile					
	R	L	HF=H	B	LF	WF		Baskı Pabucu Wedge Clamp Spannpratze	Pabuç Vidası Clamp Screw Klemmschraube	Altlık Shim Unterlage	Altlık Vidası Shim Screw Schraube für Unterlage	Segman Ring Feder	Anahtar Allen Key Innensechskantschlüssel
	●	○											
CSRNR/L 2525 M1207C	●	○	25	25	150	32	SN.. 1207..	ACK-13	AKV-11-M8x29	AASN-3-0004	AAV-02-M5x12	ACS-01	AAL-05-4
CSRNR/L 3232 P1207C	●	○	32	32	170	40							

R: Sağ / Right / Rechts L: Sol / Left / Links
 ● Stokta / In Stock / Auf Lager ○ Stokta Yok / Non Stock Item / Kein Lagerartikel, Lieferzeit auf Anfrage

Sipariş Örneği/Ordering Example/Bestellbeispiel
 1 ad./pcs./stück CSKNR 2525 M1207C

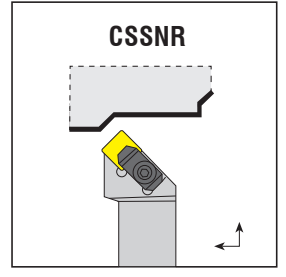
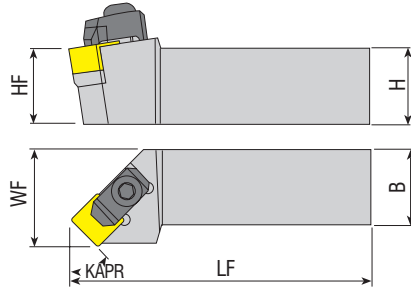

Takım Kodu
Ordering Code
Bestell-Bezeichnung

Stok Stock Lager	Takım Ölçüleri (mm) Dimension (mm) Abmessung (mm)					Kesici Uç Insert Wendeschnidplatte	Yedek Parçaları / Spare Parts / Ersatzteile						
	R	L	HF=H	B	LF		WF	Baskı Pabucu Wedge Clamp Spannpratze	Pabuç Vidası Clamp Screw Klemmschraube	Altlık Shim Unterlage	Altlık Vidası Shim Screw Schraube für Unterlage	Segman Ring Feder	Anahtar Allen Key Innensechskantschlüssel
CSSNR/L 2525 M1207C	●	●	25	25	150	32	SN.. 1207..	ACK-13	AKV-11-M8x29	AASN-3-0004	AAV-02-M5x12	ACS-01	AAL-05-4
CSSNR/L 3232 P1207C	●	●	32	32	170	40							

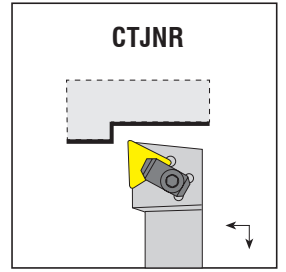
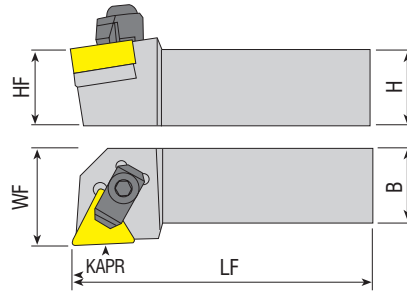
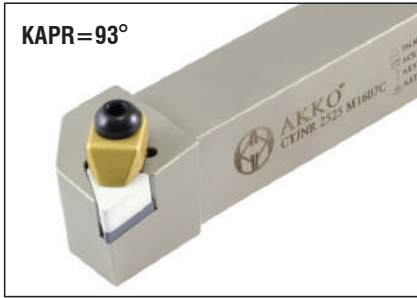

Takım Kodu
Ordering Code
Bestell-Bezeichnung

Stok Stock Lager	Takım Ölçüleri (mm) Dimension (mm) Abmessung (mm)					Kesici Uç Insert Wendeschnidplatte	Yedek Parçaları / Spare Parts / Ersatzteile						
	R	L	HF=H	B	LF		WF	Baskı Pabucu Wedge Clamp Spannpratze	Pabuç Vidası Clamp Screw Klemmschraube	Altlık Shim Unterlage	Altlık Vidası Shim Screw Schraube für Unterlage	Segman Ring Feder	Anahtar Allen Key Innensechskantschlüssel
CTJNR/L 2525 M1607C	●	●	25	25	150	32	TN.. 1607..	ACK-14	AKV-11-M8x29	AATN-2-0002	AAV-03-M5x12	ACS-01	AAL-05-4
CTJNR/L 3232 P1607C	○	○	32	32	170	40							

R: Sağ / Right / Rechts L: Sol / Left / Links

● Stokta / In Stock / Auf Lager ○ Stokta Yok / Non Stock Item / Kein Lagerartikel, Lieferzeit auf Anfrage

Sipariş Örneği/Ordering Example/Bestellbeispiel

1 ad./pcs./stück CSSNR 2525 M1207C

S-SİSTEM

S-SİSTEM DIŞ TORNA KATERLERİ
S-SYSTEM EXTERNAL TURNING TOOLHOLDERS
S-SYSTEM AUSSEN - DREHHALTER

*konusulan
the spoken kalite...
quality...*



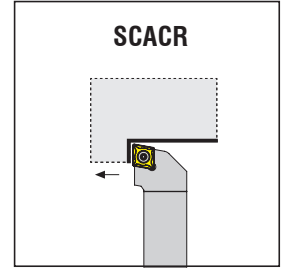
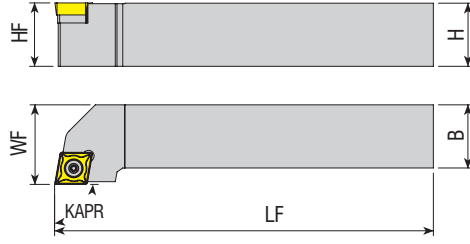
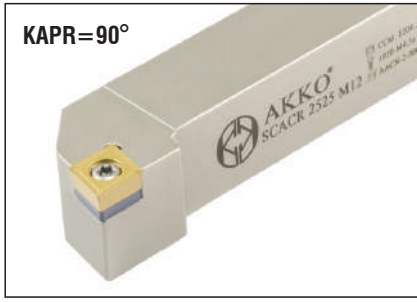

Takım Kodu Ordering Code Bestell-Bezeichnung	Stok Stock Lager		Takım Ölçüleri (mm) Dimension (mm) Abmessung (mm)				Kesici Uç Insert Wendeschneidplatte	Yedek Parçaları / Spare Parts / Ersatzteile			
	R	L	HF=H	B	LF	WF		Sıkma Vidası Screw Klemmschraube	Altlık Shim Unterlage	Altlık Vidası Shim Screw Schraube für Unterlage	Tork Anahtar Torx Key Torx-Schlüssel
SCACR/L 0808 E06	●	●	08	08	70	10	CC.. 0602..	4008-M2.5x6	-	-	82-T08
SCACR/L 1010 E06	●	●	10	10	70	12		4015-M3.5x11	-	-	
SCACR/L 1212 F09	●	●	12	12	80	16	CC.. 09T3..	4015-M3.5x14	AACN-2-0001	AAV-06-M3.5x11	80-T15
SCACR/L 1616 H09	●	●	16	16	100	20					
SCACR/L 2020 K09	●	●	20	20	125	25					
SCACR/L 2020 K12	●	●	20	20	125	25	CC.. 1204..	1020-M4.5x16	AACN-2-0003	AAV-07-M4.5x13	80-T20
SCACR/L 2525 M12	●	●	25	25	150	32					

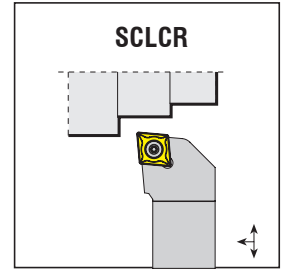
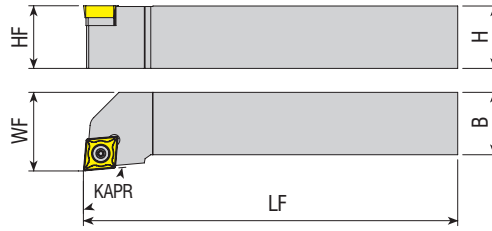
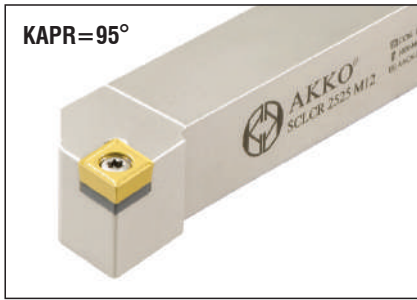

Takım Kodu Ordering Code Bestell-Bezeichnung	Stok Stock Lager		Takım Ölçüleri (mm) Dimension (mm) Abmessung (mm)				Kesici Uç Insert Wendeschneidplatte	Yedek Parçaları / Spare Parts / Ersatzteile			
	R	L	HF=H	B	LF	WF		Sıkma Vidası Screw Klemmschraube	Altlık Shim Unterlage	Altlık Vidası Shim Screw Schraube für Unterlage	Tork Anahtar Torx Key Torx-Schlüssel
SCLCR/L 0808 E06	●	●	08	08	70	10	CC.. 0602..	4008-M2.5x6	-	-	82-T08
SCLCR/L 1010 E06	●	○	10	10	70	12		4015-M3.5x9	-	-	
SCLCR/L 1212 F06	●	●	12	12	80	16	CC.. 09T3..	4015-M3.5x11	-	-	80-T15
SCLCR/L 1010 E09	●	●	10	10	70	12					
SCLCR/L 1212 F09	●	●	12	12	80	16					
new SCLCR/L 1212 M09	●	●	12	12	150	16	CC.. 1204..	4015-M3.5x14	AACN-2-0001	AAV-06-M3.5x11	80-T15
SCLCR/L 1616 H09	●	●	16	16	100	20					
SCLCR/L 2020 K09	●	●	20	20	125	25					
SCLCR/L 2525 M09	●	●	25	25	150	32	CC.. 1204..	1020-M5x11	AACN-2-0003	AAV-07-M4.5x13	80-T20
SCLCR/L 1616 H12	●	○	16	16	100	20		1020-M4.5x16			
SCLCR/L 2020 K12	●	●	20	20	125	25					
SCLCR/L 2525 M12	●	●	25	25	150	32					

R: Sağ / Right / Rechts L: Sol / Left / Links
● Stokta / In Stock / Auf Lager ○ Stokta Yok / Non Stock Item / Kein Lagerartikel, Lieferzeit auf Anfrage

Sipariş Örneği/Ordering Example/Bestellbeispiel
1 ad./pcs./stück SCACR 0808 E06

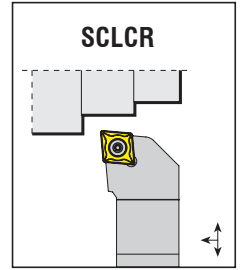
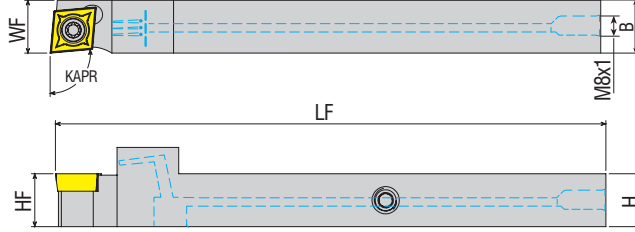
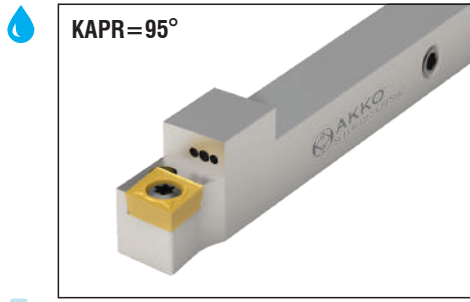

Takım Kodu Ordering Code Bestell-Bezeichnung	Stok Stock Lager		Takım Ölçüleri (mm) Dimension (mm) Abmessung (mm)				Kesici Uç Insert Wendeschneidplatte	Yedek Parçaları / Spare Parts / Ersatzteile					
	R	L	HF=H	B	LF	WF		Sıkma Vidası Screw Klemmschraube	Altılık Shim Unterlage	Altılık Vidası Shim Screw Schraube für Unterlage	Sızdırmaz Vidâ Threaded Pin Gewindestift	Anahtar Allen Key Innensechskantschlüssel	Tork Anahtar Torx Key Torx-Schlüssel
	●	○											
SCLCR/L 1212 K09-SHC	●	○	12	12	125	12	CC.. 09T3..	4015-M3.5x11	-	-	2703-M6X4	AAL-03-3	80-T15
SCLCR/L 1616 K09-SHC	●	○	16	16	125	16					2704-M8X1X5	AAL-05-4	

ISO Ucuna Uygundur. / Compatible with ISO Insert. / Kompatibel mit ISO Wendepfatten.

S-SİSTEM DIŞ TORNA KATERLERİ
S-SYSTEM EXTERNAL TURNING TOOLHOLDERS
S-SYSTEM AUSSEN - DREHHALTER

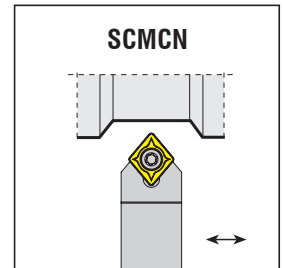
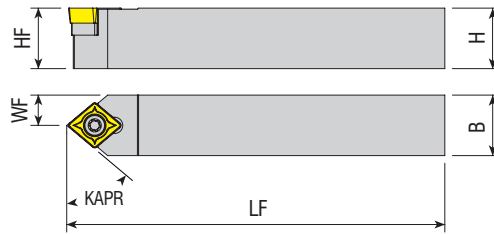
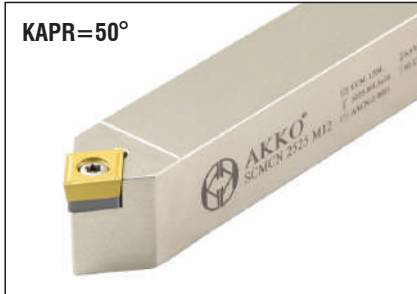

Takım Kodu Ordering Code Bestell-Bezeichnung	Stok Stock Lager		Takım Ölçüleri (mm) Dimension (mm) Abmessung (mm)				Kesici Uç Insert Wendeschneidplatte	Yedek Parçaları / Spare Parts / Ersatzteile				
	R	L	HF=H	B	LF	WF		Sıkma Vidası Screw Klemmschraube	Altılık Shim Unterlage	Altılık Vidası Shim Screw Schraube für Unterlage	Tork Anahtar Torx Key Torx-Schlüssel	
	●	○										
SCMCN 0808 E06	●		08	08	70	04	CC.. 0602..	4008-M2.5x6	-	-	82-T08	
SCMCN 1010 E06	●		10	10	70	05						
SCMCN 1212 F06	●		12	12	80	06						
SCMCN 1212 F09	●		12	12	80	06	CC.. 09T3..	4015-M3.5x11	-	-	80-T15	
SCMCN 1616 H09	●		16	16	100	08						4015-M3.5x14
SCMCN 2020 K12	●		20	20	125	10	CC.. 1204..	1020-M4.5x16	AACN-2-0003	AAV-07-M4.5x13	80-T20	
SCMCN 2525 M12	●		25	25	150	12.5						

R: Sağ / Right / Rechts L: Sol / Left / Links

● Stokta / In Stock / Auf Lager ○ Stokta Yok / Non Stock Item / Kein Lagerartikel, Lieferzeit auf Anfrage

Sipariş Örneği/Ordering Example/Bestellbeispiel

1 ad./pcs./stück SCLCR/L 1212 K09-SHC

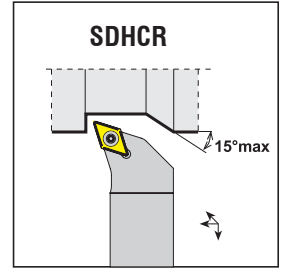
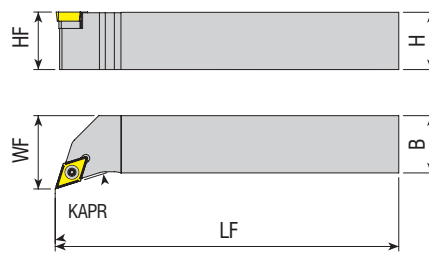
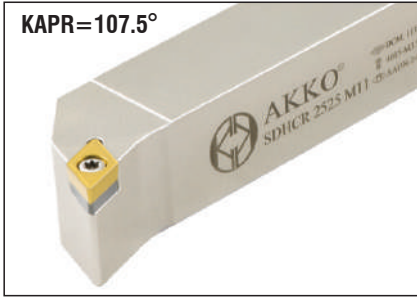

Takım Kodu Ordering Code Bestell-Bezeichnung	Stok Stock Lager		Takım Ölçüleri (mm) Dimension (mm) Abmessung (mm)				Kesici Uç Insert Wendeschneidplatte	Yedek Parçaları / Spare Parts / Ersatzteile				
	R	L	HF=H	B	LF	WF		Sıkma Vidası Screw Klemmschraube	Altlık Shim Unterlage	Altlık Vidası Shim Screw Schraube für Unterlage	Tork Anahtar Torx Key Torx-Schlüssel	
SDHCR/L 0808 E07	●	●	08	08	70	11	DC.. 0702..	4008-M2.5x6	-	-	82-T08	
SDHCR/L 1010 E07	●	●	10	10	70	12						
SDHCR/L 1212 F07	●	●	12	12	80	16						
SDHCR/L 1616 H07	●	●	16	16	100	20						
SDHCR/L 1616 H11	●	●	16	16	100	20	DC.. 11T3..	4015-M3.5x14	AADN-2-0001	AAV-06-M3.5x11	80-T15	
SDHCR/L 2020 K11	●	●	20	20	125	25						
SDHCR/L 2525 M11	●	●	25	25	150	32						
SDHCR/L 3232 P11	●	●	32	32	170	40						

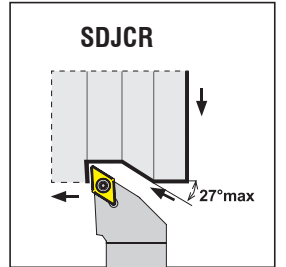
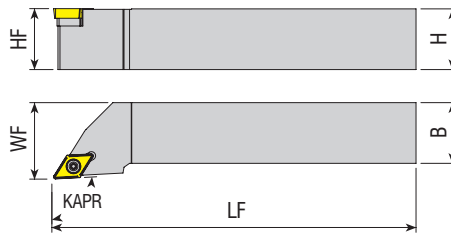
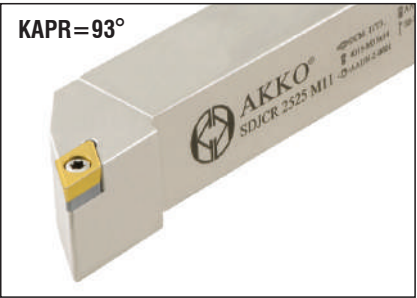

Takım Kodu Ordering Code Bestell-Bezeichnung	Stok Stock Lager		Takım Ölçüleri (mm) Dimension (mm) Abmessung (mm)				Kesici Uç Insert Wendeschneidplatte	Yedek Parçaları / Spare Parts / Ersatzteile				
	R	L	HF=H	B	LF	WF		Sıkma Vidası Screw Klemmschraube	Altlık Shim Unterlage	Altlık Vidası Shim Screw Schraube für Unterlage	Tork Anahtar Torx Key Torx-Schlüssel	
SDJCR/L 0808 E07	●	●	08	08	70	10	DC.. 0702..	4008-M2.5x6	-	-	82-T08	
SDJCR/L 1010 E07	●	●	10	10	70	12						
SDJCR/L 1212 F07	●	●	12	12	80	16						
SDJCR/L 1616 H07	●	●	16	16	100	20						
SDJCR/L 1212 F11	●	●	12	12	80	16	DC.. 11T3..	4015-M3.5x14	AADN-2-0001	AAV-06-M3.5x11	80-T15	
SDJCR/L 1616 H11	●	●	16	16	100	20						
SDJCR/L 2020 K11	●	●	20	20	125	25						
SDJCR/L 2525 M11	●	●	25	25	150	32						
SDJCR/L 3232 P11	●	●	32	32	170	40						

R: Sağ / Right / Rechts L: Sol / Left / Links

● Stokta / In Stock / Auf Lager ○ Stokta Yok / Non Stock Item / Kein Lagerartikel, Lieferzeit auf Anfrage

Sipariş Örneği/Ordering Example/Bestellbeispiel

1 ad./pcs./stück SDHCR 0808 E07

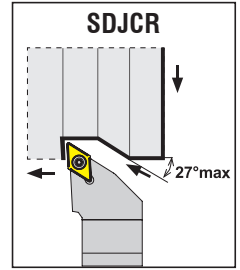
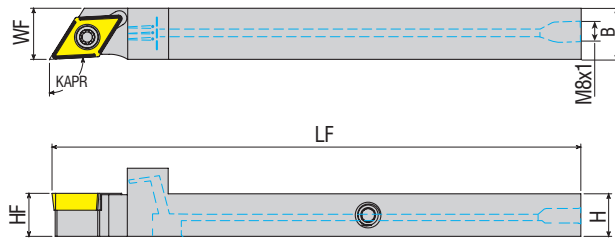
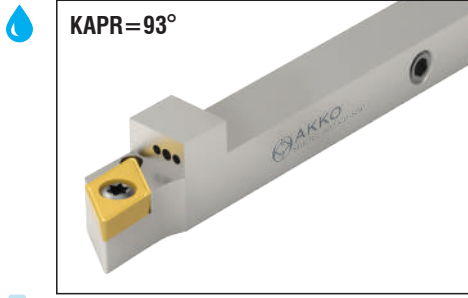

Takım Kodu Ordering Code Bestell-Bezeichnung	Stok Stock Lager		Takım Ölçüleri (mm) Dimension (mm) Abmessung (mm)				Kesici Uç Insert Wendeschneidplatte	Sıkma Vidası Screw Klemmschraube	Altık Shim Unterlage	Altık Vidası Shim Screw Schraube für Unterlage	Sızdırmaz Vida Threaded Pin Gewindestift	Anahtar Allen Key Innensechskantschlüssel	Tork Anahtar Torx Key Torx-Schlüssel
	R	L	HF=H	B	LF	WF							
SDJCR/L 0810 G07-SHC	●	○	8	10	90	10	DC.. 0702..	4008-M2.5x6					82-T08
SDJCR/L 1010 K07-SHC	●	○	10	10	125	10							
SDJCR/L 1012 K11-SHC	●	○	10	12	125	12	DC.. 11T3..	4015-M3.5x14	-	-	2703-M6X4	AAL-03-3	80-T15
SDJCR/L 1212 K11-SHC	●	○	12	12	125	12					2704-M8X1X5	AAL-05-4	
SDJCR/L 1616 K11-SHC	●	○	16	16	125	16							

ISO Ucuna Uygundur. / Compatible with ISO Insert. / Kompatibel mit ISO Wendepfatten.

S-SİSTEM DIŞ TORNA KATERLERİ
S-SYSTEM EXTERNAL TURNING TOOLHOLDERS
S-SYSTEM AUSSEN - DREHHALTER

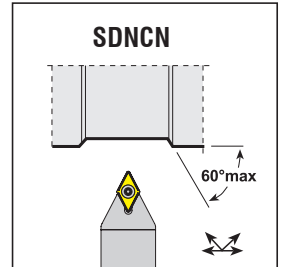
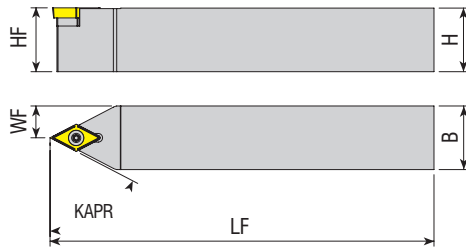
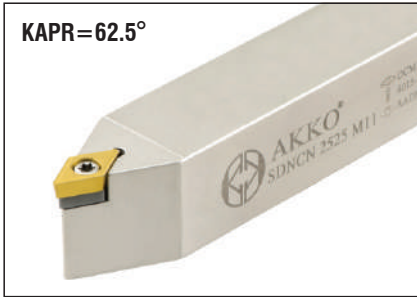

Takım Kodu Ordering Code Bestell-Bezeichnung	Stok Stock Lager		Takım Ölçüleri (mm) Dimension (mm) Abmessung (mm)				Kesici Uç Insert Wendeschneidplatte	Sıkma Vidası Screw Klemmschraube	Altık Shim Unterlage	Altık Vidası Shim Screw Schraube für Unterlage	Tork Anahtar Torx Key Torx-Schlüssel
	R	L	HF=H	B	LF	WF					
SDNCN 0808 E07	●		08	08	70	4	DC.. 0702..	4008-M2.5x6	-	-	82-T08
SDNCN 1010 E07	●		10	10	70	5					
SDNCN 1212 F07	●		12	12	80	6					
SDNCN 1616 H07	●		16	16	100	8					
SDNCN 1616 H11	●		16	16	100	8	DC.. 11T3..	4015-M3.5x14	AADN-2-0001	AAV-06-M3.5x11	80-T15
SDNCN 2020 K11	●		20	20	125	10					
SDNCN 2525 M11	●		25	25	150	12.5					
SDNCN 3232 P11	●		32	32	170	16					

R: Sağ / Right / Rechts L: Sol / Left / Links

● Stokta / In Stock / Auf Lager ○ Stokta Yok / Non Stock Item / Kein Lagerartikel, Lieferzeit auf Anfrage

Sipariş Örneği/Ordering Example/Bestellbeispiel
1 ad./pcs./stück SDJCR/L 0810 G07-SHC

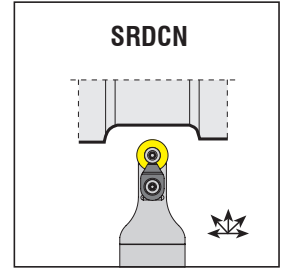
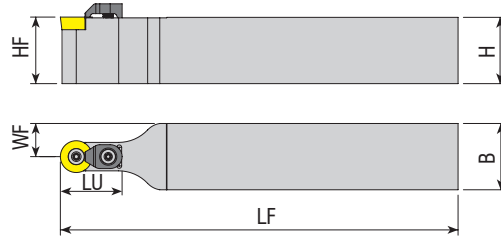

Takım Kodu Ordering Code Bestell-Bezeichnung	Stok Stock Lager	Takım Ölçüleri (mm) Dimension (mm) Abmessung (mm)					Kesici Uç Insert Wendeschneidplatte	Yedek Parçaları / Spare Parts / Ersatzteile							
		HF=H	B	LF	LU	WF		Sıkma Vidası Screw Klemmschraube	Altlık Shim Unterlage	Altlık Vidası Shim Screw Schraube für Unterlage	Baskı Parçası Wedge Clamp Spannpratze	Baskı Vidası Clamp Screw Klemmschraube	Tork Anahtar Torx Key Torx-Schlüssel		
SRDCN 1616 H06	●	16	16	100	15	8	RC.. 0602..	3008-M2.5x6	-	-	-	-	-	-	82-T08
SRDCN 2020 K06	●	20	20	125	17	10									
SRDCN 2525 M06	●	25	25	150	17	12.5	RC.. 0803..	3008-M3x8	-	-	ACK-15	4015-M3.5x11	-	-	-
SRDCN 1616 H08C	●	16	16	100	15	8									
SRDCN 2020 K08C	●	20	20	125	20	10	RC.. 10T3..	4015-M3.5x11	-	-	-	-	-	-	-
SRDCN 2525 M08C	●	25	25	150	20	12.5									
SRDCN 1616 H10C	●	16	16	100	20	8	RC.. 1204..	4015-M3.5x11	-	-	ACK-05	4015-M4x11	-	-	-
SRDCN 2020 K10C	●	20	20	125	20	10									
SRDCN 2525 M10C	●	25	25	150	20	12.5	RC.. 1605..	1020-M5x11	-	-	-	-	-	-	-
SRDCN 3232 P10C	●	32	32	170	20	16									
SRDCN 2020 K12C	●	20	20	125	22	10	RC.. 2006..	1420-M6x16	-	-	ACK-09	AAV-05-M6x15	-	-	80-T15
SRDCN 2525 M12C	●	25	25	150	22	12.5									
SRDCN 3232 P12C	●	32	32	170	22	16	RC.. 2507..	1520-M6x16	-	-	-	-	-	-	80-T20
SRDCN 2525 M16C	●	25	25	150	32	12.5									
SRDCN 3232 P16C	●	32	32	170	35	16	RC.. 3209..	1904-M8x1x20	-	-	-	-	-	-	-
SRDCN 2525 M20C	●	25	25	150	32	12.5									
SRDCN 3232 P20C	●	32	32	170	40	16									
SRDCN 3232 P25C	●	32	32	170	40	16									
SRDCN 3232 P32C	●	32	32	170	45	16									

R: Sağ / Right / Rechts L: Sol / Left / Links

● Stokta / In Stock / Auf Lager ○ Stokta Yok / Non Stock Item / Kein Lagerartikel, Lieferzeit auf Anfrage

Sipariş Örneği/Ordering Example/Bestellbeispiel

1 ad./pcs./stück SRDCN 1616 H06



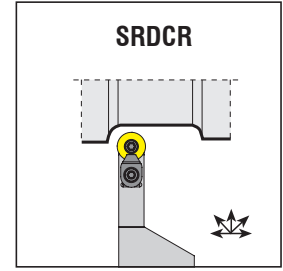
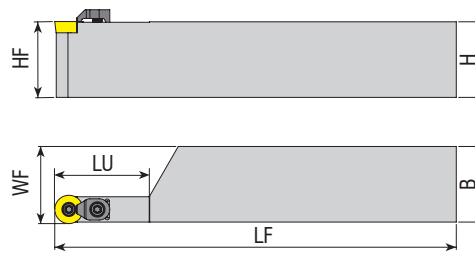

Takım Kodu
Ordering Code
Bestell-Bezeichnung

Stok Stock Lager	Takım Ölçüleri (mm) Dimension (mm) Abmessung (mm)						Kesici Uç Insert Wendeschneidplatte	Yedek Parçaları / Spare Parts / Ersatzteile						
	R	L	HF=H	B	LF	LU		WF	Sıkma Vidası Screw Klemmschraube	Altlık Shim Unterlage	Altlık Vidası Shim Screw Schraube für Unterlage	Baskı Parçası Wedge Clamp Spannpratze	Baskı Vidası Clamp Screw Klemmschraube	Tork Anahtar Torx Key Torx-Schlüssel
SRDCR/L 3232 T06	●	●	32	32	300	20	32.35	RC.. 0602..	3008-M2.5x6	-	-	-	-	82-T08
SRDCR/L 3232 P12C	●	●	32	32	170	40	32.65	RC.. 1204..	4015-M3.5x11	-	-	ACK-05	4015-M4x11	80-T15
new SRDCR/L 3232 P16C	●	○	32	32	170	40	32.85	RC.. 1605..	1020-M5x11	-	-	-	-	80-T20

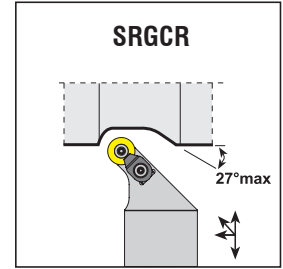
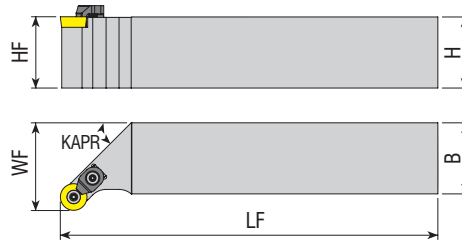

Takım Kodu
Ordering Code
Bestell-Bezeichnung

Stok Stock Lager	Takım Ölçüleri (mm) Dimension (mm) Abmessung (mm)						Kesici Uç Insert Wendeschneidplatte	Yedek Parçaları / Spare Parts / Ersatzteile						
	R	L	HF=H	B	LF	WF		Sıkma Vidası Screw Klemmschraube	Altlık Shim Unterlage	Altlık Vidası Shim Screw Schraube für Unterlage	Baskı Parçası Wedge Clamp Spannpratze	Baskı Vidası Clamp Screw Klemmschraube	Tork Anahtar Torx Key Torx-Schlüssel	
SRGCR/L 1616 H06	●	●	16	16	100	20	RC.. 0602..	3008-M2.5x6	-	-	-	-	82-T08	
SRGCR/L 2020 K06	●	●	20	20	125	25								
SRGCR/L 1616 H08C	●	●	16	16	100	20	RC.. 0803..	3008-M3x8	-	-	-	-	82-T08	
SRGCR/L 2020 K08C	●	●	20	20	125	25								
SRGCR/L 2525 M08C	●	●	25	25	150	32	RC.. 10T3..	4015-M3.5x11	-	-	ACK-15	4015-M3.5x11	80-T15	
SRGCR/L 1616 H10C	●	●	16	16	100	20								
SRGCR/L 2020 K10C	●	●	20	20	125	25								
SRGCR/L 2525 M10C	●	●	25	25	150	32								
SRGCR/L 3232 P10C	●	●	32	32	170	40	RC.. 1204..	4015-M3.5x11	-	-	ACK-05	4015-M4x11	80-T15	
SRGCR/L 2020 K12C	●	●	20	20	125	25								
SRGCR/L 2525 M12C	●	●	25	25	150	32								
SRGCR/L 3232 P12C	●	●	32	32	170	40								

R: Sağ / Right / Rechts L: Sol / Left / Links

● Stokta / In Stock / Auf Lager ○ Stokta Yok / Non Stock Item / Kein Lagerartikel, Lieferzeit auf Anfrage

Sipariş Örneği/Ordering Example/Bestellbeispiel
1 ad./pcs./stück SRDCR 3232 T06

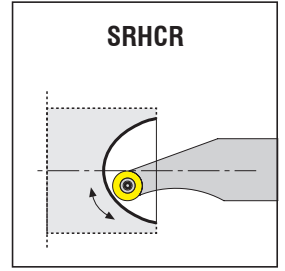
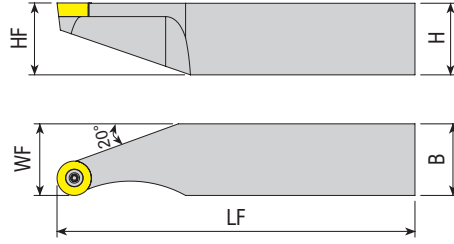

Takım Kodu
Ordering Code
Bestell-Bezeichnung

Stok Stock Lager	Takım Ölçüleri (mm) Dimension (mm) Abmessung (mm)						Kesici Uç Insert Wendeschneidplatte	Yedek Parçaları / Spare Parts / Ersatzteile				
	R	L	HF=H	B	LF	WF		MIN R	Sıkma Vidası Screw Klemmschraube	Altlık Shim Unterlage	Altlık Vidası Shim Screw Schraube für Unterlage	Tork Anahtar Torx Key Torx-Schlüssel
SRHCR/L 2525 K06	●	○	25	25	125	25	32.5	RC.. 0602..	3008-M2.5x6	-	-	82-T08
SRHCR/L 2525 K08	●	●	25	25	125	25	32.5	RC.. 0803..	3008-M3x8	-	-	82-T08
SRHCR/L 2525 K10	●	●	25	25	125	25	36	RC.. 10T3..	4015-M3.5x11	-	-	80-T15
SRHCR/L 2525 K12	●	●	25	25	125	25	40	RC.. 1204..	-	-	80-T15	
SRHCR/L 2525 K16	●	●	25	25	125	25	47.5	RC.. 1606..	1020-M5x11	-	-	80-T20

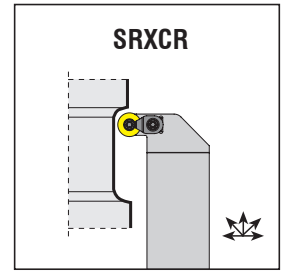
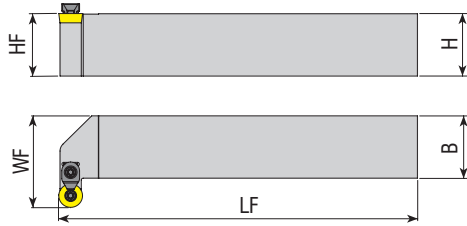

Takım Kodu
Ordering Code
Bestell-Bezeichnung

Stok Stock Lager	Takım Ölçüleri (mm) Dimension (mm) Abmessung (mm)						Kesici Uç Insert Wendeschneidplatte	Sıkma Vidası Screw Klemmschraube	Altlık Shim Unterlage	Altlık Vidası Shim Screw Schraube für Unterlage	Baskı Parçası Wedge Clamp Spannpratze	Baskı Vidası Clamp Screw Klemmschraube	Tork Anahtar Torx Key Torx-Schlüssel
	R	L	HF=H	B	LF	WF					ACK-15	ACK-05	
SRXCR/L 3232 X08C	●	●	32	32	220	47	RC.. 0803..	3008-M3x8	-	-	ACK-15	4015-M3.5x11	82-T08
SRXCR/L 3232 X10C	●	●	32	32	220	47	RC.. 10T3..	4015-M3.5x11	-	-	ACK-05	4015-M4x11	80-T15
SRXCR/L 3232 X12C	●	●	32	32	220	47	RC.. 1204..	-	-	-	-	-	80-T15

R: Sağ / Right / Rechts L: Sol / Left / Links

● Stokta / In Stock / Auf Lager ○ Stokta Yok / Non Stock Item / Kein Lagerartikel, Lieferzeit auf Anfrage

Sipariş Örneği/Ordering Example/Bestellbeispiel

1 ad./pcs./stück SRHCR 2525 K06

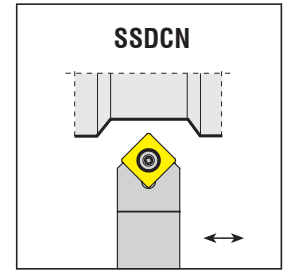
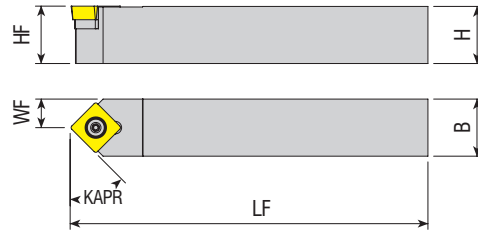

Takım Kodu Ordering Code Bestell-Bezeichnung	Stok Stock Lager		Takım Ölçüleri (mm) Dimension (mm) Abmessung (mm)				Kesici Uç Insert Wendeschneidplatte	Yedek Parçaları / Spare Parts / Ersatzteile			
	R	L	HF=H	B	LF	WF		Sıkma Vidası Screw Klemmschraube	Altlık Shim Unterlage	Altlık Vidası Shim Screw Schraube für Unterlage	Tork Anahtar Torx Key Torx-Schlüssel
SSDCN 1212 F09	●		12	12	80	6	SC.. 09T3..	4015-M3.5x11	-	-	80-T15
SSDCN 1616 H09	●		16	16	100	8		4015-M3.5x14	AASN-2-0001	AAV-06-M3.5x11	
SSDCN 2020 K09	●		20	20	125	10		4020-M4.5x12		AAV-10-M4.5x8	
SSDCN 1616 H12	●		16	16	100	8	SC.. 1204..	1020-M4.5x16	AASN-2-0004	AAV-07-M4.5x13	80-T20
SSDCN 2020 K12	●		20	20	125	10					
SSDCN 2525 M12	●		25	25	150	12.5					

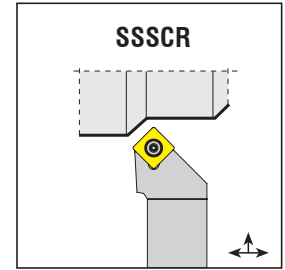
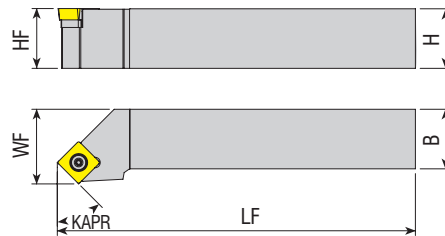

Takım Kodu Ordering Code Bestell-Bezeichnung	Stok Stock Lager		Takım Ölçüleri (mm) Dimension (mm) Abmessung (mm)				Kesici Uç Insert Wendeschneidplatte	Yedek Parçaları / Spare Parts / Ersatzteile			
	R	L	HF=H	B	LF	WF		Sıkma Vidası Screw Klemmschraube	Altlık Shim Unterlage	Altlık Vidası Shim Screw Schraube für Unterlage	Tork Anahtar Torx Key Torx-Schlüssel
SSSCR/L 1212 F09	●	●	12	12	80	16	SC.. 09T3..	4015-M3.5x11	-	-	80-T15
SSSCR/L 1616 H09	●	●	16	16	100	20		4015-M3.5x14	AASN-2-0001	AAV-06-M3.5x11	
SSSCR/L 2020 K09	●	●	20	20	125	25		4020-M4.5x12		AAV-10-M4.5x8	
SSSCR/L 1616 H12	●	●	16	16	100	20	SC.. 1204..	1020-M4.5x16	AASN-2-0004	AAV-07-M4.5x13	80-T20
SSSCR/L 2020 K12	●	●	20	20	125	25					
SSSCR/L 2525 M12	●	●	25	25	150	32					

R: Sağ / Right / Rechts L: Sol / Left / Links

● Stokta / In Stock / Auf Lager ○ Stokta Yok / Non Stock Item / Kein Lagerartikel, Lieferzeit auf Anfrage

Sipariş Örneği / Ordering Example / Bestellbeispiel

1 ad./pcs./stück SSDCN 1212 F09

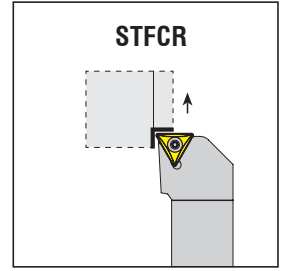
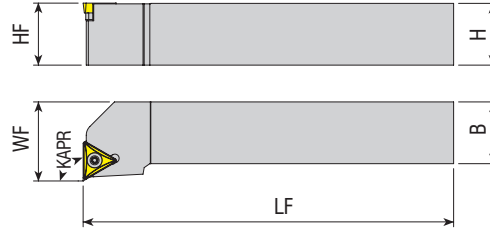

Takım Kodu
Ordering Code
Bestell-Bezeichnung

Stok Stock Lager		Takım Ölçüleri (mm) Dimension (mm) Abmessung (mm)				Kesici Uç Insert Wendeschneidplatte	Sıkma Vidası Screw Klemmschraube	Altlık Shim Unterlage	Altlık Vidası Shim Screw Schraube für Unterlage	Tork Anahtar Torx Key Torx-Schlüssel
R	L	HF=H	B	LF	WF					
○	○	08	08	70	10		3007-M2.2x4.6			82-T07
●	●	10	10	70	12	TC.. 1102..	4008-M2.5x6	-	-	82-T08
●	●	12	12	80	16					
●	●	16	16	100	20	TC.. 16T3..	4015-M3.5x14	AATN-2-0001	AAV-06-M3.5x11	80-T15
●	●	16	16	100	20					
●	●	20	20	125	25					
●	●	25	25	150	32					
●	●	32	32	170	40					

Yedek Parçaları / Spare Parts / Ersatzteile

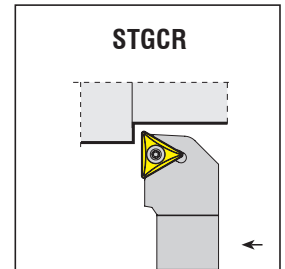
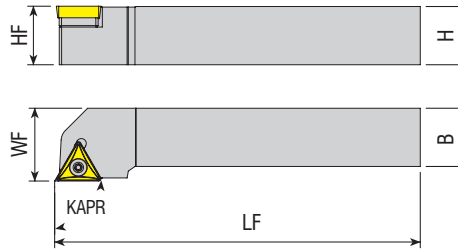

Takım Kodu
Ordering Code
Bestell-Bezeichnung

Stok Stock Lager		Takım Ölçüleri (mm) Dimension (mm) Abmessung (mm)				Kesici Uç Insert Wendeschneidplatte	Sıkma Vidası Screw Klemmschraube	Altlık Shim Unterlage	Altlık Vidası Shim Screw Schraube für Unterlage	Tork Anahtar Torx Key Torx-Schlüssel
R	L	HF=H	B	LF	WF					
●	●	08	08	70	10		3007-M2.2x4.6			82-T07
●	●	10	10	70	12	TC.. 1102..	4008-M2.5x6	-	-	82-T08
●	●	12	12	80	16					
●	●	16	16	100	20	TC.. 16T3..	4015-M3.5x14	AATN-2-0001	AAV-06-M3.5x11	80-T15
●	●	16	16	100	20					
●	●	20	20	125	25					
●	●	25	25	150	32					
●	●	32	32	170	40					

Yedek Parçaları / Spare Parts / Ersatzteile

R: Sağ / Right / Rechts L: Sol / Left / Links
● Stokta / In Stock / Auf Lager ○ Stokta Yok / Non Stock Item / Kein Lagerartikel, Lieferzeit auf Anfrage

Sipariş Örneği/Ordering Example/Bestellbeispiel
1 ad./pcs./stück STFCCR 0808 E09

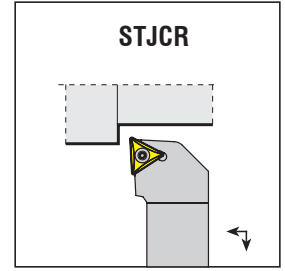
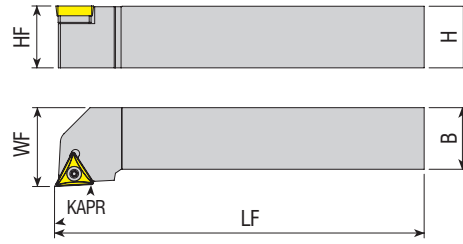
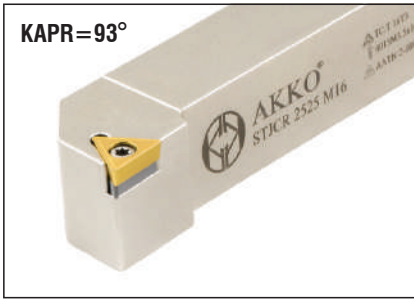

Takım Kodu
Ordering Code
Bestell-Bezeichnung

Stok Stock Lager		Takım Ölçüleri (mm) Dimension (mm) Abmessung (mm)				Kesici Uç Insert Wendeschneidplatte	Sıkma Vidası Screw Klemmschraube	Altlık Shim Unterlage	Altlık Vidası Shim Screw Schraube für Unterlage	Tork Anahtar Torx Key Torx-Schlüssel
R	L	HF=H	B	LF	WF					
●	●	08	08	70	10	TC.. 0902..	3007-M2.2x4.6		82-T07	
●	●	10	10	70	12					
●	●	12	12	80	16	TC.. 1102..	4008-M2.5x6		82-T08	
●	●	16	16	100	20					
●	●	16	16	100	20	TC.. 16T3..	4015-M3.5x14	AATN-2-0001	AAV-06-M3.5x11	
●	●	20	20	125	25					
●	●	25	25	150	32					
●	●	32	32	170	40					

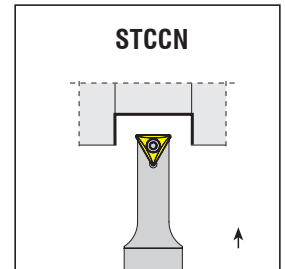
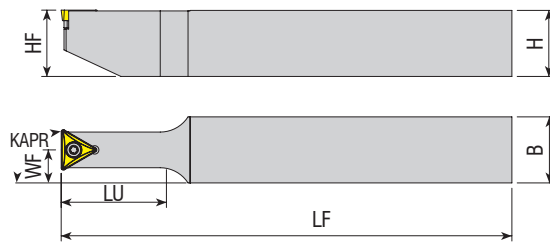

Takım Kodu
Ordering Code
Bestell-Bezeichnung

Stok Stock Lager		Takım Ölçüleri (mm) Dimension (mm) Abmessung (mm)				Kesici Uç Insert Wendeschneidplatte	Sıkma Vidası Screw Klemmschraube	Altlık Shim Unterlage	Altlık Vidası Shim Screw Schraube für Unterlage	Tork Anahtar Torx Key Torx-Schlüssel
		HF=H	B	LF	WF	LU				
●		20	20	140	10	50	TC.. 1102..	4008-M2.5x6		82-T08
●		16	16	125	8	24				
●		20	20	150	10	30	TC.. 16T3..	4015-M3.5x14	AATN-2-0001	AAV-06-M3.5x11
●		25	25	170	12.5	37.5				
●		32	32	200	16	48				
●		25	25	170	12.5	80				
							TC.. 2204..	4020-M4.5x12		

R: Sağ / Right / Rechts L: Sol / Left / Links

● Stokta / In Stock / Auf Lager ○ Stokta Yok / Non Stock Item / Kein Lagerartikel, Lieferzeit auf Anfrage

Sipariş Örneği/Ordering Example/Bestellbeispiel

1 ad./pcs./stück STJCR 0808 E09

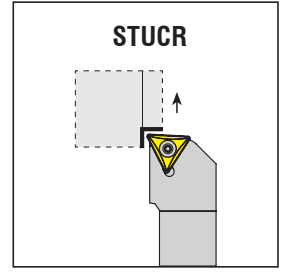
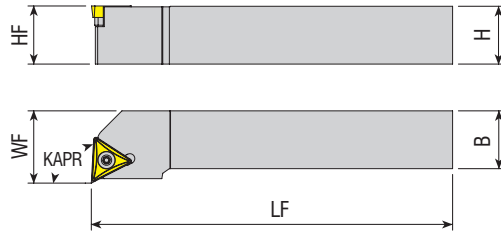

Takım Kodu
Ordering Code
Bestell-Bezeichnung

Stok Stock Lager	Takım Ölçüleri (mm) Dimension (mm) Abmessung (mm)						Kesici Uç Insert Wendeschneidplatte	Yedek Parçaları / Spare Parts / Ersatzteile			
	R	L	HF=H	B	LF	WF		Sıkma Vidası Screw Klemmschraube	Altlık Shim Unterlage	Altlık Vidası Shim Screw Schraube für Unterlage	Tork Anahtar Torx Key Torx-Schlüssel
●	●	08	08	70	10		TC.. 0902..	3007-M2.2x4.6	-	-	82-T07
●	●	10	10	70	12		TC.. 1102..	4008-M2.5x6	-	-	82-T08
○	○	16	16	100	20		TC.. 16T3..	4015-M3.5x14	AATN-2-0001	AAV-06-M3.5x11	80-T15
●	●	20	20	125	25						
●	●	25	25	150	32						
●	●	32	32	170	40						

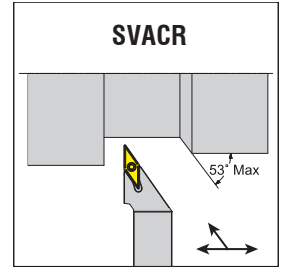
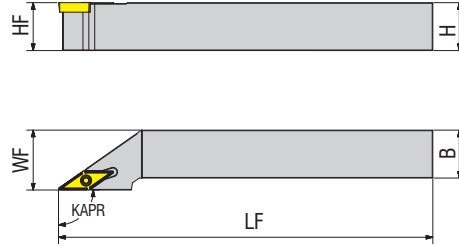

Takım Kodu
Ordering Code
Bestell-Bezeichnung

Stok Stock Lager	Takım Ölçüleri (mm) Dimension (mm) Abmessung (mm)						Kesici Uç Insert Wendeschneidplatte	Yedek Parçaları / Spare Parts / Ersatzteile			
	R	L	HF=H	B	LF	WF		Sıkma Vidası Screw Klemmschraube	Altlık Shim Unterlage	Altlık Vidası Shim Screw Schraube für Unterlage	Tork Anahtar Torx Key Torx-Schlüssel
●	●	12	12	125	16		VC.. 1103..	4008-M2.5x6	-	-	82-T08
●	●	16	16	125	20						
●	●	20	20	125	25						

R: Sağ / Right / Rechts L: Sol / Left / Links

● Stokta / In Stock / Auf Lager ○ Stokta Yok / Non Stock Item / Kein Lagerartikel, Lieferzeit auf Anfrage

Sipariş Örneği/Ordering Example/Bestellbeispiel

1 ad./pcs./stück STUCR 0808 E09

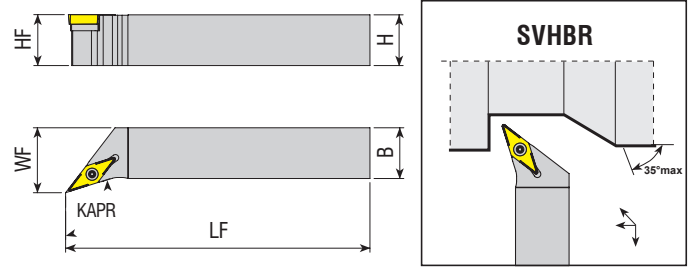
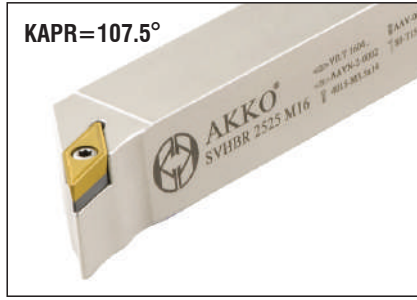

Takım Kodu
Ordering Code
Bestell-Bezeichnung

Stok Stock Lager	Takım Ölçüleri (mm) Dimension (mm) Abmessung (mm)					Kesici Uç Insert Wendeschneidplatte	Yedek Parçaları / Spare Parts / Ersatzteile			
	R	L	HF=H	B	LF		WF	Sıkma Vidası Screw Klemmschraube	Altlık Shim Unterlage	Altlık Vidası Shim Screw Schraube für Unterlage
●	●	12	12	80	16	VB.. 1103..	4008-M2.5x6	-	-	82-T08
●	●	16	16	100	20					
●	●	20	20	125	25					
●	●	20	20	125	25	VB.. 1604..	4015-M3.5x14	AAVN-2-0002	AAV-06-M3.5x11	80-T15
●	●	25	25	150	32					
●	●	32	32	170	40					

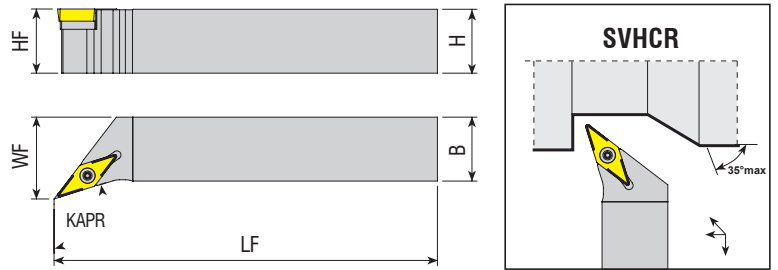
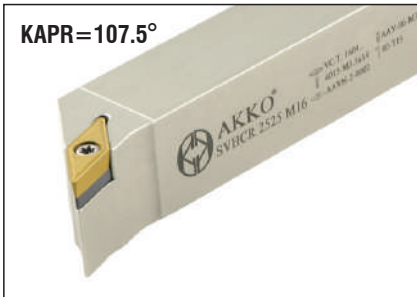

Takım Kodu
Ordering Code
Bestell-Bezeichnung

Stok Stock Lager	Takım Ölçüleri (mm) Dimension (mm) Abmessung (mm)					Kesici Uç Insert Wendeschneidplatte	Yedek Parçaları / Spare Parts / Ersatzteile			
	R	L	HF=H	B	LF		WF	Sıkma Vidası Screw Klemmschraube	Altlık Shim Unterlage	Altlık Vidası Shim Screw Schraube für Unterlage
●	●	12	12	80	16	VC.. 1103..	4008-M2.5x6	-	-	82-T08
●	●	16	16	100	20					
●	●	20	20	125	25					
●	●	20	20	125	25	VC.. 1604..	4015-M3.5x14	AAVN-2-0002	AAV-06-M3.5x11	80-T15
●	●	25	25	150	32					
●	●	32	32	170	40					

R: Sağ / Right / Rechts L: Sol / Left / Links

● Stokta / In Stock / Auf Lager ○ Stokta Yok / Non Stock Item / Kein Lagerartikel, Lieferzeit auf Anfrage

Sipariş Örneği/Ordering Example/Bestellbeispiel

1 ad./pcs./stück SVHBR 1212 F11

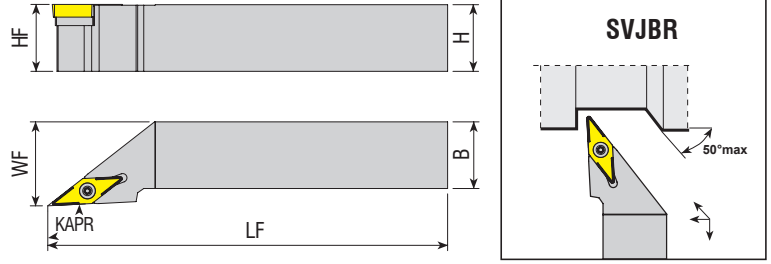

Takım Kodu
Ordering Code
Bestell-Bezeichnung

Stok Stock Lager	Takım Ölçüleri (mm) Dimension (mm) Abmessung (mm)						Kesici Uç Insert Wendeschneidplatte	Yedek Parçaları / Spare Parts / Ersatzteile			
	R	L	HF=H	B	LF	WF		Sıkma Vidası Screw Klemmschraube	Altık Shim Unterlage	Altık Vidası Shim Screw Schraube für Unterlage	Tork Anahtar Torx Key Torx-Schlüssel
●	●	12	12	80	16	VB.. 1103..			-	-	82-T08
●	●	16	16	100	20						
●	●	20	20	125	25						
●	●	16	16	100	20	VB.. 1604..			AAVN-2-0002	AAV-06-M3.5x11	80-T15
●	●	20	20	125	25						
●	●	25	25	150	32						
●	●	32	32	170	40						

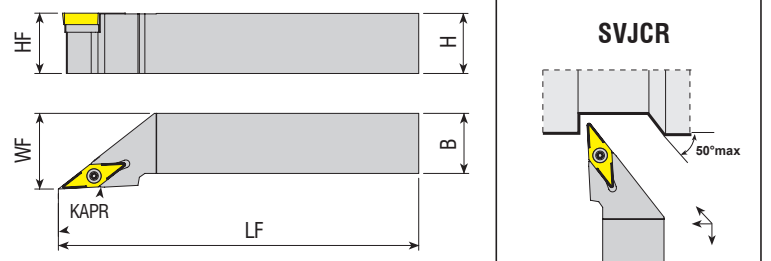

Takım Kodu
Ordering Code
Bestell-Bezeichnung

Stok Stock Lager	Takım Ölçüleri (mm) Dimension (mm) Abmessung (mm)						Kesici Uç Insert Wendeschneidplatte	Yedek Parçaları / Spare Parts / Ersatzteile			
	R	L	HF=H	B	LF	WF		Sıkma Vidası Screw Klemmschraube	Altık Shim Unterlage	Altık Vidası Shim Screw Schraube für Unterlage	Tork Anahtar Torx Key Torx-Schlüssel
●	●	12	12	80	16	VC.. 1103..			-	-	82-T08
●	●	16	16	100	20						
●	●	20	20	125	25						
●	●	12	12	80	16	VC.. 1604...			AAVN-2-0002	AAV-06-M3.5x11	80-T15
●	●	20	20	125	25						
●	●	25	25	150	32						
●	●	32	32	170	40						

R: Sağ / Right / Rechts L: Sol / Left / Links

● Stokta / In Stock / Auf Lager ○ Stokta Yok / Non Stock Item / Kein Lagerartikel, Lieferzeit auf Anfrage

Sipariş Örneği/Ordering Example/Bestellbeispiel

1 ad./pcs./stück SVJBR 1212 F11

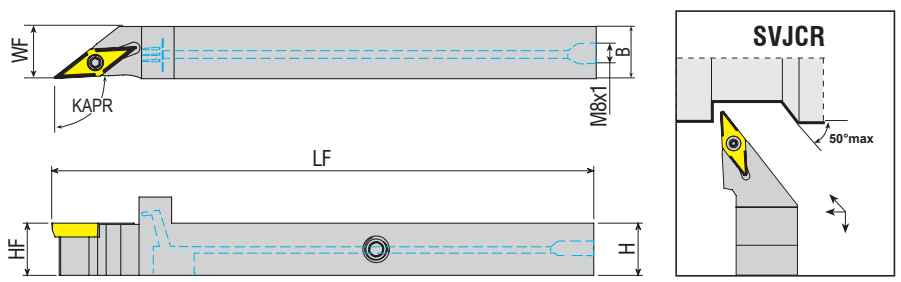

Takım Kodu Ordering Code Bestell-Bezeichnung	Stok Stock Lager		Takım Ölçüleri (mm) Dimension (mm) Abmessung (mm)				Kesici Uç Insert Wendeschneidplatte	Sıkma Vidası Screw Klemmschraube	Altlık Shim Unterlage	Altlık Vidası Shim Screw Schraube für Unterlage	Sızdırmaz Vida Threaded Pin Gewindestift	Anahtar Allen Key Innensechskantschlüssel	Tork Anahtar Torx Key Torx-Schlüssel
	R	L	HF=H	B	LF	WF							
SVJCR/L 1212 K11-SHC	●	○	12	12	125	12	VC.. 1103..	4008-M2.5x6	-	-	2703-M6X4	AAL-03-3	82-T08
SVJCR/L 1616 K11-SHC	●	○	16	16	125	16					2704-M8X1X5	AAL-05-4	

S-SİSTEM DIŞ TORNA KATERLERİ
S-SYSTEM EXTERNAL TURNING TOOLHOLDERS
S-SYSTEM AUSSEN - DREHHALTER

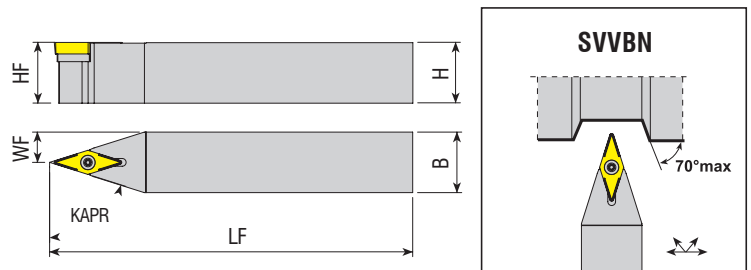

Takım Kodu Ordering Code Bestell-Bezeichnung	Stok Stock Lager		Takım Ölçüleri (mm) Dimension (mm) Abmessung (mm)				Kesici Uç Insert Wendeschneidplatte	Sıkma Vidası Screw Klemmschraube	Altlık Shim Unterlage	Altlık Vidası Shim Screw Schraube für Unterlage	Tork Anahtar Torx Key Torx-Schlüssel
	R	L	HF=H	B	LF	WF					
SVVBN 1212 F11	●		12	12	80	06	VB.. 1103..	4008-M2.5x6	-	-	82-T08
SVVBN 1616 H11	●		16	16	100	08					
SVVBN 2020 K11	●		20	20	125	10					
SVVBN 2020 K16	●		20	20	125	10	VB.. 1604..	4015-M3.5x14	AAVN-2-0002	AAV-06-M3.5x11	80-T15
SVVBN 2525 M16	●		25	25	150	12.5					
SVVBN 3232 P16	●		32	32	170	16					

R: Sağ / Right / Rechts L: Sol / Left / Links
● Stokta / In Stock / Auf Lager ○ Stokta Yok / Non Stock Item / Kein Lagerartikel, Lieferzeit auf Anfrage

Sipariş Örneği/Ordering Example/Bestellbeispiel
1 ad./pcs./stück SVJCR 1212 K11-SHC

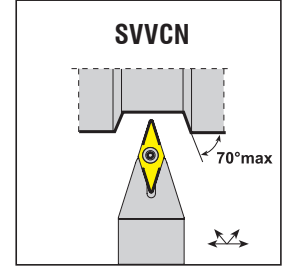
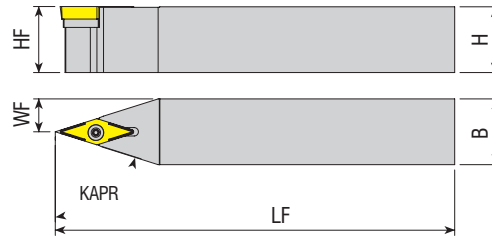

Takım Kodu Ordering Code Bestell-Bezeichnung	Stok Stock Lager	Takım Ölçüleri (mm) Dimension (mm) Abmessung (mm)				Kesici Uç Insert Wendeschneidplatte	Yedek Parçaları / Spare Parts / Ersatzteile			
		HF=H	B	LF	WF		Sıkma Vidası Screw Klemmschraube	Altlık Shim Unterlage	Altlık Vidası Shim Screw Schraube für Unterlage	Tork Anahtar Torx Key Torx-Schlüssel
SVVCN 1212 F11	●	12	12	80	06	VC.. 1103..	4008-M2.5x6	-	-	82-T08
SVVCN 1616 H11	●	16	16	100	08					
SVVCN 2020 K11	●	20	20	125	10					
SVVCN 2020 K16	●	20	20	125	10	VC.. 1604...	4015-M3.5x14	AAVN-2-0002	AAV-06-M3.5x11	80-T15
SVVCN 2525 M16	●	25	25	150	12.5					
SVVCN 3232 P16	●	32	32	170	16					

S-SİSTEM İSVİÇRE TİPİ KAYAR OTOMAT MAKİNA TAKIMLARI
S-SYSTEM TOOLS FOR SWISS TYPE SLIDING AUTOMATIC LATHES
S-SYSTEM FÜR LANGDREHAUTOMATEN

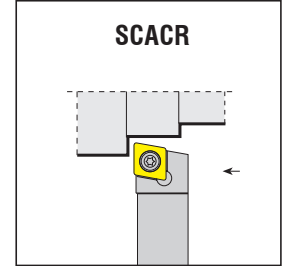
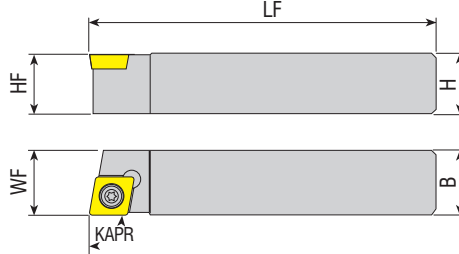
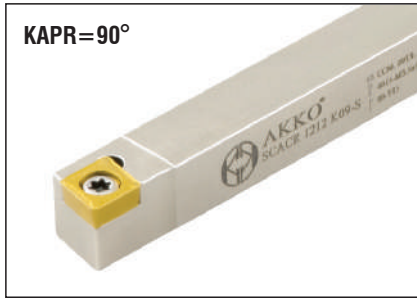

Takım Kodu Ordering Code Bestell-Bezeichnung	Stok Stock Lager		Takım Ölçüleri (mm) Dimension (mm) Abmessung (mm)				Kesici Uç Insert Wendeschneidplatte	Yedek Parçaları / Spare Parts / Ersatzteile			
	R	L	HF=H	B	LF	WF		Sıkma Vidası Screw Klemmschraube	Altlık Shim Unterlage	Altlık Vidası Shim Screw Schraube für Unterlage	Tork Anahtar Torx Key Torx-Schlüssel
SCACR/L 0808 X06-S	●	●	08	08	115	08	CC.. 0602..	4008-M2.5x6	-	-	82-T08
SCACR/L 1010 K06-S	●	○	10	10	125	10					
SCACR/L 1212 G06-S	●	○	12	12	90	12					
SCACR/L 1212 K06-S	●	○	12	12	125	12					
SCACR/L 1616 F06-S	○	○	16	16	75	16					
SCACR/L 1616 K06-S	○	○	16	16	125	16					
SCACR/L 1212 G09-S	○	○	12	12	90	12	CC.. 09T3..	4015-M3.5x11	-	-	80-T15
SCACR/L 1212 K09-S	●	●	12	12	125	12					
SCACR/L 1616 F09-S	○	○	16	16	75	16					
SCACR/L 1616 K09-S	●	●	16	16	125	16					
SCACR/L 2020 K09-S	●	●	20	20	125	20					

R: Sağ / Right / Rechts L: Sol / Left / Links

● Stokta / In Stock / Auf Lager ○ Stokta Yok / Non Stock Item / Kein Lagerartikel, Lieferzeit auf Anfrage

Sipariş Örneği/Ordering Example/Bestellbeispiel

1 ad./pcs./stück SVVCN 1212 F11

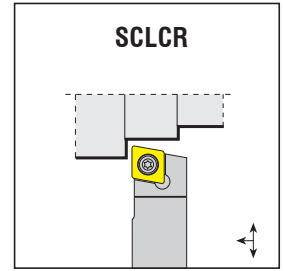
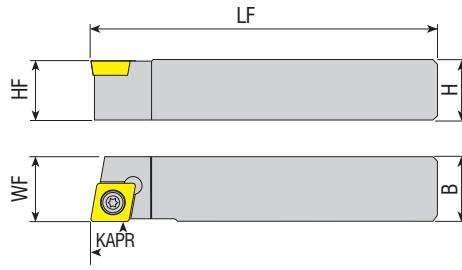
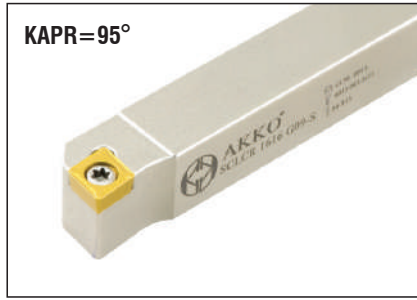

Takım Kodu
Ordering Code
Bestell-Bezeichnung

Stok Stock Lager	Takım Ölçüleri (mm) Dimension (mm) Abmessung (mm)						Kesici Uç Insert Wendeschneidplatte	Yedek Parçaları / Spare Parts / Ersatzteile			
	R	L	HF=H	B	LF	WF		Sıkma Vidası Screw Klemmschraube	Altlık Shim Unterlage	Altlık Vidası Shim Screw Schraube für Unterlage	Tork Anahtar Torx Key Torx-Schlüssel
●	●	08	08	115	08	CC.. 0602..					
●	○	10	10	115	10						
●	●	12	12	90	12						
●	○	12	12	130	12						
○	●	12	12	125	12						
●	○	16	16	75	16						
●	○	16	16	130	16						
●	●	12	12	90	12	CC.. 09T3..					
●	○	12	12	130	12						
●	○	16	16	75	16						
●	○	16	16	90	16						
●	○	16	16	90	16						
●	○	16	16	115	16						
●	○	20	20	120	20						

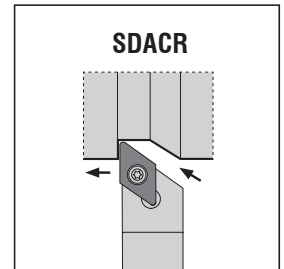
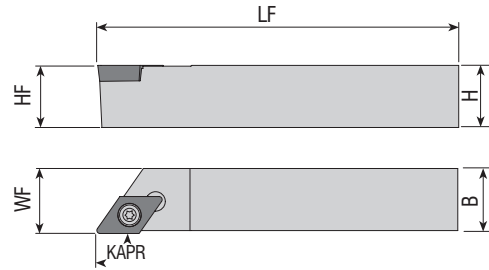

Takım Kodu
Ordering Code
Bestell-Bezeichnung

Stok Stock Lager	Takım Ölçüleri (mm) Dimension (mm) Abmessung (mm)						Kesici Uç Insert Wendeschneidplatte	Yedek Parçaları / Spare Parts / Ersatzteile			
	R	L	HF=H	B	LF	WF		Sıkma Vidası Screw Klemmschraube	Altlık Shim Unterlage	Altlık Vidası Shim Screw Schraube für Unterlage	Tork Anahtar Torx Key Torx-Schlüssel
●	●	08	08	115	08	DC.. 0702..					
●	●	10	10	125	10						
○	○	12	12	90	12						
●	●	12	12	125	12						
●	○	16	16	75	16						
●	●	16	16	125	16						
○	○	12	12	90	12						
●	●	12	12	125	12						
●	●	16	16	75	16						
●	●	16	16	125	16						
●	●	16	16	125	16						
●	●	20	20	125	20						

R: Sağ / Right / Rechts L: Sol / Left / Links

● Stokta / In Stock / Auf Lager ○ Stokta Yok / Non Stock Item / Kein Lagerartikel, Lieferzeit auf Anfrage

Sipariş Örneği/Ordering Example/Bestellbeispiel

1 ad./pcs./stück SCLCR 0808 X06-S

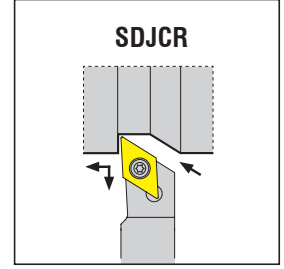
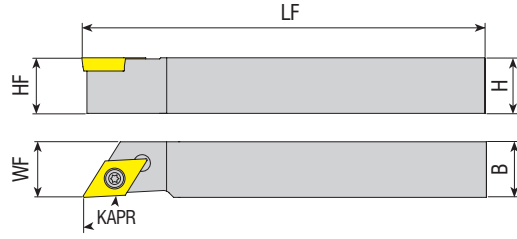
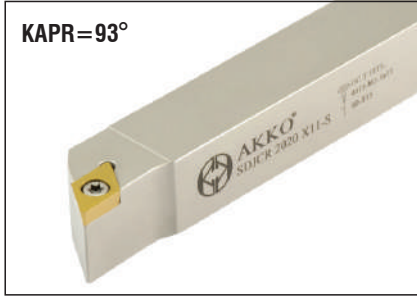

Takım Kodu Ordering Code Bestell-Bezeichnung	Stok Stock Lager		Takım Ölçüleri (mm) Dimension (mm) Abmessung (mm)				Kesici Uç Insert Wendeschneidplatte	Yedek Parçaları / Spare Parts / Ersatzteile			
	R	L	HF=H	B	LF	WF		Sıkma Vidası Screw Klemmschraube	Altlık Shim Unterlage	Altlık Vidası Shim Screw Schraube für Unterlage	Tork Anahtar Torx Key Torx-Schlüssel
SDJCR/L 0808 X07-S	●	○	08	08	115	08	DC.. 0702..	4008-M2.5x6	-	-	82-T08
SDJCR/L 1010 X07-S	●	●	10	10	115	10					
SDJCR/L 1212 G07-S	●	○	12	12	90	12					
SDJCR/L 1212 X07-S	●	●	12	12	130	12					
SDJCR/L 1616 F07-S	●	○	16	16	75	16					
SDJCR/L 1616 X07-S	●	○	16	16	130	16					
SDJCR/L 2020 X07-S	●	○	20	20	120	20	DC.. 11T3..	4015-M3.5x11	-	-	80-T15
SDJCR/L 1212 G11-S	●	○	12	12	90	12					
SDJCR/L 1212 X11-S	●	●	12	12	130	12					
SDJCR/L 1212 K11-S	●	●	12	12	125	12					
SDJCR/L 1616 F11-S	●	○	16	16	75	16					
SDJCR/L 1616 X11-S	●	●	16	16	130	16					
SDJCR/L 1616 K11-S	●	●	16	16	125	16					
SDJCR/L 2020 X11-S	●	○	20	20	120	20					

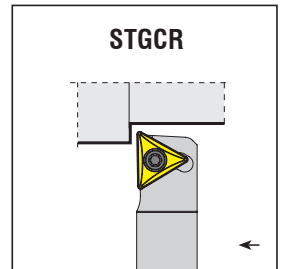
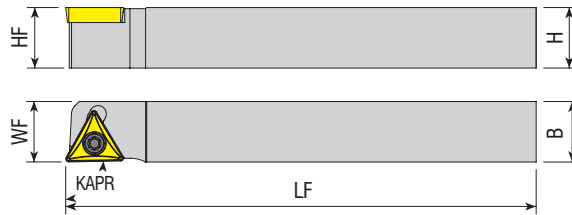

Takım Kodu Ordering Code Bestell-Bezeichnung	Stok Stock Lager		Takım Ölçüleri (mm) Dimension (mm) Abmessung (mm)				Kesici Uç Insert Wendeschneidplatte	Yedek Parçaları / Spare Parts / Ersatzteile			
	R	L	HF=H	B	LF	WF		Sıkma Vidası Screw Klemmschraube	Altlık Shim Unterlage	Altlık Vidası Shim Screw Schraube für Unterlage	Tork Anahtar Torx Key Torx-Schlüssel
STGCR/L 1216 K11-S	●	○	12	16	125	16	TC.. 1102..	4008-M2.5x6	-	-	82-T08
STGCR/L 1616 K11-S	●	○	16	16	125	16					
STGCR/L 1216 K16-S	●	○	12	16	125	16	TC.. 16T3..	4015-M3.5x11	-	-	80-T15
STGCR/L 1616 K16-S	●	○	16	16	125	16					

R: Sağ / Right / Rechts L: Sol / Left / Links

● Stokta / In Stock / Auf Lager ○ Stokta Yok / Non Stock Item / Kein Lagerartikel, Lieferzeit auf Anfrage

Sipariş Örneği/Ordering Example/Bestellbeispiel

1 ad./pcs./stück SDJCR 0808 X07-S

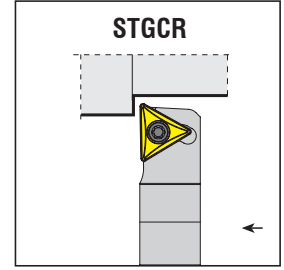
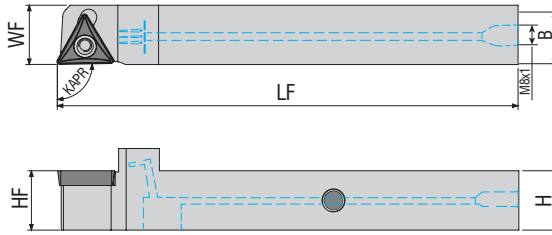

Takım Kodu Ordering Code Bestell-Bezeichnung	Stok Stock Lager		Takım Ölçüleri (mm) Dimension (mm) Abmessung (mm)				Kesici Uç Insert Wendeschneidplatte	Yedek Parçaları / Spare Parts / Ersatzteile				
	R	L	HF=H	B	LF	WF		Sıkma Vidası Screw Klemmschraube	Sızdırmaz Vida Threaded Pin Gewindestift	Anahtar Allen Key Innensechskantschlüssel	Tork Anahtar Torx Key Torx-Schlüssel	
STGCR/L 1216 K16-SHC	●	○	12	16	125	16	TC.. 16T3..	4015-M3.5x11	2703-M6X4	AAL-03-3	80-T15	
STGCR/L 1616 K16-SHC	●	○	16	16	125	16			2704-M8X1X5	AAL-05-4		

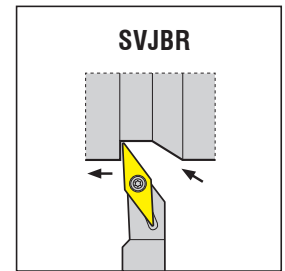
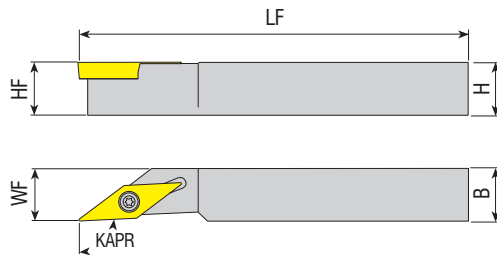

Takım Kodu Ordering Code Bestell-Bezeichnung	Stok Stock Lager		Takım Ölçüleri (mm) Dimension (mm) Abmessung (mm)				Kesici Uç Insert Wendeschneidplatte	Yedek Parçaları / Spare Parts / Ersatzteile				
	R	L	HF=H	B	LF	WF		Sıkma Vidası Screw Klemmschraube	Altlık Shim Unterlage	Altlık Vidası Shim Screw Schraube für Unterlage	Tork Anahtar Torx Key Torx-Schlüssel	
SVJBR/L 1616 K11-S	●	●	16	16	125	16	VB.. 1103..	4008-M2.5x6	-	-	82-T08	

R: Sağ / Right / Rechts L: Sol / Left / Links
● Stokta / In Stock / Auf Lager ○ Stokta Yok / Non Stock Item / Kein Lagerartikel, Lieferzeit auf Anfrage

Sipariş Örneği/Ordering Example/Bestellbeispiel
1 ad./pcs./stück STGCR 1216 K16-SHC

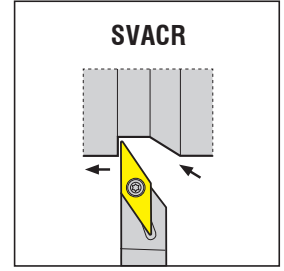
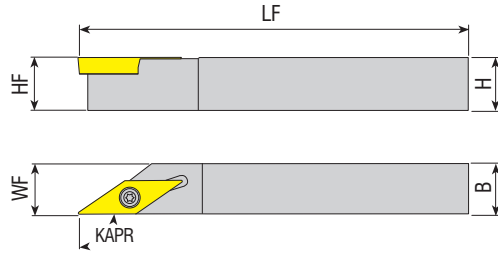

Takım Kodu Ordering Code Bestell-Bezeichnung	Stok Stock Lager		Takım Ölçüleri (mm) Dimension (mm) Abmessung (mm)				Kesici Uç Insert Wendeschneidplatte	Yedek Parçaları / Spare Parts / Ersatzteile			
	R	L	HF=H	B	LF	WF		Sıkma Vidası Screw Klemmschraube	Altlık Shim Unterlage	Altlık Vidası Shim Screw Schraube für Unterlage	Tork Anahtar Torx Key Torx-Schlüssel
SVACR/L 0808 X11-S	○	○	08	08	115	08	VC.. 1103..	4008-M2.5x6	-	-	82-T08
SVACR/L 1010 K11-S	●	○	10	10	125	10					
SVACR/L 1212 G11-S	○	○	12	12	90	12					
SVACR/L 1212 K11-S	●	●	12	12	125	12					
SVACR/L 1616 F11-S	○	○	16	16	75	16					
SVACR/L 1616 K11-S	●	●	16	16	125	16					
SVACR/L 2020 K11-S	●	●	20	20	125	20					
SVACR/L 1212 K16-S	●	●	12	12	125	12	VC.. 1604...	4015-M3.5x11		80-T15	
SVACR/L 1616 K16-S	●	●	16	16	125	16					

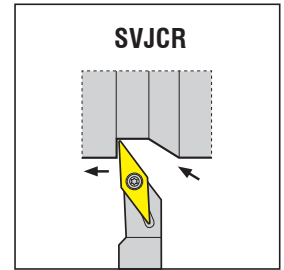
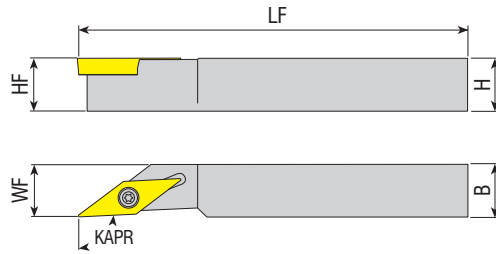

Takım Kodu Ordering Code Bestell-Bezeichnung	Stok Stock Lager		Takım Ölçüleri (mm) Dimension (mm) Abmessung (mm)				Kesici Uç Insert Wendeschneidplatte	Yedek Parçaları / Spare Parts / Ersatzteile			
	R	L	HF=H	B	LF	WF		Sıkma Vidası Screw Klemmschraube	Altlık Shim Unterlage	Altlık Vidası Shim Screw Schraube für Unterlage	Tork Anahtar Torx Key Torx-Schlüssel
SVJCR/L 0808 X11-S	●	○	08	08	115	08	VC.. 1103..	4008-M2.5x6	-	-	82-T08
SVJCR/L 1010 K11-S	●	○	10	10	125	10					
SVJCR/L 1212 G11-S	●	○	12	12	90	12					
SVJCR/L 1212 K11-S	●	●	12	12	125	12					
SVJCR/L 1616 F11-S	○	○	16	16	75	16					
SVJCR/L 1616 K11-S	●	○	16	16	125	16					
SVJCR/L 2020 K11-S	○	○	20	20	125	20					
new SVJCR/L 1616 K16-S	●	●	16	16	125	16	VC.. 1604...	4015-M3.5x14	AAVN-2-0002	AAV-08-M3.5x8 AAV-06-M3.5x11	80-T15
new SVJCR/L 2020 K16-S	●	●	20	20	125	20					

R: Sağ / Right / Rechts L: Sol / Left / Links

● Stokta / In Stock / Auf Lager ○ Stokta Yok / Non Stock Item / Kein Lagerartikel, Lieferzeit auf Anfrage

Sipariş Örneği/Ordering Example/Bestellbeispiel

1 ad./pcs./stück SVACR 0808 X11-S

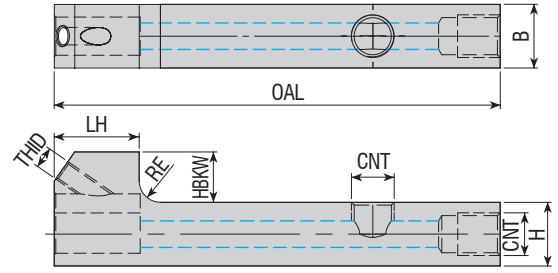
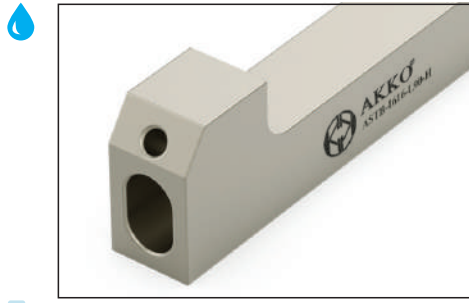

Takım Kodu Ordering Code Bestell-Bezeichnung	Stok Stock Lager		Takım Ölçüleri (mm) Dimension (mm) Abmessung (mm)							Yedek Parçaları / Spare Parts / Ersatzteile		
	H	B	RE	HBKW	LH	OAL	CNT	THID	Sızdırmaz Vida Threaded Pin Gewindestift	Montaj Vidası Mounting Screw Монтажный винт	Anahtar Allen Key Innensechskantschlüssel	
ASTB-1212-L84-H	●	12	12	4	9.5	16	84	M8X1X5	M4x0.7	2704-M8X1X5	2503-M4x12-C	AAL-03-3
ASTB-1616-L90-H	●	16	16	1	5.5	16	90	M8X1X5	M4x0.7			

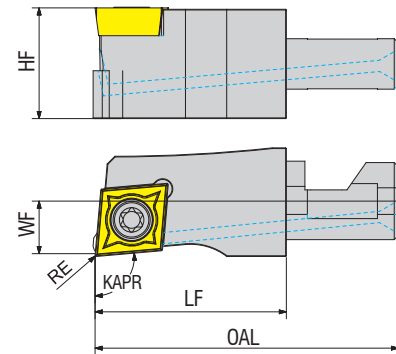



Takım Kodu Ordering Code Bestell-Bezeichnung	Stok Stock Lager		Takım Ölçüleri (mm) Dimension (mm) Abmessung (mm)					Kesici Uç Insert Wendeschneidplatte	Yedek Parçaları / Spare Parts / Ersatzteile	
	R	L	HF	WF	RE	LF	OAL	Sıkma Vidası Screw Klemmschraube	Tork Anahtar Torx Key Torx-Schlüssel	
SCLCR/L-12X43.3-06-H	●	●	11.8	8	0.2	27.3	43.3	CC.. 0602..	4008-M2.5x6	82-T08
SCLCR/L-16X43.3-06-H	●	●	15.8	8	0.2	27.3	43.3			
SCLCR/L-12X43.3-09-H	●	●	11.8	8	0.2	27.3	43.3	CC.. 09T3..	4015-M3.5x8	80-T15
SCLCR/L-16X43.3-09-H	●	●	15.8	8	0.2	27.3	43.3			

R: Sağ / Right / Rechts L: Sol / Left / Links

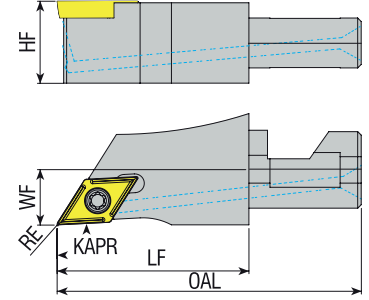

● Stokta / In Stock / Auf Lager ○ Stokta Yok / Non Stock Item / Kein Lagerartikel, Lieferzeit auf Anfrage

Sipariş Örneği/Ordering Example/Bestellbeispiel
1 ad./pcs./stück ASTB-1212-L84-H

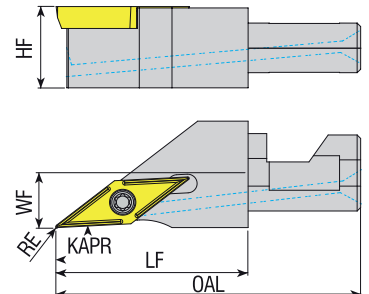

Takım Kodu Ordering Code Bestell-Bezeichnung	Stok Stock Lager		Takım Ölçüleri (mm) Dimension (mm) Abmessung (mm)					Kesici Uç Insert Wendescheidplatte	Yedek Parçaları / Spare Parts / Ersatzteile		
	R	L	HF	WF	RE	LF	OAL		Sıkma Vidası Screw Klemmschraube	Tork Anahtar Torx Key Torx-Schlüssel	
SDJCR/L 12X43.3-07	●	●	11.8	8	0.2	27.3	43.3				
SDJCR/L 12X43.3-07-H	●	●	11.8	8	0.2	27.3	43.3				
SDJCR/L 16X43.3-07	●	●	15.8	8	0.2	27.3	43.3				
SDJCR/L 16X43.3-07-H	●	●	15.8	8	0.2	27.3	43.3				
SDJCR/L 12X43.3-11	●	●	11.8	8	0.2	27.3	43.3				
SDJCR/L 12X43.3-11-H	●	●	11.8	8	0.2	27.3	43.3				
SDJCR/L 16X43.3-11	●	●	15.8	8	0.2	27.3	43.3				
SDJCR/L 16X43.3-11-H	●	●	15.8	8	0.2	27.3	43.3				



Takım Kodu Ordering Code Bestell-Bezeichnung	Stok Stock Lager		Takım Ölçüleri (mm) Dimension (mm) Abmessung (mm)					Kesici Uç Insert Wendescheidplatte	Yedek Parçaları / Spare Parts / Ersatzteile		
	R	L	HF	WF	RE	LF	OAL		Sıkma Vidası Screw Klemmschraube	Tork Anahtar Torx Key Torx-Schlüssel	
SVJCR/L 12X43.3-11	●	●	11.8	8	0.2	27.3	43.3				
SVJCR/L 12X43.3-11-H	●	●	11.8	8	0.2	27.3	43.3				
SVJCR/L 16X43.3-11	●	●	15.8	8	0.2	27.3	43.3				
SVJCR/L 16X43.3-11-H	●	●	15.8	8	0.2	27.3	43.3				

R: Sağ / Right / Rechts L: Sol / Left / Links
 ● Stokta / In Stock / Auf Lager ○ Stokta Yok / Non Stock Item / Kein Lagerartikel, Lieferzeit auf Anfrage

Sipariş Örneği/Ordering Example/Bestellbeispiel
 1 ad./pcs./stück SDJCR/L 12X43.3-07

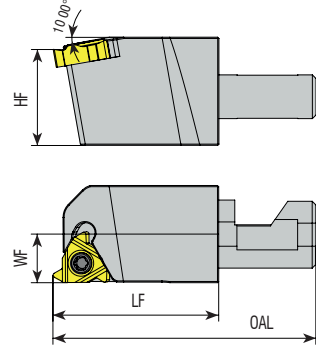
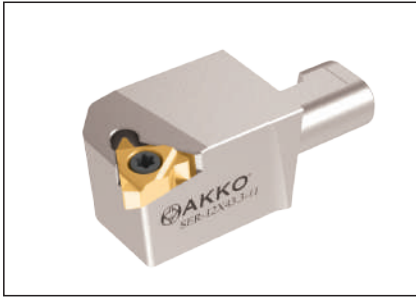

Takım Kodu
Ordering Code
Bestell-Bezeichnung

Stok Stock Lager		Takım Ölçüleri (mm) Dimension (mm) Abmessung (mm)					Kesici Uç Insert Wendeschneidplatte	Sıkma Vidası Screw Klemmschraube	Sağ Altlık Right Shim U-Platte für WSP rechts	Sol Altlık Left Shim U-Platte für WSP links	Altık Vidası Shim Screw Schraube für Unterlage	Altık Vidası Pulu Shim Screw Ring Schraube für Unterlagerung	Tork Anahtar Torx Key Torx-Schlüssel
R	L	OAL	LF	WF	HF								
●	●	43.3	27.3	8	11.8								
SER/L-12x43.3-11						11 ER/EL	4008-M2.5x6	-	-	-	-	82-T08	
SER/L-16x43.3-11						16 ER/EL	1710-U5-40x12.2	ATS-16E	ATS-16I	AAV-11-U5-40x4.5	ABPL-03	82-T10	
TER/L-16x43.3-16													

Sipariş Örneği/Ordering Example/Bestellbeispiel
1 ad./pcs./stück SER-12x43.3-11

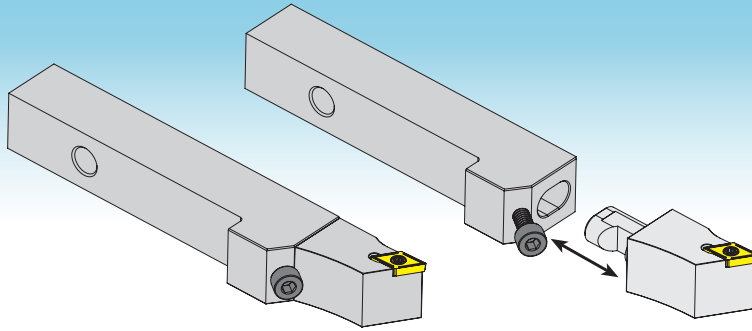

Takım tutucuyu, bağlama ünitesinden sökme zorunluğu kalmadan hızlıca değiştirin!

Quick change, without having to remove the tool-holder from the gang !

Es ist nicht nötig, den Grundhalter vom Werkzeugträger zu entfernen schnelle wechsel möglich!

Makina dışında ön ayar yapmak mümkün.

Presetting is possible outside of the machine.

Voreinstellung ausserhalb der Maschine ist möglich.

Çok hassas montaj.

Ultra precise fitting.

Ultra-präziser Montage.

Rijit sabitleme.

Rigid fixation.

Starre Befestigung.

Takım tutucu bölümü: 12x12 ve 16x16 mm.

Tool-holder section : 12x12 and 16x16 mm.

Grundhalter: 12x12 und 16x16mm.

Sağ ve sol uçlar kullanılır.

Left and right inserts available.

Links und Rechts WSP verwendbar.

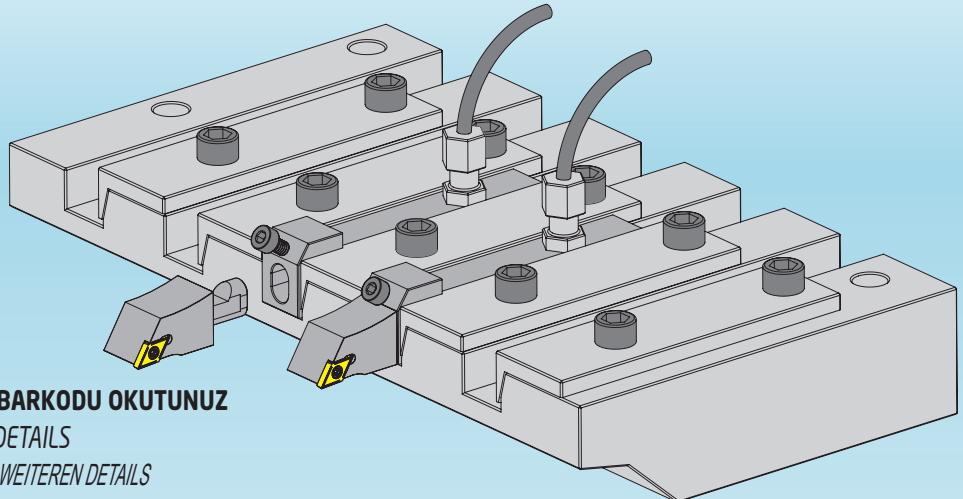
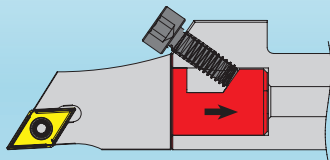

DETAYLI BİLGİ İÇİN BARKODU OKUTUNUZ
SCAN ME FOR MORE DETAILS
SCANNEN SIE MICH NACH WEITEREN DETAILS



DELİK TORNA TAKIMLARI
INTERNAL TURNING TOOLHOLDERS
DREHWERKZEUGE FÜR DIE INNENBEARBEITUNG





S **25** **S** | **P** **C** **L** **N** **R** **12** **C**

1 Takım Malzemesi / Type of Boring Bar / Art der Bohrstange

"A" Yekpare çelik gövde soğutma suyu kanallı / "A" Solid steel with coolant hole
 "A" Vollstahlausführung mit innere Kühlmittelzufuhr
 "E" Carbide bar with fixed steel head and coolant hole
 "E" Hartmetallschaft mit Kopf aus Stahl und innere Kühlmittelzufuhr
 "C" Karbür Şaft / "C" Carbide shank / "C" Hartmetallschaft mit Kopf aus Stahl ohne innere Kühlmittelzufuhr
 "S" Çelik Şaft / "S" Steel shank / "S" Vollstahlausführung ohne innere Kühlmittelzufuhr

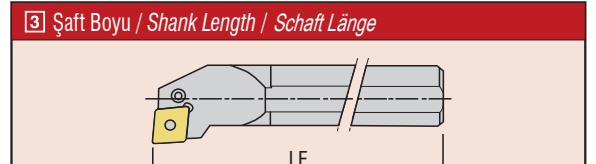

4 Sıkma Tipi / Method of Mounting of Insert / Art der Schneideplattenbefestigung

 Deliksiz Üstten Sıkma Top Clamping Without Hole Pratzenklemmung	 Üstten Delikli Sıkma Top and Hole Clamping Keilspannspritzensystem	 Üstten ve Delikten Sıkma Top and Hole Clamping Keilspannspritzensystem	 Delikten Levye ile Sıkma Hole Clamping (Lever Lock) Kniehebel-Spannsystem	 Vida ile Sıkma Screw on Schrauben-Spannsystem
C	T	M	P	S

A - 32	H - 100	Q - 180	x-special
B - 40	J - 110	R - 200	
C - 50	K - 125	S - 250	
D - 60	L - 140	T - 300	
E - 70	M - 150	U - 350	
F - 80	N - 160	V - 400	
G - 90	P - 170	W - 450	

(mm)

5 Uç Tipi / Type of Insert / Plattenform

 C	 D	 E
 V	 R	 S
 W	 K	 T

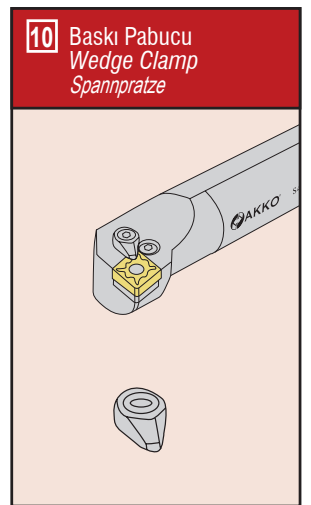
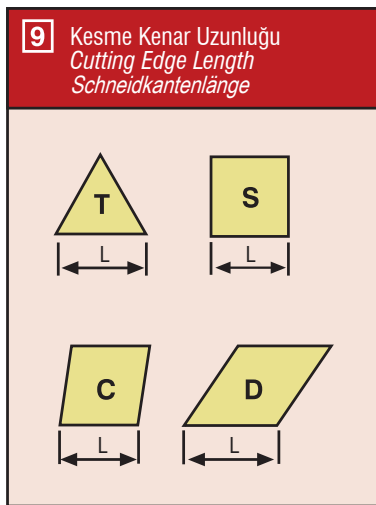
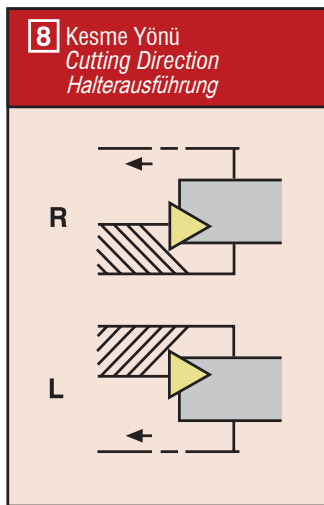
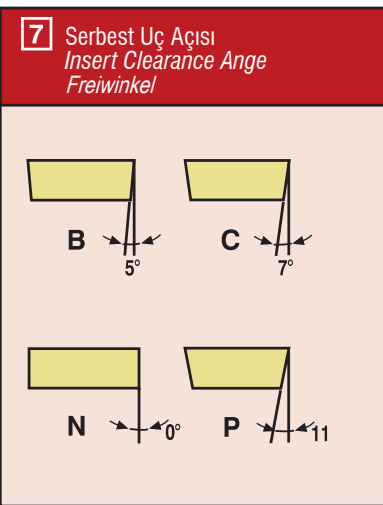
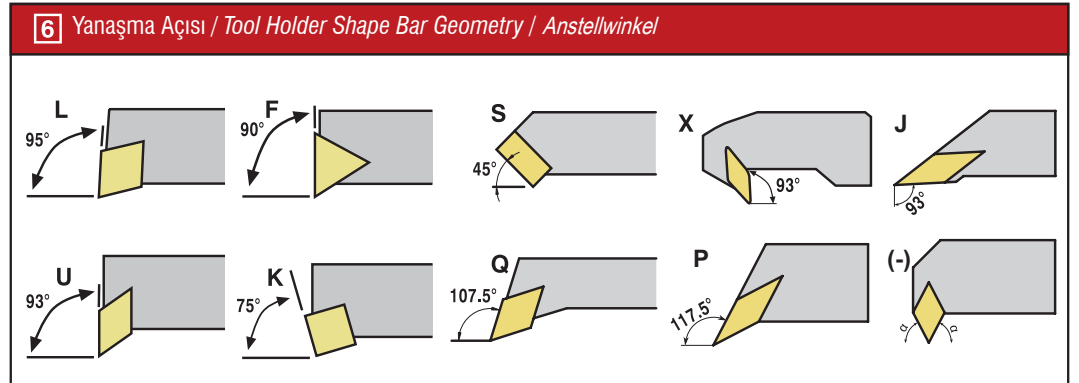



konusulan
the spoken kalite...
quality...

T&C-SİSTEM

T&C SİSTEM DELİK TORNA KATERLERİ
T&C SYSTEM BORING BARS
T&C SYSTEM BOHRSTANGE





KAPR=75°

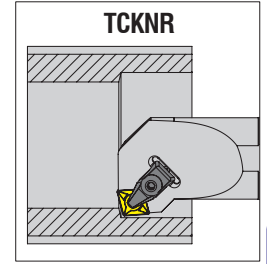
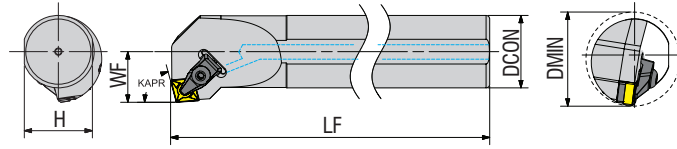

Takım Kodu Ordering Code Bestell-Bezeichnung	Stok Stock Lager		Takım Ölçüleri (mm) Dimension (mm) Abmessung (mm)					Kesici Uç Insert Wendeschneidplatte	Yedek Parçaları / Spare Parts / Ersatzteile						
	R	L	DCON	H	LPR	WF	DMIN		Baskı Pabucu Wedge Clamp Spannpratze	Pabuç Vidası Clamp Screw Klemmschraube	Altlık Shim Unterlage	Altlık Vidası Shim Screw Schraube für Unterlage	Segman Ring Feder	Pul Stamp Ring	Anahtar Allen Key Innerschraubschlüssel
A32T TCKNR 16	●	●	32	30	300	22	≥40	CN.. 1606..	ATK-04	AKV-19-M7x25	AACN-3-0002	AAV-05-M6x15	AS-02	ABPL-02	AAL-05-4
A40U TCKNR 16	○	●	40	37.5	350	27	≥50								

KAPR=95°

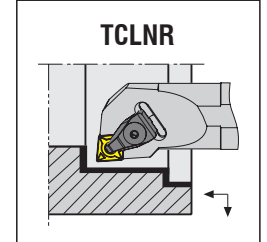
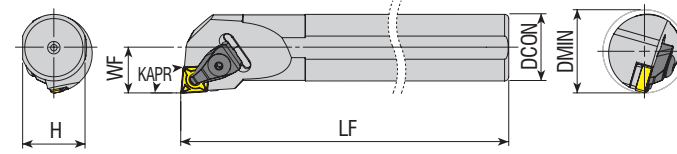

Takım Kodu Ordering Code Bestell-Bezeichnung	Stok Stock Lager		Takım Ölçüleri (mm) Dimension (mm) Abmessung (mm)					Kesici Uç Insert Wendeschneidplatte	Yedek Parçaları / Spare Parts / Ersatzteile						
	R	L	DCON	H	LF	WF	DMIN		Baskı Pabucu Wedge Clamp Spannpratze	Pabuç Vidası Clamp Screw Klemmschraube	Altlık Shim Unterlage	Altlık Vidası Shim Screw Schraube für Unterlage	Segman Ring Feder	Pul Stamp Ring	Anahtar Allen Key Innerschraubschlüssel
S25S TCLNR/L 09	●	●	25	23	250	17	≥32	CN.. 0903..	ATK-01	AKV-01-M5x22	AACN-2-0001	AAV-09-M5x9	-		
S25S TCLNR/L 12	●	●	25	23	250	17	≥32					AAV-13-M5x8			
S32T TCLNR/L 12	●	●	32	30	300	22	≥40	CN.. 1204..	ATK-02	AKV-30-M6x22	AACN-3-0001	AAV-02-M5x12	AS-01	ABPL-01	AAL-03-3
S40U TCLNR/L 12	●	●	40	37.5	350	27	≥50								
S50V TCLNR/L 12	●	●	50	47	400	35	≥63	CN.. 1606..	ATK-04	AKV-19-M7x25	AACN-3-0002	AAV-05-M6x15	AS-02	ABPL-02	AAL-05-4
S32T TCLNR/L 16	●	●	32	30	300	22	≥40								
S40U TCLNR/L 16	●	●	40	37.5	350	27	≥50	CN.. 1204..	ATK-02	AKV-30-M6x22	AACN-3-0001	AAV-13-M5x8	AS-01	ABPL-01	AAL-03-3
S50V TCLNR/L 16	●	●	50	47	400	35	≥63					AAV-02-M5x12			
A25R TCLNR/L 12	●	○	25	23	200	17	≥32	CN.. 1204..	ATK-02	AKV-30-M6x22	AACN-3-0001	AAV-02-M5x12	AS-01	ABPL-01	AAL-03-3
A40T TCLNR/L 12	●	○	40	37.5	300	27	≥50								
A50V TCLNR/L 12	○	●	50	47	400	35	≥63								

R: Sağ / Right / Rechts L: Sol / Left / Links

● Stokta / In Stock / Auf Lager ○ Stokta Yok / Non Stock Item / Kein Lagerartikel, Lieferzeit auf Anfrage

Sipariş Örneği/Ordering Example/Bestellbeispiel

1 ad./pcs./stück A32T TCKNR 16

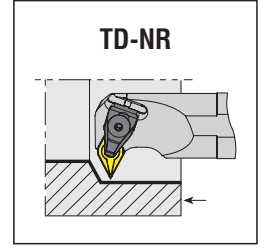
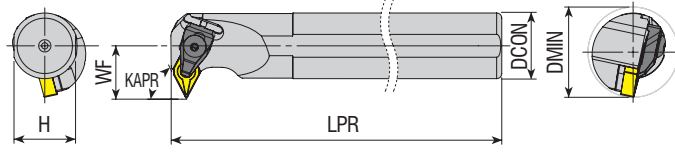

Takım Kodu Ordering Code Bestell-Bezeichnung	Stok Stock Lager		Takım Ölçüleri (mm) Dimension (mm) Abmessung (mm)					Kesici Uç Insert Wendeschneidplatte	Baskı Pabucu Wedge Clamp Spannpratze	Pabuç Vidası Clamp Screw Klemmschraube	Altlık Shim Unterlage	Altlık Vidası Shim Screw Schraube für Unterlage	Segman Ring Feder	Pul Stamp Ring	Anahtar Allen Key Innenschraubenschlüssel
	R	L	DCON	H	LPR	WF	DMIN								
S32T TD-NR/L 15	●	●	32	30	300	26	≥44	DN.. 1506..	ATK-02	AKV-30-M6x22	AADN-3-0001	AAV-02-M5x12	AS-01	ABPL-01	AAL-03-3
S40U TD-NR/L 15	●	●	40	37.5	350	29	≥52								
S50V TD-NR/L 15	●	●	50	47	400	35	≥63								

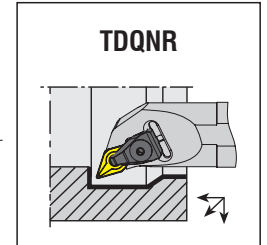
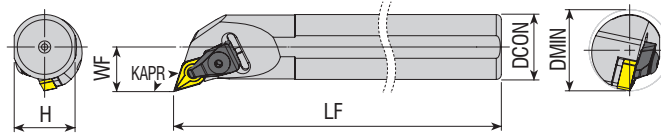

Takım Kodu Ordering Code Bestell-Bezeichnung	Stok Stock Lager		Takım Ölçüleri (mm) Dimension (mm) Abmessung (mm)					Kesici Uç Insert Wendeschneidplatte	Baskı Pabucu Wedge Clamp Spannpratze	Pabuç Vidası Clamp Screw Klemmschraube	Altlık Shim Unterlage	Altlık Vidası Shim Screw Schraube für Unterlage	Segman Ring Feder	Pul Stamp Ring	Anahtar Allen Key Innenschraubenschlüssel
	R	L	DCON	H	LF	WF	DMIN								
S25S TDQNR/L 11	●	●	25	23	250	17	≥32	DN.. 1104..	ATK-01	AKV-01-M5x22	AADN-2-0001	AAV-09-M5x9	-		
S32T TDQNR/L 11	●	●	32	30	300	22	≥40					AAV-04-M5x12			
S25S TDQNR/L 15	●	●	25	23	250	17	≥32	DN.. 1506..	ATK-02	AKV-30-M6x22	AADN-3-0001	AAV-13-M5x8	AS-01	ABPL-01	AAL-03-3
S32T TDQNR/L 15	●	●	32	30	300	22	≥40								
S40U TDQNR/L 15	●	●	40	37.5	350	27	≥50								
S50V TDQNR/L 15	●	●	50	47	400	35	≥63								

R: Sağ / Right / Rechts L: Sol / Left / Links

● Stokta / In Stock / Auf Lager ○ Stokta Yok / Non Stock Item / Kein Lagerartikel, Lieferzeit auf Anfrage

Sipariş Örneği/Ordering Example/Bestellbeispiel
1 ad./pcs./stück S32T TD-NR 15

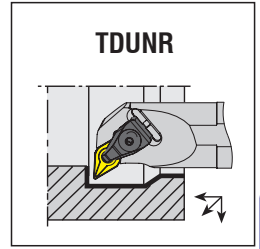
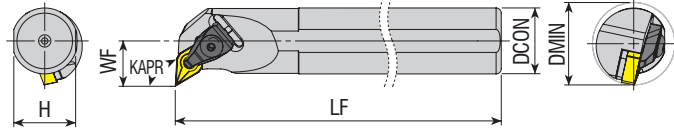

Takım Kodu Ordering Code Bestell-Bezeichnung	Stok Stock Lager		Takım Ölçüleri (mm) Dimension (mm) Abmessung (mm)				Kesici Uç Insert Wendeschneidplatte	Baskı Pabucu Wedge Clamp Spannpratze	Pabuç Vidası Clamp Screw Klemmschraube	Altlık Shim Unterlage	Altlık Vidası Shim Screw Schraube für Unterlage	Segman Ring Feder	Pul Stamp Ring	Anahtar Allen Key Innenschlitzschlüssel	
	R	L	DCON	H	LF	WF									DMIN
S25S TDUNR/L 11	●	●	25	23	250	17	≥32	DN.. 1104..	ATK-01	AKV-01-M5x22	AADN-2-0001	AAV-09-M5x9	-	ABPL-01	AAL-03-3
S32T TDUNR/L 11	●	●	32	30	300	22	≥40								
S25S TDUNR/L 15	●	●	25	23	250	17	≥34								
S32T TDUNR/L 15	●	●	32	30	300	22	≥40								
S40U TDUNR/L 15	●	●	40	37.5	350	27	≥50								
S50V TDUNR/L 15	●	●	50	47	400	35	≥63								
A40T TDUNR/L 15	●	●	40	37.5	300	27	≥50								

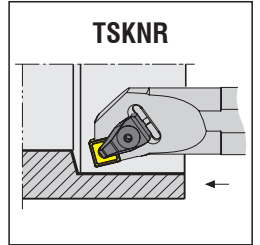
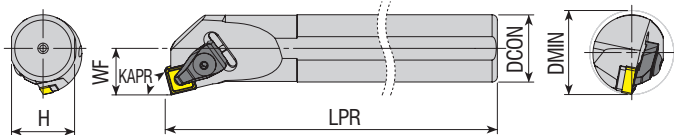

Takım Kodu Ordering Code Bestell-Bezeichnung	Stok Stock Lager		Takım Ölçüleri (mm) Dimension (mm) Abmessung (mm)				Kesici Uç Insert Wendeschneidplatte	Baskı Pabucu Wedge Clamp Spannpratze	Pabuç Vidası Clamp Screw Klemmschraube	Altlık Shim Unterlage	Altlık Vidası Shim Screw Schraube für Unterlage	Segman Ring Feder	Pul Stamp Ring	Anahtar Allen Key Innenschlitzschlüssel	
	R	L	DCON	H	LPR	WF									DMIN
S25S TSKNR/L 12	●	●	25	23	250	17	≥32	SN.. 1204..	ATK-02	AKV-30-M6x22	AASN-3-0004	AAV-13-M5x8	AS-01	ABPL-01	AAL-03-3
S32T TSKNR/L 12	●	●	32	30	300	22	≥40								
S40U TSKNR/L 12	●	●	40	37.5	350	27	≥50								

R: Sağ / Right / Rechts L: Sol / Left / Links

● Stokta / In Stock / Auf Lager ○ Stokta Yok / Non Stock Item / Kein Lagerartikel, Lieferzeit auf Anfrage

Sipariş Örneği/Ordering Example/Bestellbeispiel

1 ad./pcs./stück S25S TDUNR 11

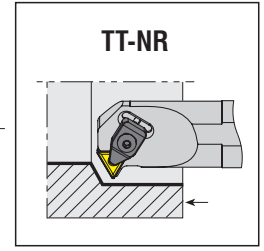
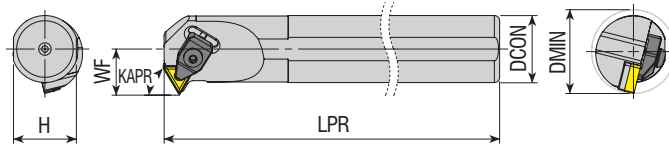

Takım Kodu Ordering Code Bestell-Bezeichnung	Stok Stock Lager		Takım Ölçüleri (mm) Dimension (mm) Abmessung (mm)					Kesici Uç Insert Wendeschneidplatte	Yedek Parçaları / Spare Parts / Ersatzteile						
	R	L	DCON	H	LPR	WF	DMIN		Baskı Pabucu Wedge Clamp Spannpratze	Pabuç Vidası Clamp Screw Klemmschraube	Altlık Shim Unterlage	Altlık Vidası Shim Screw Schraube für Unterlage	Yay Spring Пружина	Pul Stamp Ring	Anahtar Allen Key Innerschraubschlüssel
S25S TT-NR/L 16	●	●	25	23	250	17	≥32	TN.. 1604..	ATK-01	AKV-01-M5x22	AATN-2-0002	AAV-03-M5x12	-	ABPL-01	AAL-03-3
S32T TT-NR/L 16	●	●	32	30	300	22	≥40								

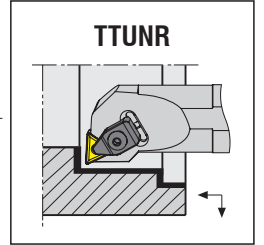
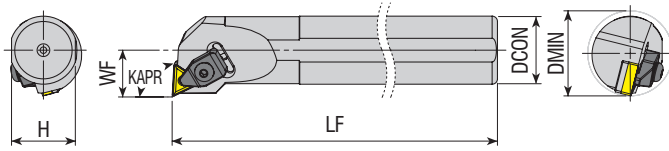
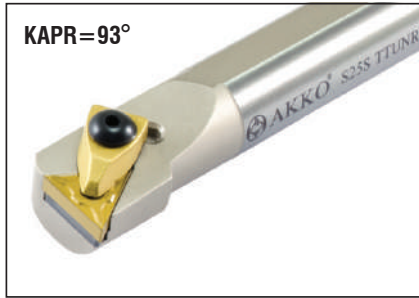

Takım Kodu Ordering Code Bestell-Bezeichnung	Stok Stock Lager		Takım Ölçüleri (mm) Dimension (mm) Abmessung (mm)					Kesici Uç Insert Wendeschneidplatte	Yedek Parçaları / Spare Parts / Ersatzteile						
	R	L	DCON	H	LF	WF	DMIN		Baskı Pabucu Wedge Clamp Spannpratze	Pabuç Vidası Clamp Screw Klemmschraube	Altlık Shim Unterlage	Altlık Vidası Shim Screw Schraube für Unterlage	Segman Ring Feder	Pul Stamp Ring	Anahtar Allen Key Innerschraubschlüssel
S25S TTUNR/L 16	●	●	25	23	250	17	≥32	TN.. 1604..	ATK-01	AKV-01-M5x22	AATN-2-0002	AAV-03-M5x12	-	ABPL-01	AAL-03-3
S32T TTUNR/L 16	●	●	32	30	300	22	≥40								
S25S TTUNR/L 22	●	●	25	23	250	17	≥32	TN.. 2204..	ATK-02	AKV-30-M6x22	AATN-3-0015	AAV-02-M5x12	AS-01	ABPL-01	AAL-03-3
S32T TTUNR/L 22	●	●	32	30	300	22	≥40								
S40U TTUNR/L 22	●	●	40	37.5	350	27	≥50								
S50V TTUNR/L 22	●	●	50	47	400	35	≥63								

R: Sağ / Right / Rechts L: Sol / Left / Links

● Stokta / In Stock / Auf Lager ○ Stokta Yok / Non Stock Item / Kein Lagerartikel, Lieferzeit auf Anfrage

Sipariş Örneği/Ordering Example/Bestellbeispiel

1 ad./pcs./stück S25S TT-NR 16

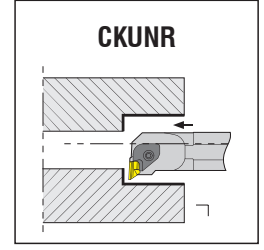
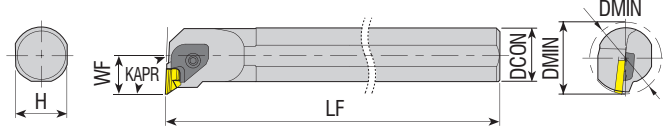

Takım Kodu Ordering Code Bestell-Bezeichnung	Stok Stock Lager		Takım Ölçüleri (mm) Dimension (mm) Abmessung (mm)					Kesici Uç Insert Wendeschneidplatte	Yedek Parçaları / Spare Parts / Ersatzteile						
	R	L	DCON	H	LF	WF	DMIN		Baskı Pabucu Wedge Clamp Spannpratze	Pabuç Vidası Clamp Screw Klemmschraube	Altlık Shim Unterlage	Altlık Vidası Shim Screw Schraube für Unterlage	Yay Spring Пружина	Pul Stamp Ring	Anahtar Allen Key Innensechskantschlüssel
	●	○													
S25S CKUNR/L 16	●	●	25	23	250	19	≥38	KNUX 1604..							
S32T CKUNR/L 16	●	●	32	30	300	22	≥40								
S40U CKUNR/L 16	●	●	40	37.5	350	27	≥50								
S50V CKUNR/L 16	●	●	50	47	400	35	≥63								

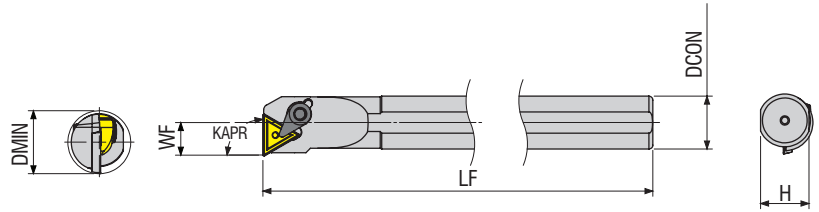

Takım Kodu Ordering Code Bestell-Bezeichnung	Stok Stock Lager		Takım Ölçüleri (mm) Dimension (mm) Abmessung (mm)					Kesici Uç Insert Wendeschneidplatte	Yedek Parçaları / Spare Parts / Ersatzteile						
	R	L	DCON	H	LF	WF	DMIN		Baskı Pabucu Wedge Clamp Spannpratze	Pabuç Vidası Clamp Screw Klemmschraube	Altlık Shim Unterlage	Altlık Vidası Shim Screw Schraube für Unterlage	Segman Ring Feder	Pul Stamp Ring	Anahtar Allen Key Innensechskantschlüssel
	●	○													
S16R CTFPR/L 16	●	○	16	14.7	200	11	22	TP. 1603..							
S20S CTFPR/L 16	●	○	20	18.3	250	13	24								
S25T CTFPR/L 16	●	○	25	23	300	17	32								

R: Sağ / Right / Rechts L: Sol / Left / Links

● Stokta / In Stock / Auf Lager ○ Stokta Yok / Non Stock Item / Kein Lagerartikel, Lieferzeit auf Anfrage

Sipariş Örneği/Ordering Example/Bestellbeispiel

1 ad./pcs./stück S25S CKUNR 16

M-SİSTEM

M-SİSTEM DELİK TORNA KATERLERİ
M-SYSTEM BORING BARS
M-SYSTEM BOHRSTANGE

*konusulan
the spoken kalite...
quality...*



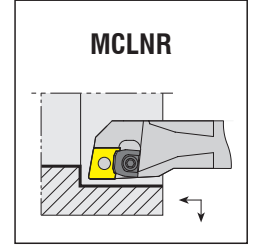
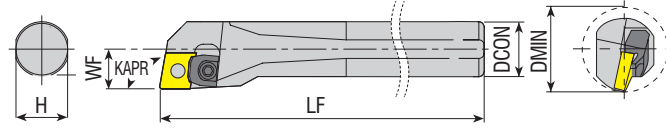

Takım Kodu
Ordering Code
Bestell-Bezeichnung

Stok Stock Lager	Takım Ölçüleri (mm) Dimension (mm) Abmessung (mm)						Kesici Uç Insert Wendeschneidplatte	Baskı Pabucu Wedge Clamp Spannpratze	Pabuç Vidası Clamp Screw Klemmschraube	Altlık Shim Unterlage	Pim Pin Stift	Pul Stamp Ring	Anahtar Allen Key Innensechskantschlüssel	
	R	L	DCON	H	LF	WF								DMIN
	●	●	20	18.3	200	13	≥25	CN.. 1204..	AMK-07		-	APM-12	-	AAL-03-3
	●	●	25	23	250	17	≥32		AMK-03	AKV-04-M5x17	AACN-3-0001	APM-13		
	●	●	32	30	300	22	≥40					APM-04		

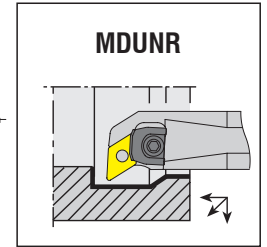
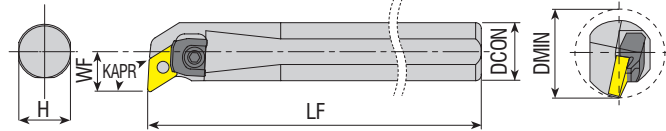

Takım Kodu
Ordering Code
Bestell-Bezeichnung

Stok Stock Lager	Takım Ölçüleri (mm) Dimension (mm) Abmessung (mm)						Kesici Uç Insert Wendeschneidplatte	Baskı Pabucu Wedge Clamp Spannpratze	Pabuç Vidası Clamp Screw Klemmschraube	Altlık Shim Unterlage	Pim Pin Stift	Segman Ring Feder	Pul Stamp Ring	Anahtar Allen Key Innensechskantschlüssel	
	R	L	DCON	H	LF	WF									DMIN
	●	●	20	18.3	200	13	≥25	DN.. 1104..						AAL-03-3	
	●	●	25	23	250	17	≥32		AMK-03	AKV-17-M5x15		APM-03	-		-
	○	○	32	30	300	22	≥40			AKV-04-M5x17	-				
	●	●	25	23	250	17	≥32	DN.. 1506..						AAL-03-3	
	●	●	32	30	300	22	≥40			AKV-20-M6x19					
	●	●	40	37.5	350	27	≥50		AMK-04	AKV-30-M6x22	AADN-3-0001	APM-04	AS-01		ABPL-01
	●	●	50	47	400	35	≥63								

R: Sağ / Right / Rechts L: Sol / Left / Links

● Stokta / In Stock / Auf Lager ○ Stokta Yok / Non Stock Item / Kein Lagerartikel, Lieferzeit auf Anfrage

Sipariş Örneği/Ordering Example/Bestellbeispiel

1 ad./pcs./stück S20R MCLNR 12

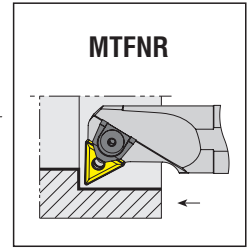
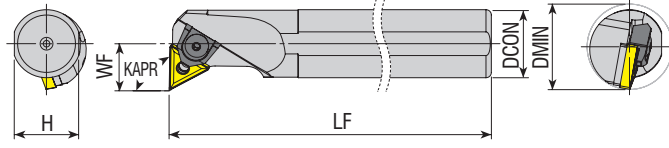

Takım Kodu Ordering Code Bestell-Bezeichnung	Takım Ölçüleri (mm) Dimension (mm) Abmessung (mm)							Kesici Uç Insert Wendeschneidplatte	Baskı Pabucu Wedge Clamp Spannpratze	Pabuç Vidası Clamp Screw Klemmschraube	Altlık Shim Unterlage	Pim Pin Stift	Segman Ring Feder	Pul Stamp Ring	Anahtar Allen Key Innensechskantschlüssel		
	Stok Stock Lager		R	L	DCON	H	LF									WF	DMIN
	R	L	DCON	H	LF	WF	DMIN										
S20R MTFNR/L 16	●	●	20	18.3	200	14	≥25	TN.. 1604..	AMK-02	AKV-17-M5x15	-	APM-03	-	-	ABPL-01 AAL-03-3		
S25S MTFNR/L 16	●	●	25	23	250	17	≥32		AMK-04	AKV-30-M6x22	AATN-2-0002	APM-14	AS-01				
S32T MTFNR/L 16	●	●	32	30	300	22	≥40				AMK-04	AKV-30-M6x22		AATN-2-0002		APM-01	
S40U MTFNR/L 16	●	●	40	37.5	350	27	≥50		AMK-08	AKV-30-M6x22			AATN-3-0015	APM-02			
S32T MTFNR/L 22	●	●	32	30	300	22	≥40	TN.. 2204..			AMK-08	AKV-30-M6x22	AATN-3-0015	APM-02			
S40U MTFNR/L 22	●	●	40	37.5	350	27	≥50										
S50V MTFNR/L 22	●	○	50	47	400	35	≥63										

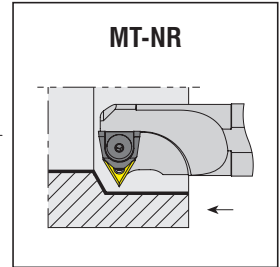
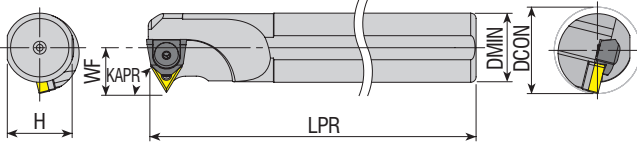

Takım Kodu Ordering Code Bestell-Bezeichnung	Takım Ölçüleri (mm) Dimension (mm) Abmessung (mm)							Kesici Uç Insert Wendeschneidplatte	Baskı Pabucu Wedge Clamp Spannpratze	Pabuç Vidası Clamp Screw Klemmschraube	Altlık Shim Unterlage	Pim Pin Stift	Segman Ring Feder	Pul Stamp Ring	Anahtar Allen Key Innensechskantschlüssel		
	Stok Stock Lager		R	L	DCON	H	LPR									WF	DMIN
	R	L	DCON	H	LPR	WF	DMIN										
S20R MT-NR/L 16	●	●	20	18.3	200	16	≥26	TN.. 1604..	AMK-02	AKV-04-M5x17	-	APM-03	-	-	ABPL-01 AAL-03-3		
S25S MT-NR/L 16	●	●	25	23	250	17	≥32		AMK-04	AKV-30-M6x22	AATN-2-0002	APM-14	AS-01				
S32T MT-NR/L 16	●	●	32	30	300	22	≥40				AMK-04	AKV-30-M6x22		AATN-2-0002		APM-01	
S40U MT-NR/L 16	●	●	40	37.5	350	27	≥50		AMK-08	AKV-30-M6x22			AATN-3-0015	APM-02			
S32T MT-NR/L 22	●	●	32	30	300	24	≥40	TN.. 2204..			AMK-08	AKV-30-M6x22	AATN-3-0015	APM-02			
S40U MT-NR/L 22	●	●	40	37.5	350	27	≥50										
S50U MT-NR/L 22	●	●	50	47	350	35	≥63										

R: Sağ / Right / Rechts L: Sol / Left / Links
● Stokta / In Stock / Auf Lager ○ Stokta Yok / Non Stock Item / Kein Lagerartikel, Lieferzeit auf Anfrage

Sipariş Örneği/Ordering Example/Bestellbeispiel
1 ad./pcs./stück S20R MTFNR 16

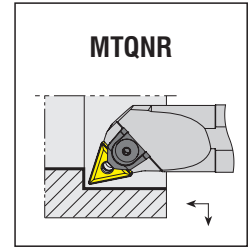
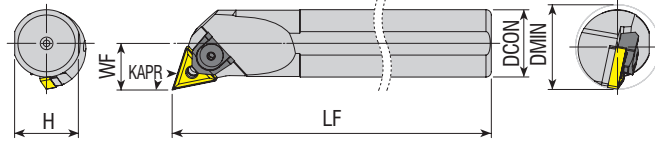

Takım Kodu
Ordering Code
Bestell-Bezeichnung

Stok Stock Lager	Takım Ölçüleri (mm) Dimension (mm) Abmessung (mm)						Kesici Uç Insert Wendeschneidplatte	Baskı Pabucu Wedge Clamp Spannpratze	Pabuç Vidası Clamp Screw Klemmschraube	Altılık Shim Unterlage	Pim Pin Stift	Segman Ring Feder	Pul Stamp Ring	Anahtar Allen Key Innensechskantschlüssel
	R	L	DCON	H	LF	WF								
							TN.. 1604..	AMK-02	AKV-17-M5x15	-	APM-11	-	-	
								AMK-04		AATN-2-0002	APM-14			
											APM-01			
									AKV-30-M6x22			AS-01	ABPL-01	AAL-03-3
							TN.. 2204..	AMK-08		AATN-3-0015	APM-02			

Yedek Parçaları / Spare Parts / Ersatzteile

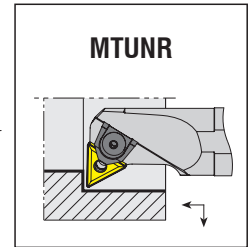
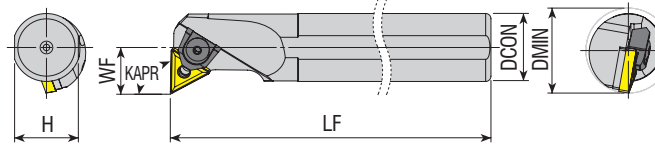

Takım Kodu
Ordering Code
Bestell-Bezeichnung

Stok Stock Lager	Takım Ölçüleri (mm) Dimension (mm) Abmessung (mm)						Kesici Uç Insert Wendeschneidplatte	Baskı Pabucu Wedge Clamp Spannpratze	Pabuç Vidası Clamp Screw Klemmschraube	Altılık Shim Unterlage	Pim Pin Stift	Segman Ring Feder	Pul Stamp Ring	Anahtar Allen Key Innensechskantschlüssel
	R	L	DCON	H	LF	WF								
							TN.. 1604..	AMK-02	AKV-17-M5x15	-	APM-03	-	-	
								AMK-04		AATN-2-0002	APM-14			
											APM-01			
									AKV-30-M6x22			AS-01	ABPL-01	AAL-03-3
							TN.. 2204..	AMK-08		AATN-3-0015	APM-02			

Yedek Parçaları / Spare Parts / Ersatzteile

R: Sağ / Right / Rechts L: Sol / Left / Links

● Stokta / In Stock / Auf Lager ○ Stokta Yok / Non Stock Item / Kein Lagerartikel, Lieferzeit auf Anfrage

Sipariş Örneği/Ordering Example/Bestellbeispiel

1 ad./pcs./stück S20R MTQNR 16

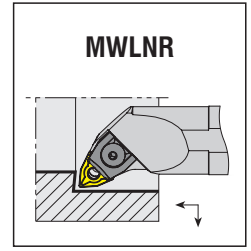
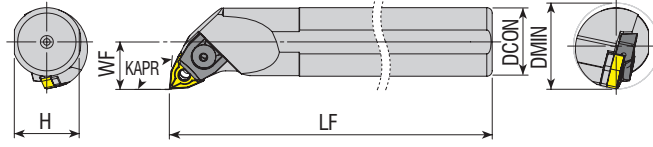

Takım Kodu
Ordering Code
Bestell-Bezeichnung

Stok Stock Lager	Takım Ölçüleri (mm) Dimension (mm) Abmessung (mm)						Kesici Uç Insert Wendeschneidplatte	Baskı Pabucu Wedge Clamp Spannpratze	Pabuç Vidası Clamp Screw Klemmschraube	Yedek Parçaları / Spare Parts / Ersatzteile						
	R	L	DCON	H	LF	WF				DMIN	Altık Shim Unterlage	Pim Pin Stift	Segman Ring Feder	Pul Stamp Ring	Anahtar Allen Key Innensechskantschlüssel	
			16	14.8	170	11	≥23	WN.. 0604..	AMK-01	AKV-17-M5x15 AKV-04-M5x17	-	APM-09	-	-	-	-
			20	18.3	200	13	≥25					APM-10				
			25	23	250	17	≥32					APM-08				
			20	18.3	200	13	≥25	WN.. 0804..	ACK-05	4015-M4X11 AKV-27-M6x20	-	AEV-02-M6X13	-	-	-	AAL-02-2.5
			25	23	250	17	≥32					APM-04				
			32	30	300	22	≥40					AMK-05				
			40	37.5	350	27	≥50					APM-02	AS-01	ABPL-01	AAL-03-3	

R: Sağ / Right / Rechts L: Sol / Left / Links
● Stokta / In Stock / Auf Lager ○ Stokta Yok / Non Stock Item / Kein Lagerartikel, Lieferzeit auf Anfrage

Sipariş Örneği/Ordering Example/Bestellbeispiel
1 ad./pcs./stück S16P MWLNR 06





*konusulan
the spoken kalite...
quality...*

P-SİSTEM

P-SİSTEM DELİK TORNA KATERLERİ
P-SYSTEM BORING BARS
P-SYSTEM BOHRSTANGE



www.akkо.com.tr

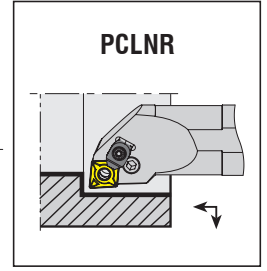
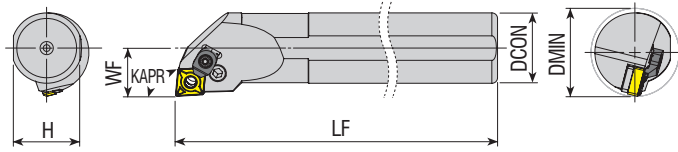

Takım Kodu Ordering Code Bestell-Bezeichnung	Stok Stock Lager		Takım Ölçüleri (mm) Dimension (mm) Abmessung (mm)					Kesici Uç Insert Wendeschneidplatte	Yedek Parçaları / Spare Parts / Ersatzteile						
	R	L	DCON	H	LF	WF	DMIN		Levyeye Lever Kniehebel	Levyeye Vidası Lever Screw Kniehebelschraube	Altılık Shim Unterlage	Altılık Yay Shim Spring Feder für Unterlage	Baskı Pabuç Wedge Clamp Spannpratze	Pabuç Vidası Clamp Screw Klemmschraube	Anahtar Allen Key Innenschlüssel
	●	○													
S16P PCLNR/L 09	●	●	16	14.8	170	11	≥20	CN.. 0903..	APL-07	ALV-07-M6x13	-	AAV-07	-	-	AAL-02-2.5
S20R PCLNR/L 09	●	●	20	18.3	200	13	≥25		APL-01	ALV-01-M6x14 ALV-02-M6x17	AACN-2-0002	AAV-01	-	-	AAL-02-2.5
S25S PCLNR/L 09	●	○	25	23	250	17	≥32			ALV-08-M8x16					
S25S PCLNR/L 12C	●	●	25	23	250	17	≥32	CN.. 1204..	APL-02	ALV-03-M8x19	AACN-3-0001	AAV-02	ACK-05	4015-M4x11	AAL-03-3
S32T PCLNR/L 12C	●	●	32	30	300	22	≥40								
S40U PCLNR/L 12C	●	●	40	37.5	350	27	≥50								
S50V PCLNR/L 12C	●	●	50	47	400	35	≥63								
S32T PCLNR/L 16C	●	●	32	30	300	22	≥40	CN.. 1606..	APL-04	ALV-04-M8x22	AACN-3-0002	AAV-03	ACK-09	AAV-05-M6x15	
S40U PCLNR/L 16C	●	●	40	37.5	350	27	≥50								
S50V PCLNR/L 16C	●	●	50	47	400	35	≥63								
S40U PCLNR/L 19C	●	●	40	37.5	350	27	≥50	CN.. 1906..	APL-05	ALV-05-M10x27	AACN-3-0003	AAV-04	ACK-09	AAV-05-M6x15	AAL-05-4
S50V PCLNR/L 19C	●	●	50	47	400	35	≥63								
A16R PCLNR/L 09	●	○	16	14.8	200	11	≥20		CN.. 0903..	APL-01	ALV-08-M8x16 ALV-01-M6x17	AACN-2-0002	AAV-01	-	-
A20P PCLNR/L 09	●	●	20	18.3	170	13	≥25								
A25R PCLNR/L 12C	●	●	25	23	200	17	≥32								
A25S PCLNR/L 12C	●	○	25	23	250	17	≥32	CN.. 1204..	APL-02	ALV-03-M8x19	AACN-3-0001	AAV-02	ACK-05	4015-M4x11	AAL-03-3
A32S PCLNR/L 12C	●	●	32	30	250	22	≥40								
A32T PCLNR/L 12C	○	●	32	30	300	22	≥40								
A40T PCLNR/L 12C	●	●	40	37.5	300	27	≥50	CN.. 1606..	APL-04	ALV-04-M8x22	AACN-3-0002	AAV-03	ACK-09	AAV-05-M6x15	
A50U PCLNR/L 12C	●	●	50	47	350	35	≥63								
A32S PCLNR/L 16C	●	●	32	30	250	22	≥40								
A40T PCLNR/L 16C	●	●	40	37.5	300	27	≥50	CN.. 1906..	APL-05	ALV-05-M10x27	AACN-3-0003	AAV-04	ACK-09	AAV-05-M6x15	AAL-05-4
A50U PCLNR/L 16C	●	●	50	47	350	35	≥63								
A40T PCLNR/L 19C	●	●	40	37.5	300	27	≥50								
A50U PCLNR/L 19C	●	●	50	47	350	35	≥63								

R: Sağ / Right / Rechts L: Sol / Left / Links
● Stokta / In Stock / Auf Lager ○ Stokta Yok / Non Stock Item / Kein Lagerartikel, Lieferzeit auf Anfrage

Sipariş Örneği/Ordering Example/Bestellbeispiel
1 ad./pcs./stück S16P PCLNR 09

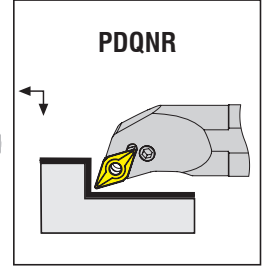
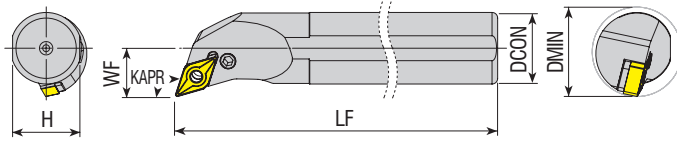

Takım Kodu Ordering Code Bestell-Bezeichnung	Stok Stock Lager		Takım Ölçüleri (mm) Dimension (mm) Abmessung (mm)					Kesici Uç Insert Wendeschneidplatte	Levye Lever Kniehebel	Levye Vidası Lever Screw Kniehebelschraube	Yedek Parçaları / Spare Parts / Ersatzteile					
	R	L	DCON	H	LF	WF	DMIN				Altık Shim Unterlage	Altık Yayı Shim Spring Feder für Unterlage	Baskı Pabucu Wedge Clamp Spannpratze	Pabuç Vidası Clamp Screw Klemmschraube	Anahtar Allen Key Innensechskantschlüssel	
S20R PDQNR/L 11	●	○	20	18.3	200	13	≥25	DN.. 1104..	APL-01	ALV-01-M6x14 ALV-02-M6x17	AADN-SD317	AAY-01				AAL-02-2.5
S25S PDQNR/L 11	●	●	25	23	250	17	≥32									
S32T PDQNR/L 15	●	●	32	30	300	22	≥40	DN.. 1506..	APL-03	ALV-03-M8x19	AADN-3-0001	AAY-02	-	-	AAL-03-3	
S40U PDQNR/L 15	●	●	40	37.5	350	27	≥50									
S50V PDQNR/L 15	●	●	50	47	400	35	≥63	DN.. 1504..	APL-03	ALV-03-M8x19	AADN-2-0003	AAY-02	-	-	AAL-03-3	
S32T PDQNR/L 1504	●	●	32	30	300	22	≥40									
S40U PDQNR/L 1504	●	●	40	37.5	350	27	≥50	DN.. 1504..	APL-03	ALV-03-M8x19	AADN-2-0003	AAY-02	-	-	AAL-03-3	
S50V PDQNR/L 1504	●	●	50	47	400	35	≥63									
A20P PDQNR/L 11	●	●	20	18.3	170	13	≥25	DN.. 1104..	APL-01	ALV-01-M6x14 ALV-02-M6x17	AADN-SD317	AAY-01	-	-	AAL-02-2.5	
A25R PDQNR/L 11	●	●	25	23	200	17	≥32									
A32S PDQNR/L 15	●	●	32	30	250	22	≥40	DN.. 1506..	APL-03	ALV-03-M8x19	AADN-3-0001	AAY-02	-	-	AAL-03-3	
A40T PDQNR/L 15	●	●	40	37.5	300	27	≥50									
A50U PDQNR/L 15	●	●	50	47	350	35	≥63	DN.. 1504..	APL-03	ALV-03-M8x19	AADN-2-0003	AAY-02	-	-	AAL-03-3	
A32S PDQNR/L 1504	●	●	32	30	250	22	≥40									
A40T PDQNR/L 1504	●	●	40	37.5	300	27	≥50									

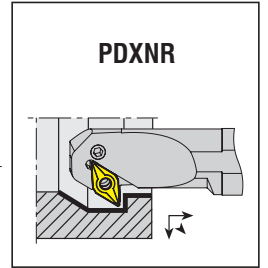
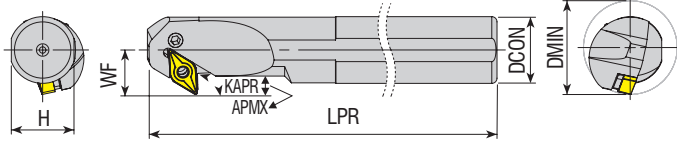

Takım Kodu Ordering Code Bestell-Bezeichnung	Stok Stock Lager		Takım Ölçüleri (mm) Dimension (mm) Abmessung (mm)						Kesici Uç Insert Wendeschneidplatte	Levye Lever Kniehebel	Levye Vidası Lever Screw Kniehebelschraube	Yedek Parçaları / Spare Parts / Ersatzteile					
	R	L	DCON	H	LPR	WF	APMX	DMIN				Altık Shim Unterlage	Altık Yayı Shim Spring Feder für Unterlage	Baskı Pabucu Wedge Clamp Spannpratze	Pabuç Vidası Clamp Screw Klemmschraube	Anahtar Allen Key Innensechskantschlüssel	
S32T PDXNR/L 15	●	●	32	30	300	22	12	≥45	DN.. 1506..	APL-03	ALV-08-M8x16 ALV-03-M8x19 ALV-08-M8x16 ALV-03-M8x19	AADN-3-0001	AAY-02	-	-	AAL-03-3	
S40U PDXNR/L 15	●	●	40	37.5	350	27	14	≥50									
S50V PDXNR/L 15	●	●	50	47	400	35	19	≥63									
A32S PDXNR/L 15	●	●	32	30	250	22	12	≥40									
A40T PDXNR/L 15	●	●	40	37.5	300	27	14	≥50									
A50U PDXNR/L 15	●	●	50	47	350	35	19	≥63									

R: Sağ / Right / Rechts L: Sol / Left / Links

● Stokta / In Stock / Auf Lager ○ Stokta Yok / Non Stock Item / Kein Lagerartikel, Lieferzeit auf Anfrage

Not: "APMX" ölçüleri R0.8'e göre verilmiştir. Note: Dimensions of "APMX" are given according to R0.8. Hinweis: Maß "APMX" gilt für Eckenradius 0,8 mm

Sipariş Örneği/Ordering Example/Bestellbeispiel

1 ad./pcs./stück S20R PDQNR 11

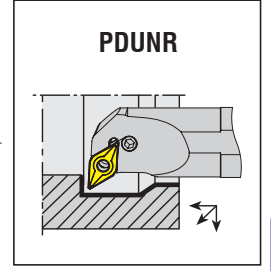
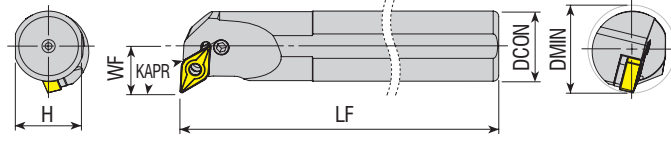
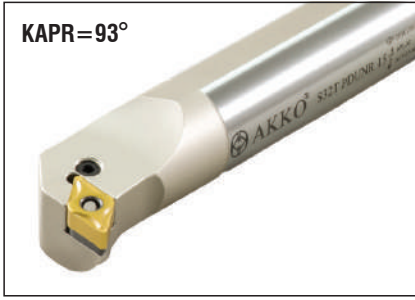

Takım Kodu Ordering Code Bestell-Bezeichnung	Stok Stock Lager		Takım Ölçüleri (mm) Dimension (mm) Abmessung (mm)				Kesici Uç Insert Wendeschneidplatte	Yedek Parçaları / Spare Parts / Ersatzteile								
	R	L	DCON	H	LF	WF		DMIN	Levy Lever Kniehebel	Levy Vidası Lever Screw Kniehebelschraube	Altık Shim Unterlage	Altık Yayı Shim Spring Feder für Unterlage	Baskı Pabucu Wedge Clamp Spannpratze	Pabuç Vidası Clamp Screw Klemmschraube	Anahtar Allen Key Innensechskantschlüssel	
S20R PDUNR/L 11	●	●	20	18.3	200	13	≥25	DN.. 1104..	APL-01	ALV-01-M6x14 ALV-02-M6x17	AADN-SD317	AAY-01	-	-	AAL-02-2.5	
S25S PDUNR/L 11	●	●	25	23	250	17	≥32									
S25S PDUNR/L 15	●	●	25	23	250	19	≥32									
S32T PDUNR/L 15	●	●	32	30	300	22	≥40	DN.. 1506..	APL-03	ALV-03-M8x19	AADN-3-0001	AAY-02	-	-	AAL-03-3	
S40U PDUNR/L 15	●	●	40	37.5	350	27	≥50									
S50V PDUNR/L 15	●	●	50	47	400	35	≥63									
A20P PDUNR/L 11	●	●	20	18.3	170	13	≥25	DN.. 1104..	APL-01	ALV-01-M6x14 ALV-02-M6x17	AADN-SD317	AAY-01	-	-	AAL-02-2.5	
A25R PDUNR/L 11	●	●	25	23	200	17	≥32									
A25S PDUNR/L 11	●	○	25	23	250	17	≥32									
A32S PDUNR/L 11	●	●	32	30	250	22	≥40	DN.. 1506..	APL-03	ALV-03-M8x19	AADN-3-0001	AAY-02	-	-	AAL-03-3	
A32S PDUNR/L 15	●	●	32	30	250	22	≥40									
A40T PDUNR/L 15	●	●	40	37.5	300	27	≥50									
A50U PDUNR/L 15	●	●	50	47	350	35	≥63									

R: Sağ / Right / Rechts L: Sol / Left / Links

● Stokta / In Stock / Auf Lager ○ Stokta Yok / Non Stock Item / Kein Lagerartikel, Lieferzeit auf Anfrage

Sipariş Örneği/Ordering Example/Bestellbeispiel

1 ad./pcs./stück S20R PDUNR 11



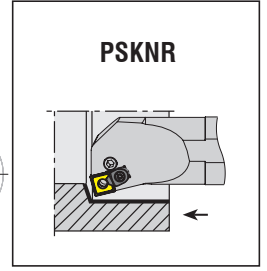
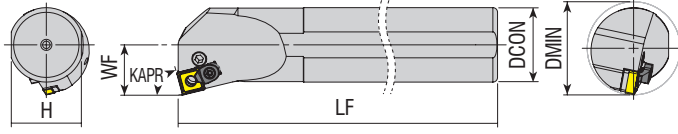

Takım Kodu Ordering Code Bestell-Bezeichnung	Stok Stock Lager		Takım Ölçüleri (mm) Dimension (mm) Abmessung (mm)				Kesici Uç Insert Wendeschneidplatte	Levyeye Lever Kniehebel	Levyeye Vidası Lever Screw Kniehebelschraube	Yedek Parçaları / Spare Parts / Ersatzteile					
	R	L	DCON	H	LF	WF				DMIN	Altılık Shim Unterlage	Altılık Yayı Shim Spring Feder für Unterlage	Baskı Pabuçu Wedge Clamp Spannpratze	Pabuç Vidası Clamp Screw Klemmschraube	Anahtar Allen Key Innensechskantschlüssel
S25S PSKNR/L 12C	●	●	25	23	250	17	≥32	SN.. 1204..	APL-02	ALV-08-M8x16	AASN-3-0004	AAY-02	ACK-05	4015-M4x11	AAL-03-3
S32T PSKNR/L 12C	●	●	32	30	300	22	≥40								
S40U PSKNR/L 12C	●	●	40	37.5	350	27	≥50								
S50V PSKNR/L 12C	●	●	50	47	400	35	≥63								
S32T PSKNR/L 15C	○	○	32	30	300	22	≥40	SN.. 1506..	APL-04	ALV-04-M8x22	AASN-3-0023	AAY-03	ACK-09	AAV-05-M6x15	
S40U PSKNR/L 15C	○	○	40	37.5	350	27	≥50								
S50V PSKNR/L 15C	○	○	50	47	400	35	≥63								
A25R PSKNR/L 12C	●	●	25	23	200	17	≥32	SN.. 1204..	APL-02	ALV-08-M8x16	AASN-3-0004	AAY-02	ACK-05	4015-M4x11	
A32S PSKNR/L 12C	●	●	32	30	250	22	≥40								
A40T PSKNR/L 12C	●	●	40	37.5	300	27	≥50								
A50U PSKNR/L 12C	○	○	50	47	350	35	≥63								
A32S PSKNR/L 15C	●	●	32	30	250	22	≥40	SN.. 1506..	APL-04	ALV-04-M8x22	AASN-3-0023	AAY-03	ACK-09	AAV-05-M6x15	
A40T PSKNR/L 15C	●	●	40	37.5	300	27	≥50								
A50U PSKNR/L 15C	●	●	50	47	350	35	≥63								

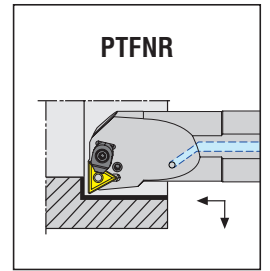
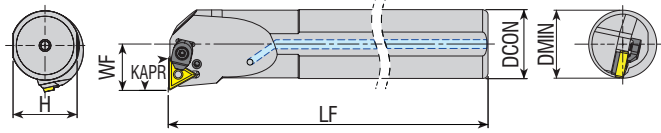

Takım Kodu Ordering Code Bestell-Bezeichnung	Stok Stock Lager		Takım Ölçüleri (mm) Dimension (mm) Abmessung (mm)				Kesici Uç Insert Wendeschneidplatte	Levyeye Lever Kniehebel	Levyeye Vidası Lever Screw Kniehebelschraube	Yedek Parçaları / Spare Parts / Ersatzteile					
	R	L	DCON	H	LF	WF				DMIN	Altılık Shim Unterlage	Altılık Yayı Shim Spring Feder für Unterlage	Baskı Pabuçu Wedge Clamp Spannpratze	Pabuç Vidası Clamp Screw Klemmschraube	Anahtar Allen Key Innensechskantschlüssel
A25R PTFNR/L 16C	●	●	25	23	200	17	≥32	TN.. 1604..	APL-01	ALV-02-M6x17	AATN-3-0025	AAY-01	ACK-05	4015-M4x11	AAL-02-2.5
A32S PTFNR/L 16C	●	●	32	30	250	22	≥40								

R: Sağ / Right / Rechts L: Sol / Left / Links

● Stokta / In Stock / Auf Lager ○ Stokta Yok / Non Stock Item / Kein Lagerartikel, Lieferzeit auf Anfrage

Sipariş Örneği/Ordering Example/Bestellbeispiel

1 ad./pcs./stück S25S PSKNR 12C

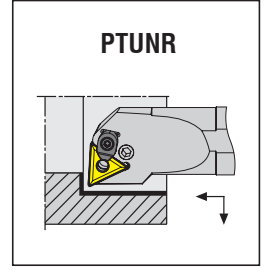
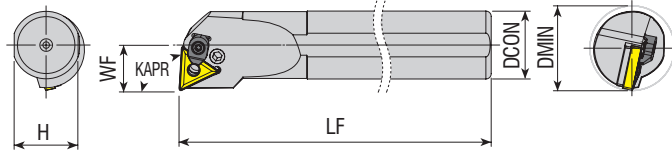

Takım Kodu Ordering Code Bestell-Bezeichnung	Stok Stock Lager		Takım Ölçüleri (mm) Dimension (mm) Abmessung (mm)					Kesici Uç Insert Wendeschneidplatte	Yedek Parçaları / Spare Parts / Ersatzteile						
	R	L	DCON	H	LF	WF	DMIN		Leve Lever Kniehebel	Leve Vidası Lever Screw Kniehebelschraube	Altlık Shim Unterlage	Altlık Yay Shim Spring Feder für Unterlage	Baskı Pabucu Wedge Clamp Spannpratze	Pabuç Vidası Clamp Screw Klemmschraube	Anahtar Allen Key Innensechskantschlüssel
S16P PTUNR/L 16	●	●	16	14.8	170	11	≥20	TN.. 1604..	APL-08	ALV-07-M6x13	-	AAY-07	-	-	AAL-02-2.5
S20R PTUNR/L 16	●	●	20	18.3	200	13	≥25		APL-01	ALV-01-M6x14					
S25S PTUNR/L 16C	●	●	25	23	250	17	≥32			ALV-02-M6x17	AATN-3-0025	AAY-01			
S32T PTUNR/L 16C	●	●	32	30	300	22	≥40								
S40U PTUNR/L 16C	●	●	40	37.5	350	27	≥50								
S32T PTUNR/L 22C	●	●	32	30	300	22	≥40	TN.. 2204..	APL-02	ALV-03-M8x19	AATN-3-0015	AAY-02	ACK-05	4015-M4x11	AAL-03-3
S40U PTUNR/L 22C	●	●	40	37.5	350	27	≥50								
S50V PTUNR/L 22C	●	●	50	47	400	35	≥63								
A16M PTUNR/L 16	●	●	16	14.8	150	11	≥20	TN.. 1604..	APL-08	ALV-07-M6x13	-	AAY-07	-	-	AAL-02-2.5
A20P PTUNR/L 16	●	●	20	18.3	170	13	≥25		APL-01	ALV-01-M6x14					
A25R PTUNR/L 16C	●	●	25	23	200	17	≥32			ALV-02-M6x17	AATN-3-0025	AAY-01			
A32S PTUNR/L 16C	●	●	32	30	250	22	≥40								
A40T PTUNR/L 16C	●	●	40	37.5	300	27	≥50								
A32S PTUNR/L 22C	●	●	32	30	250	22	≥40	TN.. 2204..	APL-02	ALV-03-M8x19	AATN-3-0015	AAY-02	ACK-05	4015-M4x11	AAL-03-3
A40T PTUNR/L 22C	●	●	40	37.5	300	27	≥50								

R: Sağ / Right / Rechts L: Sol / Left / Links

● Stokta / In Stock / Auf Lager ○ Stokta Yok / Non Stock Item / Kein Lagerartikel, Lieferzeit auf Anfrage

Sipariş Örneği/Ordering Example/Bestellbeispiel
1 ad./pcs./stück S16P PTUNR 16





*konusulan
the spoken kalite...
quality...*

S-SİSTEM

S-SİSTEM DELİK TORNA KATERLERİ
S-SYSTEM BORING BARS
S-SYSTEM BOHRSTANGE



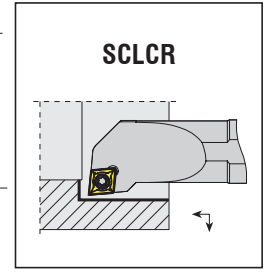
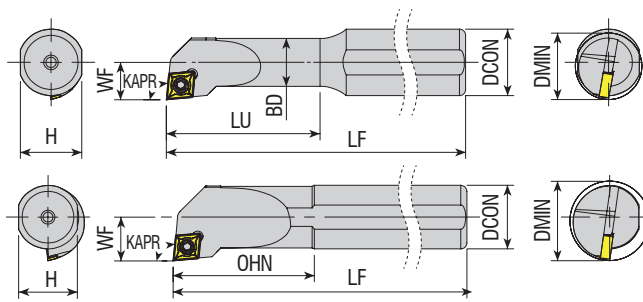

Yedek Parçaları / Spare Parts / Ersatzteile

Takım Kodu
Ordering Code
Bestell-Bezeichnung

Stok Stock Lager	Takım Ölçüleri (mm) Dimension (mm) Abmessung (mm)								Kesici Uç Insert Wendeschneidplatte	Sıkma Vidası Screw Klemmschraube	Altlık Shim Unterlage	Altlık Vidası Shim Screw Schraube für Unterlage	Tork Anahtar Torx Key Torx / Innenschlantschlüssel	
	R	L	DCON	BD	H	LU=OHN	LF	WF						DMIN
	○		08	5	7.3	18	100	3	≥6	CC.. 0301..	4006-M1.6x3.2			82-T06
	●	●	08	6	7.3	25	100	4.5	≥8	CC.. 0602..	4008-M2.5x4.5			82-T08
	●	●	08	8	7.3	20	100	06	≥11		4008-M2.5x5	-	-	
new	●	●	8	7.5	7.3	20	125	6	≥11		4008-M2.5x5			
new	●	●	8	7.5	7.3	20	150	6	≥11		4008-M2.5x6			
	●	●	10	10	09	25	125	07	≥13					
	●	●	12	12	11	25	125	09	≥16					
	●	●	16	11.5	14.8	37	170	09	≥16		4008-M2.5x6			
	●	●	16	16	14.8	35	170	11	≥20					
	●	●	12	12	11	30	125	09	≥16	4015-M3.5x8			80-T15	
new	●	●	12	11.5	11	30	150	9	≥16	4015-M3.5x9	-	-		
	●	●	16	14	14.8	45	170	9.5	≥17	CC.. 09T3..				
	●	●	16	16	14.8	35	170	11	≥20		4015-M3.5x12	AACN-2-0001		AAV-08-M3.5x8
	●	●	20	16	18.3	50	200	11	≥20					
new	●	●	16	15.5	14.8	35	200	11	≥20	4015-M3.5x9				
	●	●	20	20	18.3	40	200	13	≥25		AACN-2-0003	AAV-10-M4.5x8		
new	●	●	20	19.5	18.3	40	250	13	≥25	4015-M3.5x9				
	●	●	25	25	23	50	250	17	≥32					
	●	●	32	32	30	60	300	22	≥40					
	●	●	25	25	23	50	250	17	≥32	CC.. 1204..	4020-M4.5x12			80-T20
	●	●	32	32	30	60	300	22	≥40					
	●	●	40	40	37.5	70	350	27	≥50		1020-M4.5x16			
	●	●	08	8	7.3	20	100	06	≥11	CC.. 0602..	4008-M2.5x4.5	AACN-2-0001	AAV-08-M3.5x8	82-T08
	●	●	10	10	09	25	100	07	≥13		4008-M2.5x6			
	●	●	12	12	11	25	100	09	≥16			AACN-2-0003	AAV-10-M4.5x8	
	●	●	16	16	14.8	35	150	11	≥20	CC.. 09T3..	4015-M3.5x9			80-T15
	●	●	20	20	18.3	40	170	13	≥25					
	●	●	25	25	23	50	200	17	≥32					
	●	●	32	32	30	60	250	22	≥40		4015-M3.5x12			
	●	●	25	25	23	50	200	17	≥32		4020-M4.5x12			

R: Sağ / Right / Rechts L: Sol / Left / Links

● Stokta / In Stock / Auf Lager ○ Stokta Yok / Non Stock Item / Kein Lagerartikel, Lieferzeit auf Anfrage

Sipariş Örneği/Ordering Example/Bestellbeispiel

1 ad./pcs./stück S0508H SCLCR 03

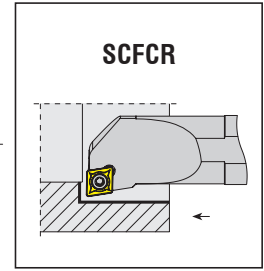
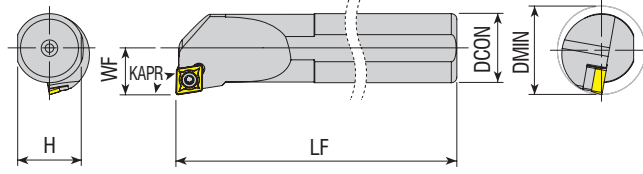

Takım Kodu Ordering Code Bestell-Bezeichnung	Stok Stock Lager		Takım Ölçüleri (mm) Dimension (mm) Abmessung (mm)				Kesici Uç Insert Wendeschneidplatte	Yedek Parçaları / Spare Parts / Ersatzteile				
	R	L	DCON	H	LF	WF		DMIN	Sıkma Vidası Screw Klemmschraube	Altlık Shim Unterlage	Altlık Vidası Shim Screw Schraube für Unterlage	Tork Anahtar Torx Key Torx Innensechskantschlüssel
S08H SCFCR/L 06	●	●	08	7.3	100	06	≥11	CC.. 0602..	4008-M2.5x6	-	-	82-T08
S10K SCFCR/L 06	●	●	10	09	125	07	≥13		4015-M3.5x8			
S12K SCFCR/L 06	●	●	12	11	125	09	≥16					
S12K SCFCR/L 09	●	●	12	11	125	09	≥16	CC.. 09T3..	4015-M3.5x9	-	-	80-T15
S16P SCFCR/L 09	●	●	16	14.8	170	11	≥20		4015-M3.5x12	AACN-2-0001	AAV-08-M3.5x8	
S20R SCFCR/L 09	●	●	20	18.3	200	13	≥25					
S25S SCFCR/L 09	●	●	25	23	250	17	≥32	CC.. 1204..	4020-M4.5x12	AACN-2-0003	AAV-10-M4.5x8	80-T20
S25S SCFCR/L 12	●	○	25	23	250	17	≥32		1020-M4.5x16			
S32T SCFCR/L 12	○	○	32	30	300	22	≥40					
S40U SCFCR/L 12	○	○	40	37.5	350	27	≥50	CC.. 0602..	4008-M2.5x6	-	-	82-T08
A08H SCFCR/L 06	●	○	08	7.3	100	06	≥11					

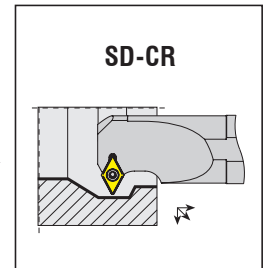
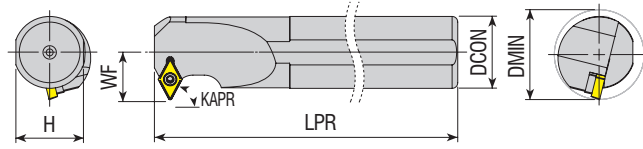

Takım Kodu Ordering Code Bestell-Bezeichnung	Stok Stock Lager		Takım Ölçüleri (mm) Dimension (mm) Abmessung (mm)				Kesici Uç Insert Wendeschneidplatte	Yedek Parçaları / Spare Parts / Ersatzteile				
	R	L	DCON	H	LPR	WF		DMIN	Sıkma Vidası Screw Klemmschraube	Altlık Shim Unterlage	Altlık Vidası Shim Screw Schraube für Unterlage	Tork Anahtar Torx Key Torx Innensechskantschlüssel
S10K SD-CR/L 07	●	●	10	9	125	08	≥14	DC.. 0702..	4008-M2.5x6	-	-	82-T08
S12K SD-CR/L 07	●	●	12	11	125	09	≥16		4015-M3.5x11	-	-	
S16P SD-CR/L 07	●	●	16	14.8	170	11	≥20					
S20R SD-CR/L 07	●	○	20	18.3	200	13	≥25	DC.. 11T3..	4015-M3.5x14	AADN-2-0001	AAV-06-M3.5x11	80-T15
S16P SD-CR/L 11	●	●	16	14.8	170	14	≥22					
S20R SD-CR/L 11	●	●	20	18.3	200	15	≥25					
S25S SD-CR/L 11	●	●	25	23	250	18	≥32					
S32T SD-CR/L 11	●	●	32	30	300	22	≥40					
S40U SD-CR/L 11	●	●	40	37.5	350	27	≥50					

R: Sağ / Right / Rechts L: Sol / Left / Links
● Stokta / In Stock / Auf Lager ○ Stokta Yok / Non Stock Item / Kein Lagerartikel, Lieferzeit auf Anfrage

Sipariş Örneği/Ordering Example/Bestellbeispiel
1 ad./pcs./stück S08H SCFCR 06

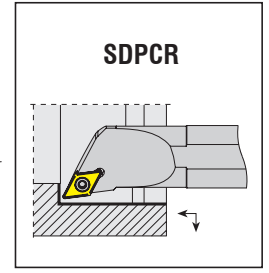
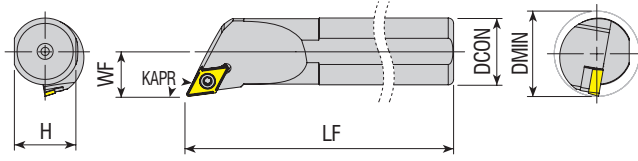

Takım Kodu Ordering Code Bestell-Bezeichnung	Stok Stock Lager		Takım Ölçüleri (mm) Dimension (mm) Abmessung (mm)				Kesici Uç Insert Wendeschneidplatte	Yedek Parçaları / Spare Parts / Ersatzteile				
	R	L	DCON	H	LF	WF		DMIN	Sıkma Vidası Screw Klemmschraube	Altlık Shim Unterlage	Altlık Vidası Shim Screw Schraube für Unterlage	Tork Anahtar Torx Key Torx Innensechskantschlüssel
S10K SDPCR/L 07	●	●	10	09	125	07	≥13	DC.. 0702..	4008-M2.5x6	-	-	82-T08
S12K SDPCR/L 07	●	●	12	11	125	09	≥16					
S16P SDPCR/L 11	●	●	16	14.8	170	11	≥20	DC.. 11T3..	4015-M3.5x9	-	-	80-T15
S20R SDPCR/L 11	●	●	20	18.3	200	13	≥25		4015-M3.5x9	-	-	
S25S SDPCR/L 11	●	●	25	23	250	17	≥32		4015-M3.5x12	AADN-2-0001	AAV-08-M3.5x8	

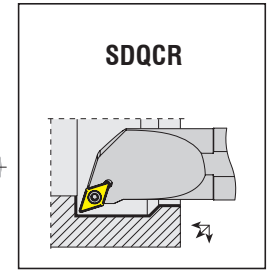
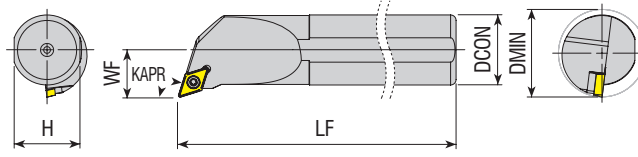

Takım Kodu Ordering Code Bestell-Bezeichnung	Stok Stock Lager		Takım Ölçüleri (mm) Dimension (mm) Abmessung (mm)				Kesici Uç Insert Wendeschneidplatte	Yedek Parçaları / Spare Parts / Ersatzteile				
	R	L	DCON	H	LF	WF		DMIN	Sıkma Vidası Screw Klemmschraube	Altlık Shim Unterlage	Altlık Vidası Shim Screw Schraube für Unterlage	Tork Anahtar Torx Key Torx Innensechskantschlüssel
S10K SDQCR/L 07	●	●	10	09	125	07	≥13	DC.. 0702..	4008-M2.5x6	-	-	82-T08
S12K SDQCR/L 07	●	●	12	11	125	09	≥16					
S16P SDQCR/L 07	●	●	16	14.8	170	11	≥20	DC.. 11T3..	4015-M3.5x9	-	-	80-T15
S20R SDQCR/L 07	●	●	20	18.3	200	13	≥25		4015-M3.5x11	-	-	
S16P SDQCR/L 11	●	●	16	14.8	170	11	≥20		4015-M3.5x12	AADN-2-0001	AAV-08-M3.5x8	
S20R SDQCR/L 11	●	●	20	18.3	200	13	≥25	4015-M3.5x14	AADN-2-0001	AAV-06-M3.5x11		
S25S SDQCR/L 11	●	●	25	23	250	17	≥32	DC.. 11T3..	4015-M3.5x9	-	-	80-T15
S32T SDQCR/L 11	●	●	32	30	300	22	≥40		4015-M3.5x11	-	-	
S40U SDQCR/L 11	●	●	40	37.5	350	27	≥50	4015-M3.5x12	AADN-2-0001	AAV-08-M3.5x8		
A10H SDQCR/L 07	●	●	10	09	100	07	≥13	DC.. 0702..	4008-M2.5x6	-	-	82-T08
A12H SDQCR/L 07	●	●	12	11	100	09	≥16					
A16M SDQCR/L 07	●	●	16	14.8	150	11	≥20	DC.. 11T3..	4015-M3.5x9	-	-	80-T15
A20P SDQCR/L 07	●	●	20	18.3	170	13	≥25		4015-M3.5x11	-	-	
A16M SDQCR/L 11	●	●	16	14.8	150	11	≥20		4015-M3.5x12	AADN-2-0001	AAV-08-M3.5x8	
A20P SDQCR/L 11	●	●	20	18.3	170	13	≥25	4015-M3.5x14	AADN-2-0001	AAV-06-M3.5x11		
A25R SDQCR/L 11	●	●	25	23	200	17	≥32	DC.. 11T3..	4015-M3.5x9	-	-	80-T15
A32S SDQCR/L 11	●	●	32	30	250	22	≥40		4015-M3.5x11	-	-	



KAPR=93°

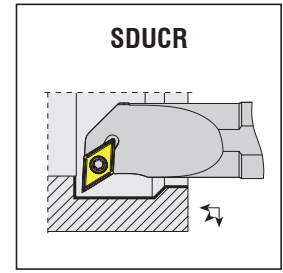
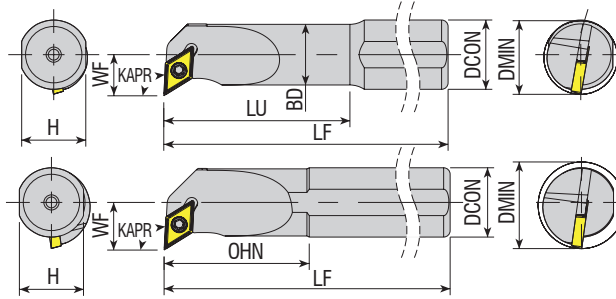

Takım Kodu
Ordering Code
Bestell-Bezeichnung

Stok Stock Lager	Takım Ölçüleri (mm) Dimension (mm) Abmessung (mm)									Kesici Uç Insert Wendeschneidplatte	Yedek Parçaları / Spare Parts / Ersatzteile				
	R	L	DCON	BD	H	LU=OHN	LF	WF	DMIN		Sıkma Vidası Screw Klemmschraube	Altılık Shim Unterlage	Altılık Vidası Shim Screw Schraube für Unterlage	Tork Anahtar Torx Key Torx Innenschlüssel	
	●	●	10	8	09	30	125	08	≥13	DC.. 0702..	4008-M2.5x6	-	-	82-T08	
new	●	●	10	9.5	9	30	150	8	≥13						
	●	●	10	10	09	25	125	08	≥13						
	●	●	12	12	11	25	125	09	≥16						
	●	●	16	11.5	14.8	37	170	09	≥16						
	●	●	16	14	14.8	45	170	9.5	≥17						
	●	●	16	16	14.8	35	170	11	≥20						
	●	●	20	20	18.3	40	200	13	≥25						
	●	●	16	14	14.8	45	170	11	≥18	DC.. 11T3..	4015-M3.5x9	-	-	80-T15	
	●	●	16	16	14.8	35	170	11	≥20						
	●	●	20	16	18.3	50	200	11	≥20						
	●	●	20	20	18.3	40	200	13	≥25						
	●	●	25	25	23	50	250	17	≥32						
	●	●	25	25	23	50	300	17	≥32						
	●	●	32	32	30	60	300	22	≥40						
	●	●	40	40	37.5	70	350	27	≥50						
	●	●	50	50	47	80	400	35	≥63						
	●	●	10	8	09	30	100	08	≥13	DC.. 0702..	4008-M2.5x6	-	-	82-T08	
	●	●	10	10	09	25	100	08	≥13						
	●	●	12	12	11	25	100	09	≥16						
	●	●	16	16	14.8	35	150	11	≥20						
	●	●	20	20	18.3	40	170	13	≥25						
	●	●	16	16	14.8	35	150	11	≥20						
	●	●	20	20	18.3	40	170	13	≥25						
	●	●	25	25	23	50	200	17	≥32	DC.. 11T3..	4015-M3.5x9	-	AAV-08-M3.5x8	80-T15	
	●	●	20	20	18.3	40	170	13	≥25						
	●	●	25	25	23	50	200	17	≥32						
	●	○	25	25	23	50	300	17	≥32						
	●	●	32	32	30	60	250	22	≥40						
	●	○	50	50	47	80	350	35	≥63						
	●	○	50	50	47	80	350	35	≥63						

R: Sağ / Right / Rechts L: Sol / Left / Links

● Stokta / In Stock / Auf Lager ○ Stokta Yok / Non Stock Item / Kein Lagerartikel, Lieferzeit auf Anfrage

Sipariş Örneği/Ordering Example/Bestellbeispiel

1 ad./pcs./stück S0810K SDUCR 07

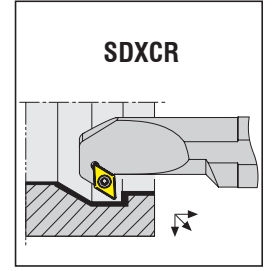
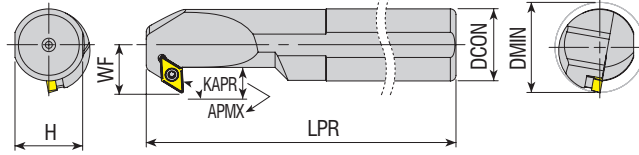

Takım Kodu Ordering Code Bestell-Bezeichnung	Stok Stock Lager		Takım Ölçüleri (mm) Dimension (mm) Abmessung (mm)					Kesici Uç Insert Wendeschneidplatte	Yedek Parçaları / Spare Parts / Ersatzteile				
	R	L	DCON	H	LPR	WF	APMX		DMIN	Sıkma Vidası Screw Klemmschraube	Altlık Shim Unterlage	Altlık Vidası Shim Screw Schraube für Unterlage	Tork Anahtar Torx Key Torx Innensechskantschlüssel
S12K SDXCR/L 07	●	●	12	11	125	09	4.5	≥16	DC.. 0702..	4008-M2.5x6	-	-	82-T08
S16P SDXCR/L 07	●	●	16	14.8	170	11	6.5	≥20		4015-M3.5x9	-	-	
S20R SDXCR/L 07	●	●	20	18.3	200	13	6.5	≥25		-	-	-	
S16P SDXCR/L 11	●	●	16	14.8	170	11	6.5	≥20	DC.. 11T3..	4015-M3.5x14	AADN-2-0001	AAV-08-M3.5x8	80-T15
S20R SDXCR/L 11	●	●	20	18.3	200	14	7.5	≥25		-	-	AAV-06-M3.5x11	
S25S SDXCR/L 11	●	●	25	23	250	17	9	≥32		-	-	-	
S32T SDXCR/L 11	●	●	32	30	300	22	12.5	≥40		-	-	-	
S40U SDXCR/L 11	●	●	40	37.5	350	27	14.5	≥50	-	-	-	-	
A12H SDXCR/L 07	●	●	12	11	100	09	4.5	≥16	DC.. 0702..	4008-M2.5x6	-	-	82-T08
A16M SDXCR/L 07	●	●	16	14.8	150	11	6.5	≥20		4015-M3.5x11	-	-	
A20P SDXCR/L 07	●	●	20	18.3	170	13	6.5	≥25		-	-	-	
A16M SDXCR/L 11	●	●	16	14.8	150	11	7.5	≥20	DC.. 11T3..	4015-M3.5x14	AADN-2-0001	AAV-08-M3.5x8	80-T15
A20P SDXCR/L 11	●	●	20	18.3	170	14	7.5	≥25		-	-	AAV-06-M3.5x11	
A25R SDXCR/L 11	●	●	25	23	200	17	9	≥32		-	-	-	
A32S SDXCR/L 11	●	●	32	30	250	22	12.5	≥40	-	-	-	-	

R: Sağ / Right / Rechts L: Sol / Left / Links
● Stokta / In Stock / Auf Lager ○ Stokta Yok / Non Stock Item / Kein Lagerartikel, Lieferzeit auf Anfrage
Not: "APMX" ölçüleri R0.4'e göre verilmiştir.
Note: Dimensions of "APMX" are given according to R.0,4
Hinweis: Das Maß "APMX" bezieht sich auf R 0,4

Sipariş Örneği/Ordering Example/Bestellbeispiel
1 ad./pcs./stück S12K SDXCR 07

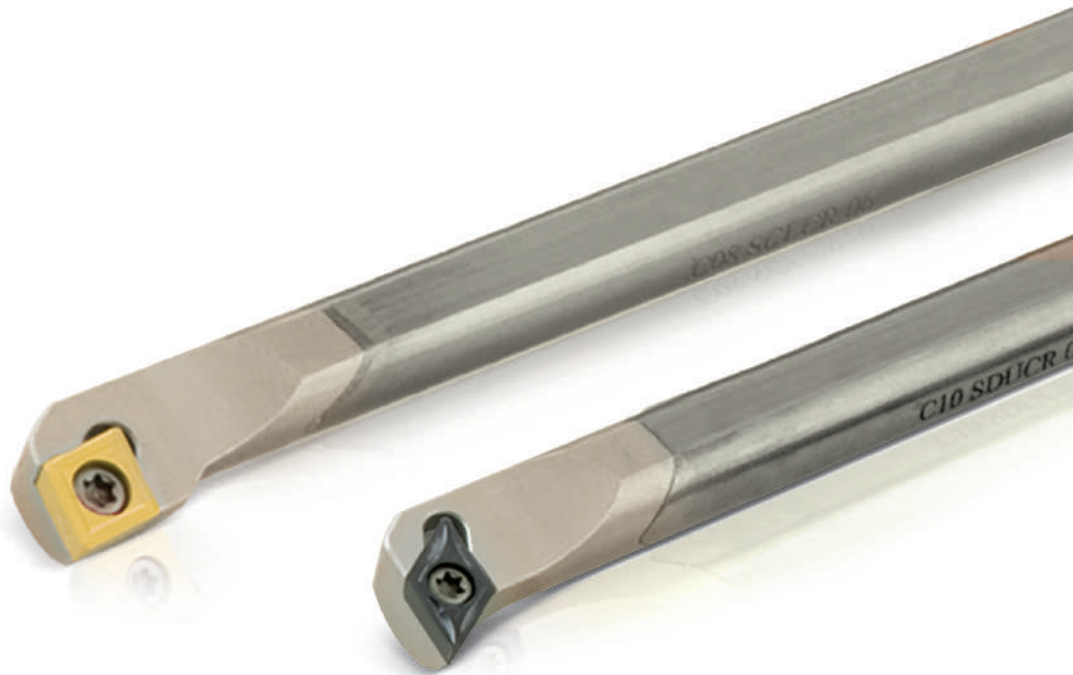

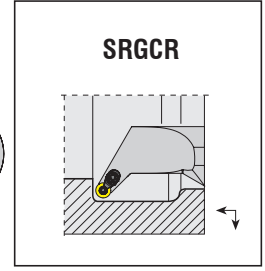
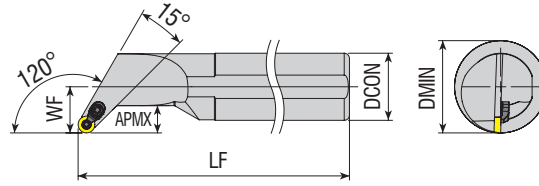
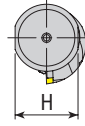

Takım Kodu
Ordering Code
Bestell-Bezeichnung

Stok Stock Lager	Takım Ölçüleri (mm) Dimension (mm) Abmessung (mm)							Kesici Uç Insert Wendeschneidplatte	Sıkma Vidası Screw Klemmschraube	Yedek Parçaları / Spare Parts / Ersatzteile						
	R	L	DCON	H	LF	WF	APMX			DMIN	Altlık Shim Unterlage	Altlık Vidası Shim Screw Schraube für Unterlage	Baskı Pabucu Shim Screw Spann Patze	Pabuç Vidası Shim Screw Klemmschraube	Anahtar Allen Key Innensechskantschlüssel	
	●	○	16	14.8	170	11	7	≥22	RC.. 0803..	3008-M3x8	-	-	-	-	-	
S16P SRGCR/L 08	●	○	16	14.8	170	11	7	≥22			-	-	-	-	-	-
S20R SRGCR/L 08	●	○	20	18.3	200	13	7	≥26			-	-	-	-	-	-
S25S SRGCR/L 08C	●	○	25	23	250	17	9.5	≥34			-	-	-	-	-	-
S32T SRGCR/L 08C	●	○	32	30	300	22	13	≥44			-	-	ACK-15	4015-M3.5x11	-	-
S40U SRGCR/L 08C	●	○	40	37.5	350	27	15	≥54			-	-	-	-	-	-
A16M SRGCR/L 08	●	○	16	14.8	150	11	7	≥22			-	-	-	-	-	-
A20P SRGCR/L 08	●	○	20	18.3	170	13	7	≥26			-	-	-	-	-	-
A25R SRGCR/L 08C	●	○	25	23	200	17	9.5	≥34			-	-	-	-	-	-
A32S SRGCR/L 08C	●	○	32	30	250	22	13	≥44			-	-	ACK-15	4015-M3.5x11	-	-
A40T SRGCR/L 08C	●	○	40	37.5	300	27	15	≥54	-	-	-	-	-	-		



KAPR=45°

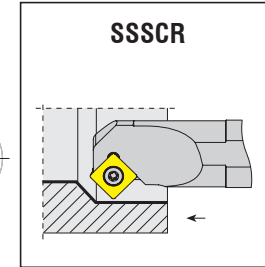
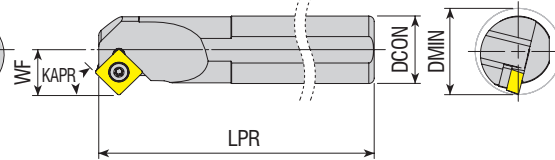
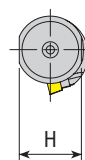

Takım Kodu
Ordering Code
Bestell-Bezeichnung

Stok Stock Lager	Takım Ölçüleri (mm) Dimension (mm) Abmessung (mm)							Kesici Uç Insert Wendeschneidplatte	Sıkma Vidası Screw Klemmschraube	Yedek Parçaları / Spare Parts / Ersatzteile			Tork Anahtar Torx Key Innensechskantschlüssel		
	R	L	DCON	H	LPR	WF	DMIN			Altlık Shim Unterlage	Altlık Vidası Shim Screw Schraube für Unterlage	Tork Anahtar Torx Key Innensechskantschlüssel			
	●	○	16	14.8	170	11	≥20	SC.. 09T3..	4015-M3.5x9	-	-	-	-		
S16P SSSCR/L 09	●	○	16	14.8	170	11	≥20			-	-	-	-	-	
S20R SSSCR/L 09	●	○	20	18.3	200	13	≥25			-	-	-	-	-	
S25S SSSCR/L 09	●	○	25	23	250	17	≥32	SC.. 1204..	4015-M3.5x12 4020-M4.5x12 1020-M4.5x16	AASN-2-0001	AAV-08-M3.5x8	-	-		
S25S SSSCR/L 12	●	○	25	23	250	17	≥32			-	-	-	-	-	
S32T SSSCR/L 12	●	○	32	30	300	22	≥40			-	-	AASN-2-0004	AAV-10-M4.5x8	-	-
S40U SSSCR/L 12	●	○	40	37.5	350	27	≥50			-	-	-	AAV-07-M4.5x8	-	-

R: Sağ / Right / Rechts L: Sol / Left / Links
● Stokta / In Stock / Auf Lager ○ Stokta Yok / Non Stock Item / Kein Lagerartikel, Lieferzeit auf Anfrage

Sipariş Örneği/Ordering Example/Bestellbeispiel
1 ad./pcs./stück S16P SRGCR 08

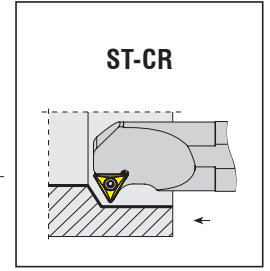
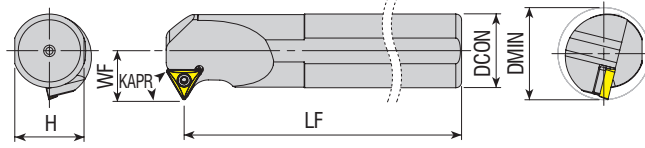

Takım Kodu Ordering Code Bestell-Bezeichnung	Stok Stock Lager		Takım Ölçüleri (mm) Dimension (mm) Abmessung (mm)					Kesici Uç Insert Wendeschneidplatte	Yedek Parçaları / Spare Parts / Ersatzteile			
	R	L	DCON	H	LF	WF	DMIN		Sıkma Vidası Screw Klemmschraube	Altılık Shim Unterlage	Altılık Vidası Shim Screw Schraube für Unterlage	Tork Anahtar Torx Key Torx Innensechskantschlüssel
	●	○										
S12K ST-CR/L 11	●	●	12	11	125	09	≥17	TC.. 1102..	4008-M2.5x6	-	-	82-T08
S16P ST-CR/L 11	●	○	16	14.8	170	11	≥20					
S20R ST-CR/L 11	●	○	20	18.3	200	13	≥25					
S16P ST-CR/L 16	●	●	16	14.8	170	11	≥20	TC.. 16T3..	4015-M3.5x9	-	-	80-T15
S20R ST-CR/L 16	●	●	20	18.3	200	13	≥25		4015-M3.5x11			
S25S ST-CR/L 16	●	●	25	23	250	17	≥32		4015-M3.5x14			
S32T ST-CR/L 16	●	●	32	30	300	22	≥40	AAV-06-M3.5x11				
S40U ST-CR/L 16	●	●	40	37.5	350	27	≥50					

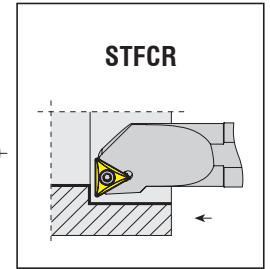
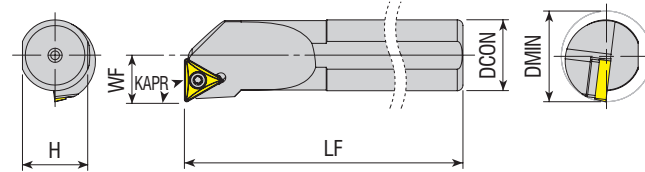

Takım Kodu Ordering Code Bestell-Bezeichnung	Stok Stock Lager		Takım Ölçüleri (mm) Dimension (mm) Abmessung (mm)					Kesici Uç Insert Wendeschneidplatte	Yedek Parçaları / Spare Parts / Ersatzteile			
	R	L	DCON	H	LF	WF	DMIN		Sıkma Vidası Screw Klemmschraube	Altılık Shim Unterlage	Altılık Vidası Shim Screw Schraube für Unterlage	Tork Anahtar Torx Key Torx Innensechskantschlüssel
	●	○										
S0610F STF-CR/L 06	●	●	10	09	80	4.5	≥08	TC.. 06T1..	3006-M2x4	-	-	82-T06
S08H STF-CR/L 06	●	●	08	7.3	100	06	≥11					
S10K STF-CR/L 09	●	●	10	09	125	07	≥13	TC.. 0902..	3007-M2.2x4.6	-	-	82-T07
S12K STF-CR/L 09	●	●	12	11	125	09	≥17					
S12K STF-CR/L 11	●	●	12	11	125	09	≥17	TC.. 1102..	4008-M2.5x6	-	-	82-T08
S16P STF-CR/L 11	●	●	16	14.8	170	11	≥20					
S20R STF-CR/L 11	●	●	20	18.3	200	13	≥25					
S16P STF-CR/L 16	●	●	16	14.8	170	11	≥20	TC.. 16T3..	4015-M3.5x9	-	-	80-T15
S20R STF-CR/L 16	●	●	20	18.3	200	13	≥25		4015-M3.5x11			
S25S STF-CR/L 16	●	●	25	23	250	17	≥32		4015-M3.5x14			
S32T STF-CR/L 16	●	●	32	30	300	22	≥40	AAV-06-M3.5x11				
S40U STF-CR/L 16	●	○	40	37.5	350	27	≥50					
A10H STF-CR/L 11	●	●	10	09	100	07	≥13	TC.. 1102..	4008-M2.5x6	-	-	82-T08
A12H STF-CR/L 11	●	●	12	11	100	09	≥17					
A16M STF-CR/L 11	●	●	16	14.8	150	11	≥20					
A20R STF-CR/L 16	●	○	20	18.3	200	13	≥25	TC.. 16T3..	4015-M3.5x11			80-T15

R: Sağ / Right / Rechts L: Sol / Left / Links

● Stokta / In Stock / Auf Lager ○ Stokta Yok / Non Stock Item / Kein Lagerartikel, Lieferzeit auf Anfrage

Sipariş Örneği/Ordering Example/Bestellbeispiel

1 ad./pcs./stück S12K ST-CR 11

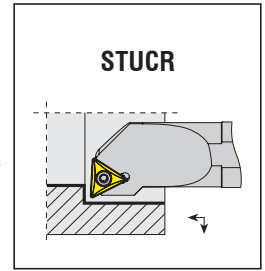
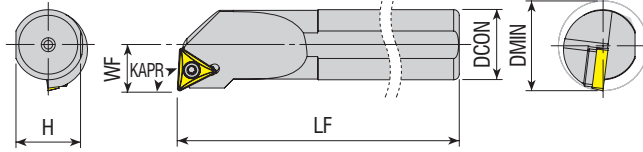

Takım Kodu
Ordering Code
Bestell-Bezeichnung

Stok
Stock
Lager

Takım Ölçüleri (mm)
Dimension (mm)
Abmessung (mm)

Kesici Uç
Insert
Wendeschneidplatte

Sıkma Vidası
Screw
Klemmschraube

Yedek Parçaları / Spare Parts / Ersatzteile

Aitlik
Shim
Unterlage

Aitlik Vidası
Shim Screw
Schraube für Unterlage

Tork Anahtar
Torx Key
Torx Innensechskantschlüssel

R L DCON H LF WF DMIN



S10K STUCR/L 09	●●	10	09	125	07	≥13	TC.. 0902..	3007-M2.2x4.6			82-T07
S12K STUCR/L 09	●●	12	11	125	09	≥16					
S12K STUCR/L 11	●●	12	11	125	09	≥17	TC.. 1102..	4008-M2.5x6	-	-	82-T08
S16P STUCR/L 11	●●	16	14.8	170	11	≥20					
S20R STUCR/L 11	●●	20	18.3	200	13	≥25	TC.. 16T3..	4015-M3.5x9 4015-M3.5x11	-	-	80-T15
S16P STUCR/L 16	●●	16	14.8	170	11	≥20					
S20R STUCR/L 16	●●	20	18.3	200	13	≥25	TC.. 16T3..	4015-M3.5x14	AATN-2-0001	AAV-08-M3.5x8 AAV-06-M3.5x11	80-T15
S25S STUCR/L 16	●●	25	23	250	17	≥32					
S32T STUCR/L 16	●●	32	30	300	22	≥40	TC.. 0902..	3007-M2.2x4.6			82-T07
S40U STUCR/L 16	●●	40	37.5	350	27	≥50					
A10H STUCR/L 09	●●	10	09	100	07	≥13	TC.. 1102..	4008-M2.5x6	-	-	82-T08
A12H STUCR/L 09	●●	12	11	100	09	≥16					
A12H STUCR/L 11	●●	12	11	100	09	≥16	TC.. 16T3..	4015-M3.5x9 4015-M3.5x11	-	-	80-T15
A16M STUCR/L 11	●●	16	14.8	150	11	≥20					
A20P STUCR/L 11	●●	20	18.3	170	13	≥25	TC.. 16T3..	4015-M3.5x12 4015-M3.5x14	AATN-2-0001	AAV-08-M3.5x8 AAV-06-M3.5x11	80-T15
A16M STUCR/L 16	●●	16	14.8	150	11	≥20					
A20P STUCR/L 16	●●	20	18.3	170	13	≥25					
A25R STUCR/L 16	●●	25	23	200	17	≥32					
A32S STUCR/L 16	●●	32	30	250	22	≥40					

R: Sağ / Right / Rechts L: Sol / Left / Links

● Stokta / In Stock / Auf Lager ○ Stokta Yok / Non Stock Item / Kein Lagerartikel, Lieferzeit auf Anfrage

Sipariş Örneği/Ordering Example/Bestellbeispiel

1 ad./pcs./stück S10K STUCR 09



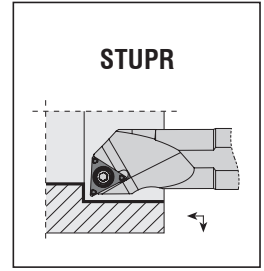
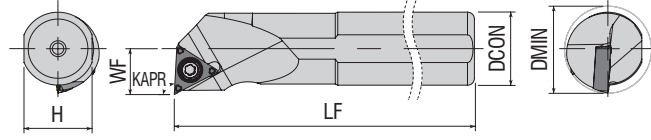

Takım Kodu Ordering Code Bestell-Bezeichnung	Stok Stock Lager	Takım Ölçüleri (mm) Dimension (mm) Abmessung (mm)						Kesici Uç Insert Wendeschneidplatte	Yedek Parçaları / Spare Parts / Ersatzteile				
		R	L	DCON	H	LF	WF		DMIN	Sıkma Vidası Screw Klemmschraube	Altlık Shim Unterlage	Altlık Vidası Shim Screw Schraube für Unterlage	Tork Anahtar Torx Key Torx Innensechskantschlüssel
S08H STUPR/L 0802	● ○	08	7.3	100	05	≥10	TP. 0802..	3006-M2x4				82-T06	
S10K STUPR/L 1103	● ○	10	09	125	06	≥12							
S12K STUPR/L 1103	● ●	12	11	125	09	≥16	TP. 1103..	4010-M3x6	-	-	82-T10		
S12M STUPR/L 1103	● ●	12	11	150	09	≥16							
S16P STUPR/L 1103	● ●	16	14.8	170	10	≥20							
S16R STUPR/L 1103	● ●	16	14.8	200	10	≥20							
A20R STUPR/L 1103	● ○	20	18.3	200	13	≥25							

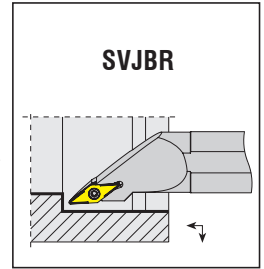
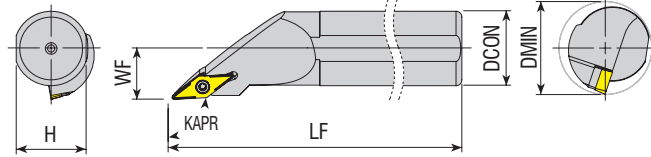

Takım Kodu Ordering Code Bestell-Bezeichnung	Stok Stock Lager	Takım Ölçüleri (mm) Dimension (mm) Abmessung (mm)						Kesici Uç Insert Wendeschneidplatte	Yedek Parçaları / Spare Parts / Ersatzteile				
		R	L	DCON	H	LF	WF		DMIN	Sıkma Vidası Screw Klemmschraube	Altlık Shim Unterlage	Altlık Vidası Shim Screw Schraube für Unterlage	Tork Anahtar Torx Key Torx Innensechskantschlüssel
S25S SVJBR/L 16	● ●	25	23	250	17	≥32	VB.. 1604..	4015-M3.5x12	AAVN-2-0002	AAV-08-M3.5x8	80-T15		
S32T SVJBR/L 16	● ●	32	30	300	22	≥40							
S40U SVJBR/L 16	● ●	40	37.5	350	27	≥50						4015-M3.5x14	AAV-06-M3.5x11

R: Sağ / Right / Rechts L: Sol / Left / Links
● Stokta / In Stock / Auf Lager ○ Stokta Yok / Non Stock Item / Kein Lagerartikel, Lieferzeit auf Anfrage

Sipariş Örneği/Ordering Example/Bestellbeispiel
1 ad./pcs./stück S08H STUPR 0802

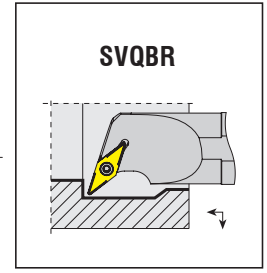
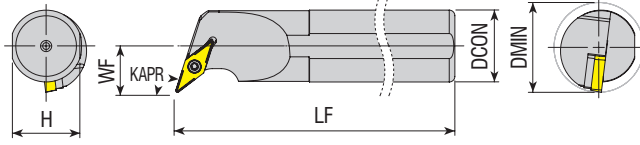

Takım Kodu Ordering Code Bestell-Bezeichnung	Stok Stock Lager		Takım Ölçüleri (mm) Dimension (mm) Abmessung (mm)				Kesici Uç Insert Wendeschneidplatte	Sıkma Vidası Screw Klemmschraube	Altlık Shim Unterlage	Altlık Vidası Shim Screw Schraube für Unterlage	Tork Anahtar Torx Key Torx Innensechskantschlüssel	
	R	L	DCON	H	LF	WF						DMIN
S16P SVQBR/L 11	●	●	16	14.8	170	11	≥20	VB.. 1103..	4008-M2.5x6	-	-	82-T08
S20R SVQBR/L 11	●	●	20	18.3	200	13	≥25					
S25S SVQBR/L 16	●	●	25	23	250	17	≥32	VB.. 1604..	4015-M3.5x14	AAVN-2-0002	AAV-08-M3.5x8	80-T15
S32T SVQBR/L 16	●	●	32	30	300	22	≥40				AAV-06-M3.5x11	
S40U SVQBR/L 16	●	●	40	37.5	350	27	≥50	VB.. 1103..	4008-M2.5x6	-	-	82-T08
A20Q SVQBR/L 11	●	●	20	18.3	180	13	≥25					
A20Q SVQBR/L 16	●	●	20	18.5	180	20	≥30	VB.. 1604..	4015-M3.5x11	-	-	80-T15
A25S SVQBR/L 16	●	●	25	23	250	17	≥32					
A32S SVQBR/L 16	●	●	32	30	250	22	≥40	4015-M3.5x14	AAVN-2-0002	AAV-08-M3.5x8		

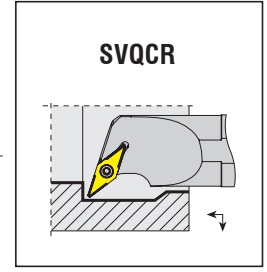
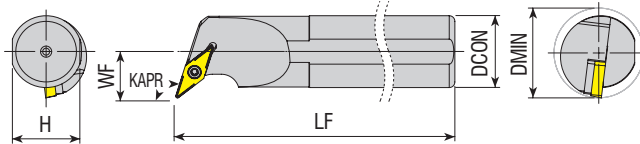

Takım Kodu Ordering Code Bestell-Bezeichnung	Stok Stock Lager		Takım Ölçüleri (mm) Dimension (mm) Abmessung (mm)				Kesici Uç Insert Wendeschneidplatte	Sıkma Vidası Screw Klemmschraube	Altlık Shim Unterlage	Altlık Vidası Shim Screw Schraube für Unterlage	Tork Anahtar Torx Key Torx Innensechskantschlüssel	
	R	L	DCON	H	LF	WF						DMIN
S16P SVQCR/L 11	●	●	16	14.8	170	11	≥20	VC.. 1103..	4008-M2.5x6	-	-	82-T08
S20R SVQCR/L 11	●	●	20	18.3	200	13	≥25					
S25S SVQCR/L 16	●	●	25	23	250	17	≥32	VC.. 1604..	4015-M3.5x14	AAVN-2-0002	AAV-08-M3.5x8	80-T15
S32T SVQCR/L 16	●	●	32	30	300	22	≥40				AAV-06-M3.5x11	
S40U SVQCR/L 16	●	●	40	37.5	350	27	≥50	VC.. 1103..	4008-M2.5x6	-	-	82-T08
A16M SVQCR/L 11	●	●	16	14.8	150	11	≥20					
A20P SVQCR/L 11	●	●	20	18.3	170	13	≥25	VC.. 1604..	4015-M3.5x14	AAVN-2-0002	AAV-08-M3.5x8	80-T15
A25R SVQCR/L 16	●	●	25	23	200	17	≥32				AAV-06-M3.5x11	
A32S SVQCR/L 16	●	●	32	30	250	22	≥40					
A40T SVQCR/L 16	●	●	40	37.5	300	27	≥50					

R: Sağ / Right / Rechts L: Sol / Left / Links
● Stokta / In Stock / Auf Lager ○ Stokta Yok / Non Stock Item / Kein Lagerartikel, Lieferzeit auf Anfrage

Sipariş Örneği/Ordering Example/Bestellbeispiel
1 ad./pcs./stück S16P SVQBR 11

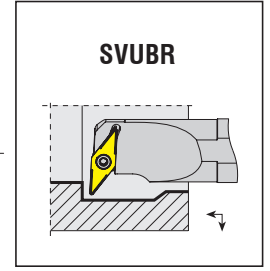
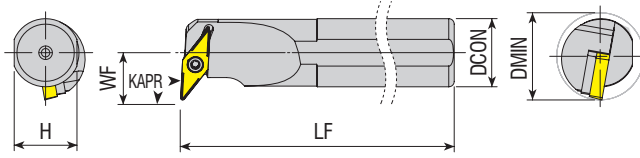

Takım Kodu Ordering Code Bestell-Bezeichnung	Stok Stock Lager		Takım Ölçüleri (mm) Dimension (mm) Abmessung (mm)				Kesici Uç Insert Wendeschneidplatte	Yedek Parçaları / Spare Parts / Ersatzteile				
	R	L	DCON	H	LF	WF		DMIN	Sıkma Vidası Screw Klemmschraube	Altık Shim Unterlage	Altık Vidası Shim Screw Schraube für Unterlage	Tork Anahtar Torx Key Torx Innensechskantschlüssel
S16P SVUBR/L 11	●	●	16	14.8	170	12.5	≥20	VB.. 1103..	4008-M2.5x6	-	-	82-T08
S20R SVUBR/L 11	●	●	20	18.3	200	13	≥25					
S25S SVUBR/L 16	●	●	25	23	250	19	≥32	VB.. 1604..	4015-M3.5x14	AAVN-2-0002	AAV-06-M3.5x11	80-T15
S32T SVUBR/L 16	●	●	32	30	300	22	≥40					
S40U SVUBR/L 16	●	●	40	37.5	350	27	≥50					
A20Q SVUBR/L 16	●	○	20	18.3	180	20	≥30					
A32S SVUBR/L 16	●	●	32	30	250	22	≥40	4015-M3.5x14	AAVN-2-0002	AAV-06-M3.5x11		

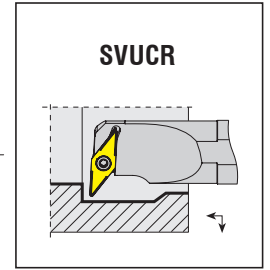
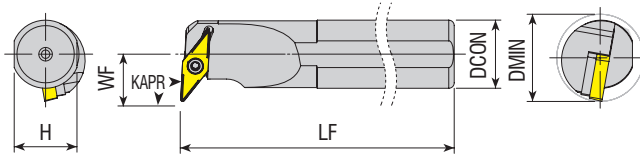

Takım Kodu Ordering Code Bestell-Bezeichnung	Stok Stock Lager		Takım Ölçüleri (mm) Dimension (mm) Abmessung (mm)				Kesici Uç Insert Wendeschneidplatte	Yedek Parçaları / Spare Parts / Ersatzteile				
	R	L	DCON	H	LF	WF		DMIN	Sıkma Vidası Screw Klemmschraube	Altık Shim Unterlage	Altık Vidası Shim Screw Schraube für Unterlage	Tork Anahtar Torx Key Torx Innensechskantschlüssel
S16P SVUCR/L 11	●	●	16	14.8	170	12.5	≥20	VC.. 1103..	4008-M2.5x6	-	-	82-T08
S20R SVUCR/L 11	●	●	20	18.3	200	13	≥25					
S25S SVUCR/L 16	●	●	25	23	250	19	≥32	VC.. 1604..	4015-M3.5x14	AAVN-2-0002	AAV-06-M3.5x11	80-T15
S32T SVUCR/L 16	●	●	32	30	300	22	≥40					
S40U SVUCR/L 16	●	●	40	37.5	350	27	≥50					
A12K SVUCR/L 07	●	●	12	11	125	9	≥16					
A20P SVUCR/L 11	●	○	20	18.3	170	13	≥25	VC.. 1103..	4008-M2.5x6	-	-	82-T08
A20Q SVUCR/L 11	●	●	20	18.3	180	13	≥25	VC.. 1103..	4008-M2.5x6	-	-	82-T08
A25R SVUCR/L 16	●	●	25	23	200	19	≥32	VC.. 1604..	4015-M3.5x14	AAVN-2-0002	AAV-06-M3.5x11	80-T15

R: Sağ / Right / Rechts L: Sol / Left / Links

● Stokta / In Stock / Auf Lager ○ Stokta Yok / Non Stock Item / Kein Lagerartikel, Lieferzeit auf Anfrage

Sipariş Örneği/Ordering Example/Bestellbeispiel

1 ad./pcs./stück S16P SVUBR 11

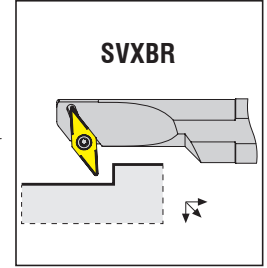
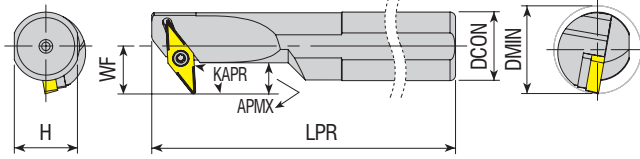

Takım Kodu Ordering Code Bestell-Bezeichnung	Stok Stock Lager		Takım Ölçüleri (mm) Dimension (mm) Abmessung (mm)					Kesici Uç Insert Wendeschneidplatte	Yedek Parçaları / Spare Parts / Ersatzteile				
	R	L	DCON	H	LPR	WF	APMX		DMIN	Sıkma Vidası Screw Klemmschraube	Altlık Shim Unterlage	Altlık Vidası Shim Screw Schraube für Unterlage	Tork Anahtar Torx Key Torx Innensechskantschlüssel
S16P SVXBR/L 1102	●	○	16	14.8	170	12.5	7.2	≥20	VB.. 1102..	4008-M2.5x6	-	-	82-T08
S20R SVXBR/L 1102	●	●	20	18.3	200	13	5.7	≥25					
S16P SVXBR/L 11	●	●	16	14.8	170	12.5	7.2	≥21	VB.. 1103..				
S20R SVXBR/L 11	●	●	20	18.3	200	13	5.7	≥25					
S25S SVXBR/L 16	●	●	25	23	250	19	10.2	≥32	VB.. 1604..	4015-M3.5x14	AAVN-2-0002	AAV-06-M3.5x11	80-T15
S32T SVXBR/L 16	●	●	32	30	300	22	11.7	≥40					
S40U SVXBR/L 16	●	●	40	37.5	350	27	14.3	≥50					

Not: "APMX" ölçüleri R0.4'e göre verilmiştir.
Note: Dimensions of "APMX" are given according to R0,4
Hinweis: Das Maß "APMX" bezieht sich auf R 0,4

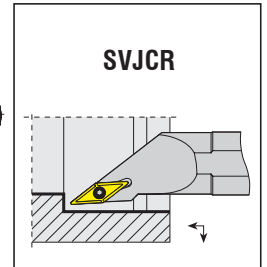
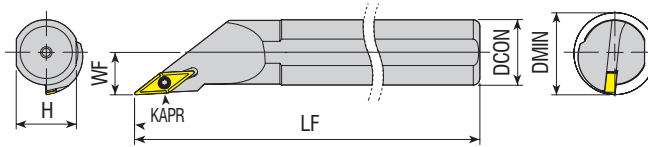

Takım Kodu Ordering Code Bestell-Bezeichnung	Stok Stock Lager		Takım Ölçüleri (mm) Dimension (mm) Abmessung (mm)					Kesici Uç Insert Wendeschneidplatte	Yedek Parçaları / Spare Parts / Ersatzteile			
	R	L	DCON	H	LF	WF	DMIN		Sıkma Vidası Screw Klemmschraube	Altlık Shim Unterlage	Altlık Vidası Shim Screw Schraube für Unterlage	Tork Anahtar Torx Key Torx Innensechskantschlüssel
S12K SVJCR/L 11	●	●	12	11	125	7	≥13	VC.. 1103..	4008-M2.5x6	-	-	82-T08
S16P SVJCR/L 11	●	●	16	14.8	170	11	≥20					
S20R SVJCR/L 11	●	●	20	18.3	200	13	≥25					
A12H SVJCR/L 11	●	●	12	11	100	07	≥13					
A16M SVJCR/L 11	●	●	16	14.8	150	11	≥20					
A20P SVJCR/L 11	●	●	20	18.3	170	13	≥25					

R: Sağ / Right / Rechts L: Sol / Left / Links
● Stokta / In Stock / Auf Lager ○ Stokta Yok / Non Stock Item / Kein Lagerartikel, Lieferzeit auf Anfrage

Sipariş Örneği/Ordering Example/Bestellbeispiel
1 ad./pcs./stück S16P SVXBR 1102

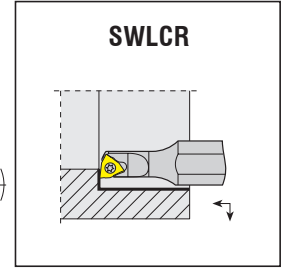
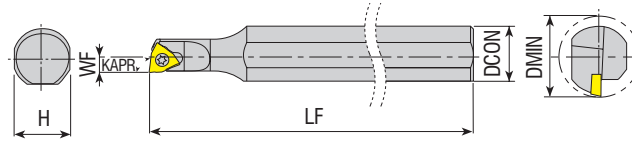

Takım Kodu Ordering Code Bestell-Bezeichnung	Stok Stock Lager		Takım Ölçüleri (mm) Dimension (mm) Abmessung (mm)					Kesici Uç Insert Wendeschneidplatte	Yedek Parçaları / Spare Parts / Ersatzteile				
	R	L	DCON	H	LF	WF	DMIN		Sıkma Vidası Screw Klemmschraube	Altık Shim Unterlage	Altık Vidası Shim Screw Schraube für Unterlage	Tork Anahtar Torx Key Torx Innensechskantschlüssel	
	●	○											
S0608H SWLCR/L 03	●	○	08	7.3	100	04	≥08	WC.. 0302..	4008-M2.5x4				82-T08
S0810K SWLCR/L 03	●	○	10	09	125	06	≥10		4008-M2.5x4.5	-	-		

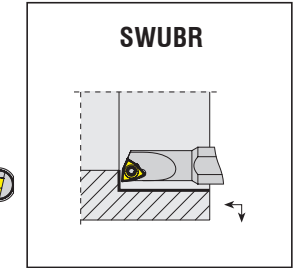
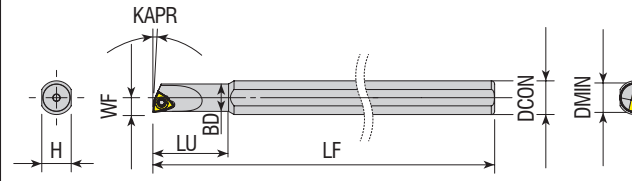

Takım Kodu Ordering Code Bestell-Bezeichnung	Stok Stock Lager		Takım Ölçüleri (mm) Dimension (mm) Abmessung (mm)							Kesici Uç Insert Wendeschneidplatte	Yedek Parçaları / Spare Parts / Ersatzteile			
	R	L	DCON	BD	H	LU	LF	DMIN	WF		Sıkma Vidası Screw Klemmschraube	Altık Shim Unterlage	Altık Vidası Shim Screw Schraube für Unterlage	Tork Anahtar Torx Key Torx Innensechskantschlüssel
	●	○												
S0610H SWUBR/L 06	●	○	10	5	7.3	18	100	≥6	3	WBGT 060102-L	3006-M2x3.3	-	-	82-T06
S08H SWUBR/L 06-5.5	●	●	08	5	7.3	18	100	≥5.7	2.75					
S08H SWUBR/L 06-7	●	○	08	6.5	7.3	18	100	≥7	3.5					

R: Sağ / Right / Rechts L: Sol / Left / Links
● Stokta / In Stock / Auf Lager ○ Stokta Yok / Non Stock Item / Kein Lagerartikel, Lieferzeit auf Anfrage
KYCR-ISCR Ucuna Uygun. / Compatible with KYCR-ISCR Insert. / Kompatibel mit KYCR-ISCR Wendeplatten.

Sipariş Örneği/Ordering Example/Bestellbeispiel
1 ad./pcs./stück S0608H SWLCR 03

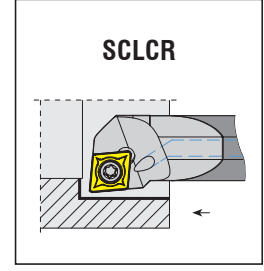
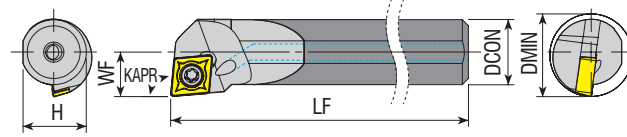

Takım Kodu Ordering Code Bestell-Bezeichnung	Stok Stock Lager		Takım Ölçüleri (mm) Dimension (mm) Abmessung (mm)					Kesici Uç Insert Wendeschneidplatte	Yedek Parçaları / Spare Parts / Ersatzteile				
	R	L	DCON	H	LF	WF	DMIN		Sıkma Vidası Screw Klemmschraube	Altlık Shim Unterlage	Altlık Vidası Shim Screw Schraube für Unterlage	Tork Anahtar Torx Key Torx Innensechskantschlüssel	
C04G SCLCR/L 03	●	○	4	3.7	90	2.5	≥5	CC.. 0301..	4006-M1.6x3.2			82-T06	
C05H SCLCR/L 03	●	○	5	4.7	100	3	≥6						
C06J SCLCR/L 04	●	○	6	5.7	110	3.5	≥7	CC.. 0401..	3006-M2x3.3			82-T08	
C07K SCLCR/L 04	●	○	7	6.7	125	4	≥8						
C06J SCLCR/L 06	●	○	6	5.7	110	4.5	≥8	CC.. 0602..	4008-M2.5x4.5	-	-	82-T08	
E08K SCLCR/L 06	●	●	8	7.5	125	6	≥11						
E10M SCLCR/L 06	●	●	10	9.5	150	7	≥13	CC.. 09T3..	4008-M2.5x6			80-T15	
E12Q SCLCR/L 06	●	●	12	11	180	9	≥16						
E16R SCLCR/L 09	●	●	16	15	200	11	≥20	CC.. 09T3..	4015-M3.5x9			80-T15	
E20S SCLCR/L 09	●	●	20	19	250	13	≥24						

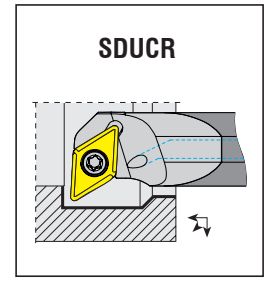
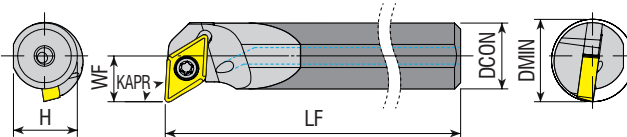



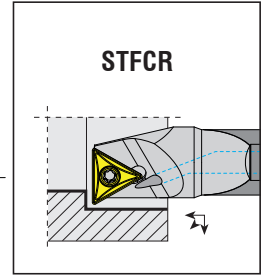
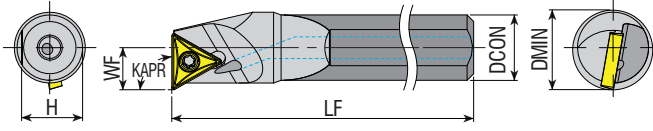

Takım Kodu Ordering Code Bestell-Bezeichnung	Stok Stock Lager		Takım Ölçüleri (mm) Dimension (mm) Abmessung (mm)					Kesici Uç Insert Wendeschneidplatte	Yedek Parçaları / Spare Parts / Ersatzteile				
	R	L	DCON	H	LF	WF	DMIN		Sıkma Vidası Screw Klemmschraube	Altlık Shim Unterlage	Altlık Vidası Shim Screw Schraube für Unterlage	Tork Anahtar Torx Key Torx Innensechskantschlüssel	
E10M SDUCR/L 07	●	●	10	9.5	150	8	≥13	DC.. 0702..	4008-M2.5x6	-	-	82-T08	
E12Q SDUCR/L 07	●	●	12	11	180	9	≥16						
E16R SDUCR/L 11	●	●	16	15	200	11	≥20	DC.. 11T3..	4015-M3.5x9	-	-	80-T15	
E20S SDUCR/L 11	●	●	20	18.3	250	12	≥23						

R: Sağ / Right / Rechts L: Sol / Left / Links
● Stokta / In Stock / Auf Lager ○ Stokta Yok / Non Stock Item / Kein Lagerartikel, Lieferzeit auf Anfrage

Sipariş Örneği/Ordering Example/Bestellbeispiel
1 ad./pcs./stück C04G SCLCR 03





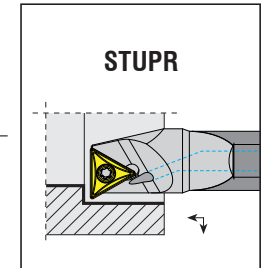
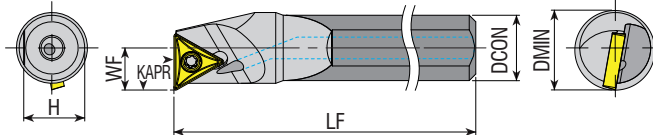

Takım Kodu
Ordering Code
Bestell-Bezeichnung

Takım Kodu Ordering Code Bestell-Bezeichnung	Stok Stock Lager		Takım Ölçüleri (mm) Dimension (mm) Abmessung (mm)				Kesici Uç Insert Wendeschneidplatte	Yedek Parçaları / Spare Parts / Ersatzteile				
	R	L	DCON	H	LF	WF		DMIN	Sıkma Vidası Screw Klemmschraube	Altık Shim Unterlage	Altık Vidası Shim Screw Schraube für Unterlage	Tork Anahtar Torx Key Torx Innensechskantschlüssel
E08K STFCR/L 06	●	○	8	7.5	125	4.5	9.5					
E10M STFCR/L 09	●	●	10	9.5	150	6	12	TC.. 06T1..	3006-M2X4	-	-	82-T06
E12Q STFCR/L 09	●	●	12	11	180	8	15		TC.. 0902..	3007-M2.2x5	-	-
E12Q STFCR/L 11	●	●	12	11	180	8	15	TC.. 1102..	4008-M2.5x6	-	-	82-T08



Takım Kodu
Ordering Code
Bestell-Bezeichnung

Takım Kodu Ordering Code Bestell-Bezeichnung	Stok Stock Lager		Takım Ölçüleri (mm) Dimension (mm) Abmessung (mm)				Kesici Uç Insert Wendeschneidplatte	Yedek Parçaları / Spare Parts / Ersatzteile				
	R	L	DCON	H	LF	WF		DMIN	Sıkma Vidası Screw Klemmschraube	Altık Shim Unterlage	Altık Vidası Shim Screw Schraube für Unterlage	Tork Anahtar Torx Key Torx Innensechskantschlüssel
E12Q STUPR/L 1103	●	○	12	11	180	8	15					
E16R STUPR/L 1103	●	○	16	15	200	11	20					
									4010-M3x8	-	-	

R: Sağ / Right / Rechts L: Sol / Left / Links

● Stokta / In Stock / Auf Lager ○ Stokta Yok / Non Stock Item / Kein Lagerartikel, Lieferzeit auf Anfrage

Sipariş Örneği/Ordering Example/Bestellbeispiel

1 ad./pcs./stückE08K STFCR 06

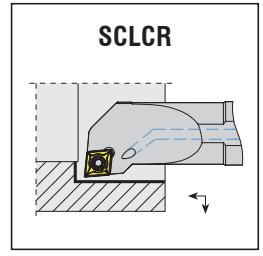
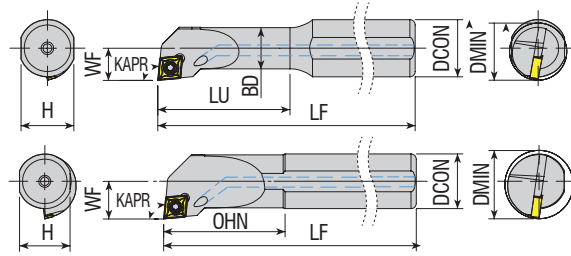

Takım Kodu
Ordering Code
Bestell-Bezeichnung

Stok Stock Lager	Takım Ölçüleri (mm) Dimension (mm) Abmessung (mm)								Kesici Uç Insert Wendeschneidplatte	Yedek Parçaları / Spare Parts / Ersatzteile				
	R	L	DCON	BD	H	LU=OHN	LF	WF		DMIN	Sıkma Vidası Screw Klemmschraube	Altık Shim Unterlage	Altık Vidası Shim Screw Schraube für Unterlage	Tork Anahtar Torx Key Torx Innensechskantschlüssel
A08H SCLCR/L 06	●	●	8	8	7.3	20	100	6	≥11	CC.. 0602..	4008-M2.5x6	-	-	82-T08
A10H SCLCR/L 06	●	●	10	10	9	25	100	7	≥13					
A12H SCLCR/L 06	●	●	12	12	11	25	100	9	≥16					
A16M SCLCR/L 09	●	●	16	16	14.8	35	150	11	≥20					

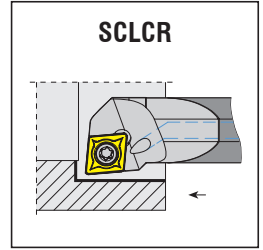
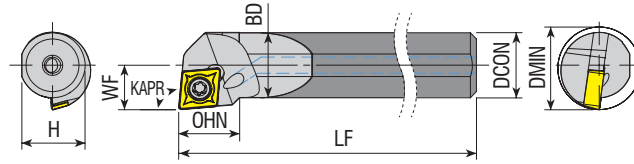

Takım Kodu
Ordering Code
Bestell-Bezeichnung

Stok Stock Lager	Takım Ölçüleri (mm) Dimension (mm) Abmessung (mm)								Kesici Uç Insert Wendeschneidplatte	Yedek Parçaları / Spare Parts / Ersatzteile				
	R	L	DCON	BD	H	OHN	LF	WF		DMIN	Sıkma Vidası Screw Klemmschraube	Altık Shim Unterlage	Altık Vidası Shim Screw Schraube für Unterlage	Tork Anahtar Torx Key Torx Innensechskantschlüssel
E08K SCLCR/L 06	●	●	8	8	7.5	10	125	6	≥11	CC.. 0602..	4008-M2.5x6	-	-	82-T08
E10M SCLCR/L 06	●	●	10	10	9.5	10	150	7	≥13					
E12Q SCLCR/L 06	●	●	12	12	11	12	180	9	≥16					
E16R SCLCR/L 09	●	●	16	16	15	15	200	11	≥20					

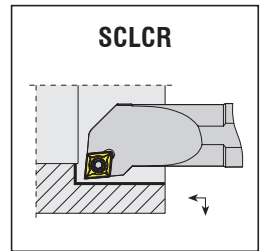
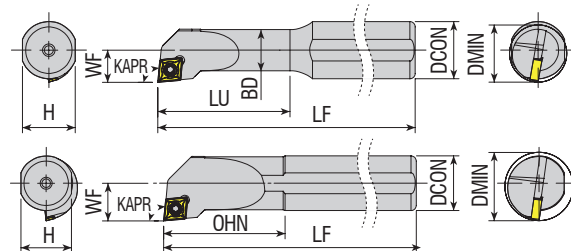

Takım Kodu
Ordering Code
Bestell-Bezeichnung

Stok Stock Lager	Takım Ölçüleri (mm) Dimension (mm) Abmessung (mm)								Kesici Uç Insert Wendeschneidplatte	Yedek Parçaları / Spare Parts / Ersatzteile				
	R	L	DCON	BD	H	LU=OHN	LF	WF		DMIN	Sıkma Vidası Screw Klemmschraube	Altık Shim Unterlage	Altık Vidası Shim Screw Schraube für Unterlage	Tork Anahtar Torx Key Torx Innensechskantschlüssel
S08H SCLCR/L 06	●	●	8	8	7.3	20	100	6	≥11	CC.. 0602..	4008-M2.5x6	-	-	82-T08
S10K SCLCR/L 06	●	●	10	10	9	25	125	7	≥13					
S12K SCLCR/L 06	●	●	12	12	11	25	125	9	≥16					
S16P SCLCR/L 09	●	●	16	16	14.8	35	170	11	≥20					

R: Sağ / Right / Rechts L: Sol / Left / Links

● Stokta / In Stock / Auf Lager ○ Stokta Yok / Non Stock Item / Kein Lagerartikel, Lieferzeit auf Anfrage

Sipariş Örneği/Ordering Example/Bestellbeispiel

1 ad./pcs./stück SET-A/SCLCR

SET-A/SDUCR/L

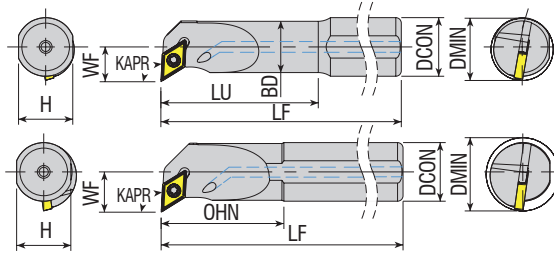

SDUCR

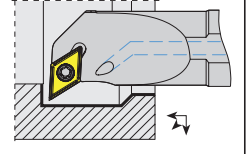

Takım Kodu
Ordering Code
Bestell-Bezeichnung

Takım Kodu Ordering Code Bestell-Bezeichnung	Stok Stock Lager	Takım Ölçüleri (mm) Dimension (mm) Abmessung (mm)							Kesici Uç Insert Wendeschneidplatte	Yedek Parçaları / Spare Parts / Ersatzteile				
		R	L	DCON	BD	H	LU=OHN	LF		WF	DMIN	Sıkma Vidası Screw Klemmschraube	Altlık Shim Unterlage	Altlık Vidası Shim Screw Schraube für Unterlage
A10H SDUCR/L 07	●●	10	10	09	25	100	08	≥13	DC.. 0702..	4008-M2.5x6	-	-	82-T08	
A12H SDUCR/L 07	●●	12	12	11	25	100	09	≥16						
A16M SDUCR/L 11	●●	16	16	14.8	35	150	11	≥20						DC.. 11T3..

SET-E/SDUCR/L

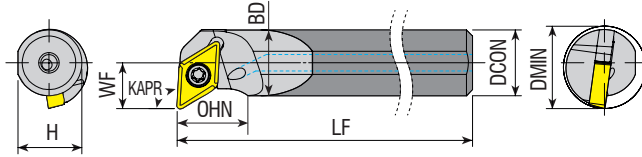

SDUCR

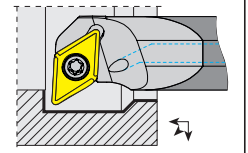

Takım Kodu
Ordering Code
Bestell-Bezeichnung

Takım Kodu Ordering Code Bestell-Bezeichnung	Stok Stock Lager	Takım Ölçüleri (mm) Dimension (mm) Abmessung (mm)							Kesici Uç Insert Wendeschneidplatte	Yedek Parçaları / Spare Parts / Ersatzteile				
		R	L	DCON	BD	H	OHN	LF		WF	DMIN	Sıkma Vidası Screw Klemmschraube	Altlık Shim Unterlage	Altlık Vidası Shim Screw Schraube für Unterlage
E10M SDUCR/L 07	●○	10	10	9.5	09	150	8	≥13	DC.. 0702..	4008-M2.5x6	-	-	82-T08	
E12Q SDUCR/L 07	●○	12	12	11	10	180	9	≥16						
E16R SDUCR/L 11	●○	16	16	15	12	200	11	≥20						DC.. 11T3..

SET-S/SDUCR/L

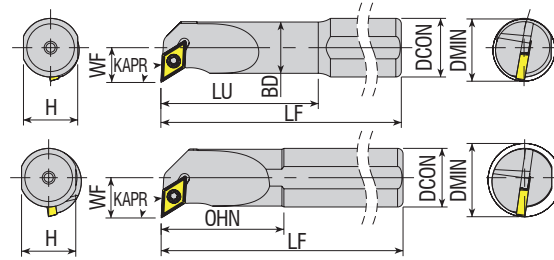

SDUCR

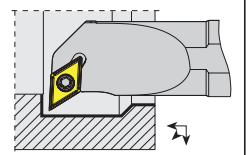

Takım Kodu
Ordering Code
Bestell-Bezeichnung

Takım Kodu Ordering Code Bestell-Bezeichnung	Stok Stock Lager	Takım Ölçüleri (mm) Dimension (mm) Abmessung (mm)							Kesici Uç Insert Wendeschneidplatte	Yedek Parçaları / Spare Parts / Ersatzteile				
		R	L	DCON	BD	H	LU=OHN	LF		WF	DMIN	Sıkma Vidası Screw Klemmschraube	Altlık Shim Unterlage	Altlık Vidası Shim Screw Schraube für Unterlage
S10K SDUCR/L 07	●●	10	10	9	25	125	8	≥13	DC.. 0702..	4008-M2.5x6	-	-	82-T08	
S12K SDUCR/L 07	●●	12	12	11	25	125	9	≥16						
S16P SDUCR/L 11	●●	16	16	14.8	35	170	11	≥20						DC.. 11T3..

R: Sağ / Right / Rechts L: Sol / Left / Links

● Stokta / In Stock / Auf Lager ○ Stokta Yok / Non Stock Item / Kein Lagerartikel, Lieferzeit auf Anfrage

Sipariş Örneği/Ordering Example/Bestellbeispiel

1 ad./pcs./stück SET-A/SDUCR



konusulan
the spoken kalite...
quality...

TIRLAMAZ

TIRLAMAZ TAKIMLAR
ANTIVIBRATION TOOLS
SCHWINGUNGSGEDÄMPFTE BOHRSTANGEN



AKKO **A** **TT** **B** **D16** **204** **10D** **H** **E**

2 Takım Tipi
Tool Type
Werkzeugtyp

Tırlamaz Takım
Anti Vibration Tool
Schwingungsgedämpfte Bohrstanze

8 Takım Malzemesi
Type of Boring Bar
Art der Bohrstanze

Karbür Takviyeli
Carbide reinforced
Hartmetall verstärkt

3 Gövde
Body
Schaft

4 Bağlantı Çapı
Connection Diameter
Anschlussdurchmesser

5 Takım Boyu
Overall length
Gesamtlänge

6 Bağlama Boyu
Overhang maximum
Maximale Auskragung

7 İçten Soğutmalı
With Coolant Hole
Mit Innenkühlung

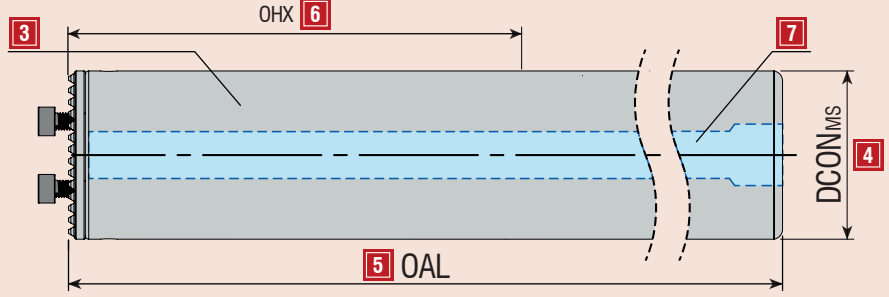

AKKO **A** **TT** **C** **A** **16** **SDUCR11**

2 Takım Tipi
Tool Type
Werkzeugtyp

Tırlamaz Takım Kartuşu
Anti Vibration Tool Cartridge
Wechselkopf für Schwingungsgedämpfte Bohrstanze

3 Kartuş Kodu
Cartridge Code
Bezeichnung für Wechselkopf

Kartuş
Cartridge
Wechselkopf

4 İçten Soğutmalı
With Coolant Hole
Mit Innenkühlung

5 Bağlama Çapı
Connection Diameter
Anschlussdurchmesser

Ø16 - Ø20 - Ø25
Ø32 - Ø40

2 Kartuş Tipi
Cartridge Type
Wechselkopftyp

SDUCR/L, SCLCR/L, SVUCR/L, TCLNR/L, TDUNR/L

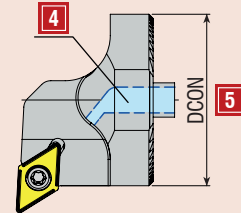

AKKO **A** **TT** **C** **16-25**

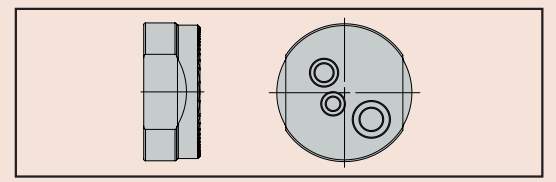

2 Takım Tipi
Tool Type
Werkzeugtyp

Tırlamaz Takım Kartuşu
Anti Vibration Tool Cartridge
Wechselkopf für Schwingungsgedämpfte Bohrstanzen

3 Kartuş
Cartridge
Wechselkopf

Merkeleme Kartuş Kodu
Centering Cartridge Code
Bezeichnung für zentriertes Wechselkopf

4 Kullanılan Gövde Çap Aralığı
Usable diameter range for body
Nutzbarer Durchmesserbereich für Werkzeugschaft

ATTB-D16/D20/D25
ATTB-D32/D40/D50/D60

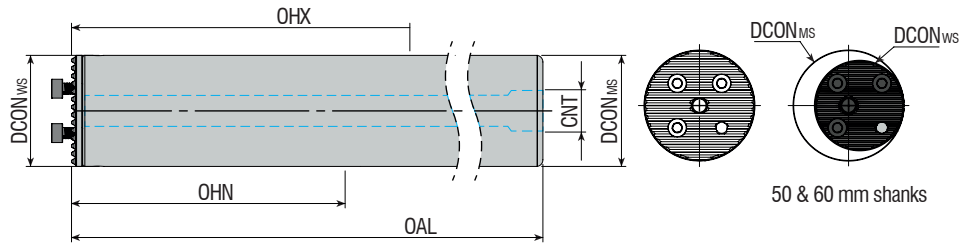

Takım Kodu Ordering Code Bestell-Bezeichnung	Stok Stock Lager	Takım Ölçüleri (mm) Dimension (mm) Abmessung (mm)							Yedek Parçaları / Spare Parts / Ersatzteile		
		DCONMS	DCONWS	OAL	OHN	OHX	CNT	Montaj Vidası Shim Screw Schraube für Unterlage		Montaj Vida Anahtar Mounting Screw Key Монтажный винт головой под шестигранник	
								DMIN	DCON		
ATTB-D16-156-7D-H	○	16	16	156	55	92	G1/8	16	20	2525-M3X10	AAL-02-2.5
ATTB-D16-204-10D-H-E	○	16	16	204	96	140	G1/8	16	20		
ATTB-D20-200-7D-H	○	20	20	200	70	120	G1/4	20	25		
ATTB-D20-260-10D-H-E	○	20	20	260	120	180	G1/4	20	25		
ATTB-D25-255-7D-H	●	25	25	255	88	158	G1/4	25	32	2503-M4X12	AAL-03-3
ATTB-D25-330-10D-H	○	25	25	330	155	230	G1/4	25	32		
ATTB-D32-320-7D-H	●	32	32	320	100	192	G3/8	32	40	2504-M5x12	AAL-05-4
ATTB-D32-416-10D-H	○	32	32	416	192	288	G3/8	32	40		
ATTB-D40-408-7D-H	●	40	40	408	128	248	G1/2	40	50	2505-M6X16	AAL-07-5
ATTB-D40-528-10D-H	○	40	40	528	248	368	G1/2	40	50		
ATTB-D50-519-7D-H	●	50	40	519	168	318	G1/2	40	63		
ATTB-D50-669-10D-H	○	50	40	669	318	468	G1/2	40	63		
ATTB-D60-628-7D-H	●	60	40	628	208	388	G3/4	40	80		
ATTB-D60-808-10D-H	○	60	40	808	388	568	G3/4	40	80		

R: Sağ / Right / Rechts L: Sol / Left / Links

● Stokta / In Stock / Auf Lager ○ Stokta Yok / Non Stock Item / Kein Lagerartikel, Lieferzeit auf Anfrage

Sipariş Örneği/Ordering Example/Bestellbeispiel

1 ad./pcs./stück ATTB-D16-156-7D-H



KAPR=93°

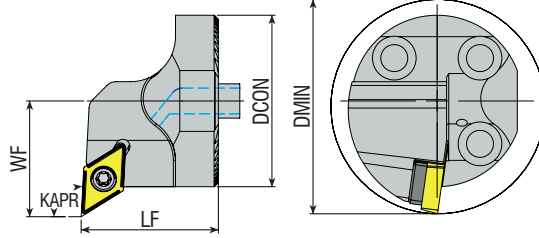

SDUCR

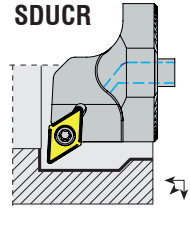

Takım Kodu
Ordering Code
Bestell-Bezeichnung

Stok Stock Lager	Takım Ölçüleri (mm) Dimension (mm) Abmessung (mm)					Kesici Uç Insert Wendeschneidplatte	Sıkma Vidası Screw Klemmschraube	Yedek Parçaları / Spare Parts / Ersatzteile			Bağlantı Parçası Connection Part	Tork Anahtar Torx Key Torx Innensechskantschlüssel
	R	L	DCON	LF	WF			Altık Shim Unterlage	Altık Vidası Shim Screw Schraube für Unterlage			
ATTC-A16 SDUCR/L 07	●	●	16	20	11	20	DC.. 0702..	4008-M2.5x6	-	-	ACP-02	82-T08
ATTC-A20 SDUCR/L 11	●	●	20	20	13	25	DC.. 11T3..	4015-M3.5x11	-	-	ACP-01	80-T15
ATTC-A25 SDUCR/L 11	●	●	25	23	17	32		4015-M3.5x12	AADN-2-0001	AAV-08-M3.5x8		
ATTC-A32 SDUCR/L 11	●	●	32	32	22	40	4015-M3.5x14	AAV-06-M3.5x11				
ATTC-A40 SDUCR/L 11	●	●	40	32	27	50						

KAPR=95°

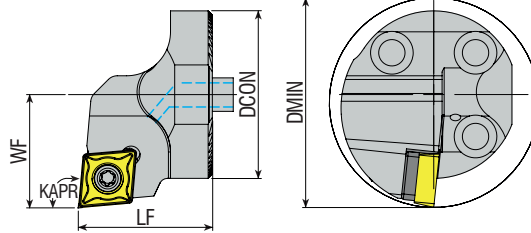

SCLCR

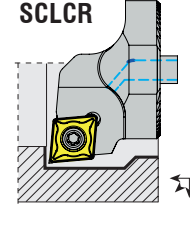

Takım Kodu
Ordering Code
Bestell-Bezeichnung

Stok Stock Lager	Takım Ölçüleri (mm) Dimension (mm) Abmessung (mm)					Kesici Uç Insert Wendeschneidplatte	Sıkma Vidası Screw Klemmschraube	Yedek Parçaları / Spare Parts / Ersatzteile			Bağlantı Parçası Connection Part Verbindungsstück	Tork Anahtar Torx Key Torx Innensechskantschlüssel
	R	L	DCON	LF	WF			Altık Shim Unterlage	Altık Vidası Shim Screw Schraube für Unterlage			
ATTC-A16 SCLCR/L 06	●	●	16	20	11	20	CC.. 0602..	4008-M2.5x6	-	-	ACP-02	82-T08
ATTC-A20 SCLCR/L 09	●	●	20	20	13	25	CC.. 09T3..	4015-M3.5x9	-	-	ACP-01	80-T15
ATTC-A25 SCLCR/L 09	●	●	25	23	17	32		4015-M3.5x12	AACN-2-0001	AAV-08-M3.5x8		
ATTC-A32 SCLCR/L 09	●	●	32	32	22	40	CC.. 1204..	4015-M3.5x12	AACN-2-0003	AAV-08-M3.5x8	ACP-01	80-T20
ATTC-A40 SCLCR/L 09	●	○	40	32	27	50		1020-M4.5x16				
ATTC-A40 SCLCR/L 12	●	●	40	32	27	50						

R: Sağ / Right / Rechts L: Sol / Left / Links

● Stokta / In Stock / Auf Lager ○ Stokta Yok / Non Stock Item / Kein Lagerartikel, Lieferzeit auf Anfrage

Sipariş Örneği/Ordering Example/Bestellbeispiel

1 ad./pcs./stück ATTC-A16-SDUCR 07

KAPR=93°

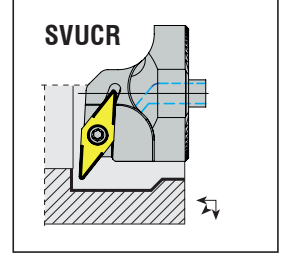
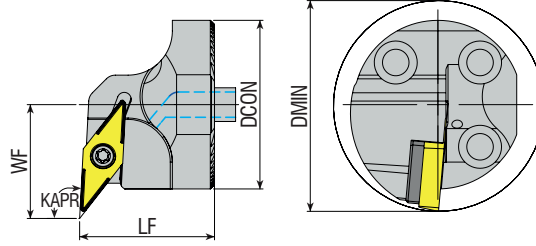

Takım Kodu
Ordering Code
Bestell-Bezeichnung

Stok Stock Lager	Takım Ölçüleri (mm) Dimension (mm) Abmessung (mm)					Kesici Uç Insert Wendeschneidplatte	Sıkma Vidası Screw Klemmschraube	Yedek Parçaları / Spare Parts / Ersatzteile				
	R	L	DCON	LF	WF			DMIN	Altık Shim Unterlage	Altık Vidası Shim Screw Schraube für Unterlage	Bağlantı Parçası Connection Part	Tork Anahtar Torx Key
ATTC-A20 SVUCR/L 11	●	●	20	20	15	27	VC.. 1103..	4008-M2.5x6	-	-	ACP-02	82-T08
ATTC-A25 SVUCR/L 11	●	●	25	23	17	32						
ATTC-A32 SVUCR/L 16	●	●	32	32	22	40	VC.. 1604..	4015-M3.5x14	AAVN-2-0002	AAV-06-M3.5x11	ACP-01	80-T15
ATTC-A40 SVUCR/L 16	●	●	40	32	27	50						

new

KAPR=90°

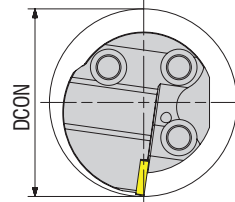
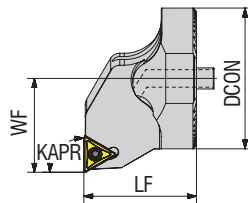

STFCR

Takım Kodu
Ordering Code
Bestell-Bezeichnung

Stok Stock Lager	Takım Ölçüleri (mm) Dimension (mm) Abmessung (mm)					Kesici Uç Insert Wendeschneidplatte	Sıkma Vidası Screw Klemmschraube	Yedek Parçaları / Spare Parts / Ersatzteile				
	R	L	DCON	LF	WF			DMIN	Altık Shim Unterlage	Altık Vidası Shim Screw Schraube für Unterlage	Bağlantı Parçası Connection Part	Tork Anahtar Torx Key
ATTC-A20 STFCR/L 11	○	●	20	20	13	25	TC.. 1102..	4008-M2.5x6	-	-	ACP-02	82-T08
ATTC-A40 STFCR/L 11	●	○	40	32	27	50					ACP-01	

R: Sağ / Right / Rechts L: Sol / Left / Links
● Stokta / In Stock / Auf Lager ○ Stokta Yok / Non Stock Item / Kein Lagerartikel, Lieferzeit auf Anfrage

Sipariş Örneği/Ordering Example/Bestellbeispiel
1 ad./pcs./stück ATTC-A20 SVUCR 11

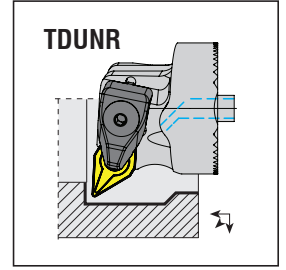
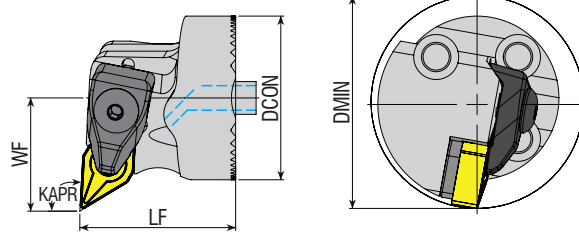

Takım Kodu Ordering Code Bestell-Bezeichnung	Yedek Parçaları / Spare Parts / Ersatzteile														
	Stok Stock Lager		Takım Ölçüleri (mm) Dimension (mm) Abmessung (mm)				Kesici Uç Insert Wendeschneidplatte	Baskı Pabuçu Wedge Clamp Spannpratze	Pabuç Vidası Clamp Screw Klemmschraube	Altlık Shim Unterlage	Altlık Vidası Shim Screw Schraube für Unterlage	Segman Ring Feder	Pul Stamp Ring	Bağlantı Parçası Connection Part	Tork Anahtar Torx Key Tor Innerschlüssel
	R	L	DCON	LF	WF	DMIN									
ATTC-A32 TDUNR/L 11	●	●	32	32	22	40	DN.. 1104..	ATK-01	AKV-01-M5x22	AADN -2-0001	AAV-04-M5x12	AS-01	ABPL-01	ACP-01	AAL-03-3
ATTC-A40 TDUNR/L 15	●	●	40	38	27	50	DN.. 1506..	ATK-02	AKV-30-M6x22	AADN -3-0001	AAV-02-M5x12				

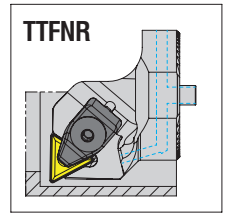
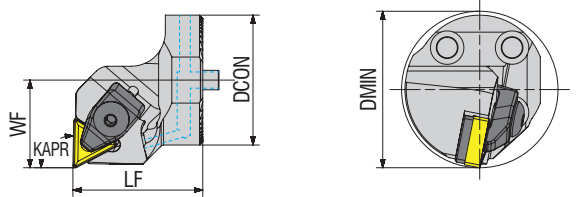

Takım Kodu Ordering Code Bestell-Bezeichnung	Yedek Parçaları / Spare Parts / Ersatzteile														
	Stok Stock Lager		Takım Ölçüleri (mm) Dimension (mm) Abmessung (mm)				Kesici Uç Insert Wendeschneidplatte	Baskı Pabuçu Wedge Clamp Spannpratze	Pabuç Vidası Clamp Screw Klemmschraube	Altlık Shim Unterlage	Altlık Vidası Shim Screw Schraube für Unterlage	Segman Ring Feder	Pul Stamp Ring	Bağlantı Parçası Connection Part Verbindungstück	Anahtar Allen Key Innerschlüssel
	R	L	DCON	LF	WF	DMIN									
ATTC-A40 TTFNR/L 16	○	●	40	27	27	50	TN.. 1604..	ATK-01	AKV-01-M5x22	AATN-2-0002	AAV-03-M5x12	-	ABPL-01	ACP-01	AAL-03-3

ISO Ucuna Uygundur. / Compatible with ISO Insert. / Kompatibel mit ISO Wendeplatten.

R: Sağ / Right / Rechts L: Sol / Left / Links

● Stokta / In Stock / Auf Lager ○ Stokta Yok / Non Stock Item / Kein Lagerartikel, Lieferzeit auf Anfrage

Sipariş Örneği/Ordering Example/Bestellbeispiel

1 ad./pcs./stück ATTC-A32 TDUNR 11

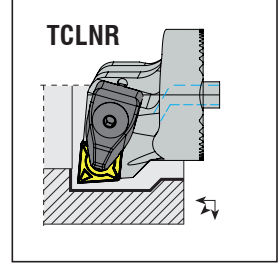
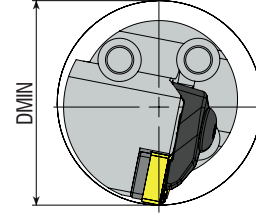
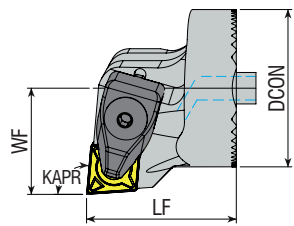

Takım Kodu Ordering Code Bestell-Bezeichnung	Stok Stock Lager		Takım Ölçüleri (mm) Dimension (mm) Abmessung (mm)				Kesici Uç Insert Wendeschneidplatte	Baskı Pabucu Wedge Clamp Spannpratze	Pabuç Vidası Clamp Screw Klemmschraube	Altlık Shim Unterlage	Altlık Vidası Schraube für Unterlage	Segman Ring Feder	Pul Stamp Ring	Bağlantı Parçası Connection Part	Anahtar Allen Key Innerschraubenschlüssel
	R	L	DCON	LF	WF	DMIN									
ATTC-A32 TCLNR/L 12	●	●	32	38	22	40	CN.. 1204..	ATK-02	AKV-30-M6x22	AACN -3-0001	AAV-02-M5x12	AS-01	ABPL-01	ACP-01	AAL-03-3
ATTC-A40 TCLNR/L 12	●	●	40	40	27	50									

TIRLAMAZ TAKIMLARIN MERKEZLEME APARATI
ANTI VIBRATION TOOLS CENTERING INSTRUMENT
ZENTRIERWERKZEUG FÜR SCHWINGUNGSGEDÄMPFTE BORSTANGE

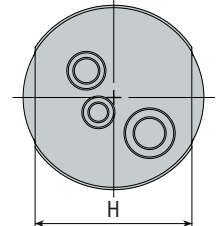
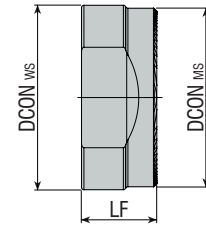

Takım Kodu Ordering Code Bestell-Bezeichnung	Stok Stock Lager	Takım Ölçüleri (mm) Dimension (mm) Abmessung (mm)				Gövde Tipi Booring Bars Борштанги
		DCONWS	DCONMS	LF	H	
ATTC-16-25	●	28	25	15	22	ATTB-D16/D20/D25
ATTC-32-60	●	53	40	20	35	ATTB-D32/D40/D50/D60

R: Sağ / Right / Rechts L: Sol / Left / Links
● Stokta / In Stock / Auf Lager ○ Stokta Yok / Non Stock Item / Kein Lagerartikel, Lieferzeit auf Anfrage

Sipariş Örneği/Ordering Example/Bestellbeispiel
1 ad./pcs./stück ATTC-A32 TCLNR 12

1 Montaj ve Ayarlama | Assembly and Adjusting | Montage und Einstellung

Kartuş ve gövdenin montaj edilecek yüzeyleri, tutucunun iç kısmı temizlenmelidir. Aşağıdaki görselde A ve B konularına bakın.

The surface of the cartridge and the shank to be mounted, as well as the inner part of the toolholder should be cleaned. Check A and B in the image below.

Die Oberflächen des Wechselkopfes und des zu montierenden Schafts sowie der innere Teil des Werkzeughalters sollten gereinigt werden. Siehe A und B unten auf der Abbildung

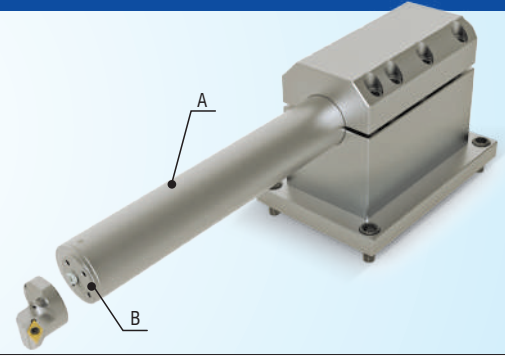

2 Gövde Montajı | Assembly for the Shank | Schaftmontage

Bağlama uzunluğu 4 L / D oranından az olmamalıdır. Tutucunun üst kısmını çıkartma yöntemiyle veya diğer tutma sıkma yöntemleriyle kullanmanızı öneririz (C tipi). Vidalı bağlama yöntemi kullanmayın. Uzun süre çalışırken lütfen içten soğutmayı kullanın.

The clamping length should not be less than 4 L/D ratio. Suggest using the clamping cover with opening method and other holding clamping methods. (Type C). Do not use screw clamping method. Use inner cooling please when working a long time.

Die Einspannlänge sollte nicht weniger als 4 L / D ratio betragen. Vorgeschlagen ist die Oberseite des Halters zu öffnen und andere Halte-Klemmethoden zu verwenden. (Typ C). Bitte nicht die Schraubklemmethode verwenden. Bei langer Nutzung, bitte die Innenkühlung verwenden.

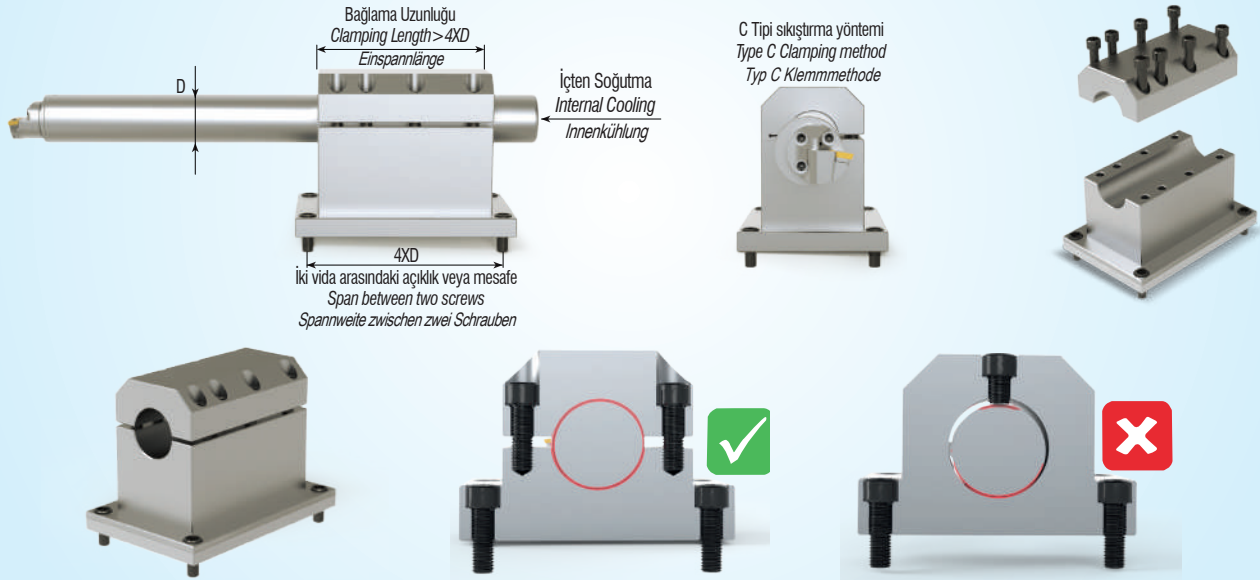

3 Merkez Yüksekliğinin Ayarlanması | Adjusting the Height of Centre Assembly | Einstellung der Zentrumhöhe

Gövdeyi ilk kez montaj ederken merkez yüksekliği için özel kalibrasyon aparatı kullanılmalıdır. Önce gövdeyi tutucuya monte edin, ardından X ekseninde 0,01 tolerans içinde kalibre edin. Lütfen komparatör saati ile ayarlamayı yapın.

When mounting the body for the first time, a special calibration tool should be used for the center height. First mount the shank on the holder, then calibrate it within 0.01 tolerance on the X axis direction. Please make the adjustment with the dial indicator device.

Bei der erstmaligen Montage des Schaftes sollte ein spezielles Kalibrierwerkzeug für die Zentrumhöhe verwendet werden. Montieren Sie zuerst den Schaft am Halter und kalibrieren Sie es dann innerhalb einer Toleranz von 0,01 in Richtung der X-Achse. Bitte benutzen Sie bei der Einstellung eine Messuhr

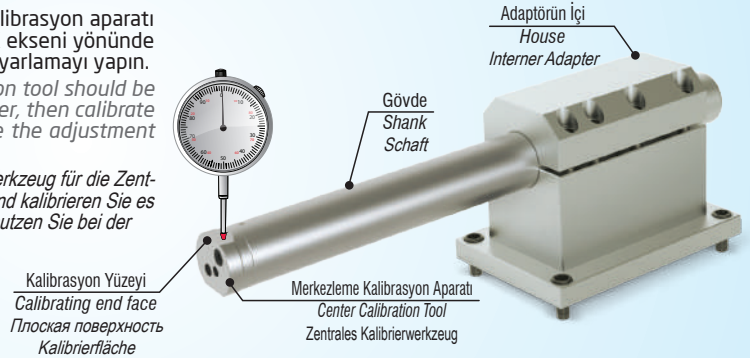

4 Doğru Kartuş Montajı | Assembly the Right Cartridge | Richtige Wechselkopfmontage

Yandaki şekle bakın:
See the figure on the side:
Siehe die Abbildung auf der Seite:

Sol Yön Takım
Left Hand
Linke Richtung



Sağ Yön Takım
Right Hand
Rechte Richtung



Doğru Uç Seçimi / Choosing the Correct Insert / Auswahl der richtigen Wendeschneidplatte

Doğru kesici ucun seçilmesi, titreşim sönümlenimin genel başarısı üzerinde büyük bir etkiye sahiptir. Kesici ucun işleme stabilitesini artırabilmesinin ana yolu kesme kuvvetlerini en aza indirmektir. Titreşimleri ortadan kaldırmak için aşağıdaki adımlara uymanız gerekir: Mümkünse, her zaman kısa takımları kullanın. Aksi takdirde, titreşimi en aza indirmek için hızlarınızı azaltın.

Choosing the correct insert can have a big influence on the overall success of vibration damping. The main way the insert can improve the machining stability is by minimizing the cutting forces. Following the guidelines below should be your first step to eliminate vibrations: If possible, use it always short drilling tools. Otherwise, reduce your speeds to minimize vibration.

Die Auswahl des richtigen Einsatzes kann einen großen Einfluss auf den Gesamterfolg der Schwingungsdämpfung haben. Die Wendeschneidplatte kann die Bearbeitungsstabilität hauptsächlich durch Minimierung der Schneidkräfte verbessern. Das Befolgen der folgenden Richtlinien sollte Ihr erster Schritt sein, um Vibrationen zu beseitigen: Verwenden Sie nach Möglichkeit immer kurze Werkzeuge. Reduzieren Sie andernfalls die Geschwindigkeit, um Vibrationen zu minimieren.

A Radyal kuvvetleri minimuma indirmek için mümkün olduğunca 90°'ye yakın bir giriş açılı takımı seçin.

Choose an entry angle that is as close as possible to 90° to reduce the radial forces to a minimum.

Wählen Sie einen Eintrittswinkel, der so nah wie möglich an 90° liegt, um die Radialkräfte auf ein Minimum zu reduzieren.

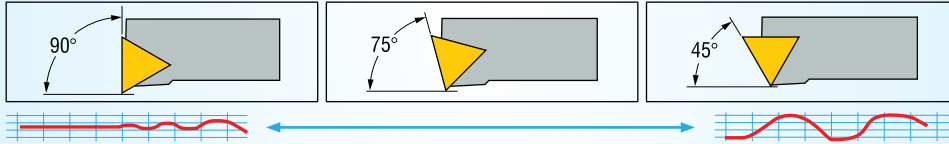

B Mümkün olan en küçük kesici uç açısını seçin. Böylece kesme kuvvetleri azalacak ve yüzey kalitesi artacak.

Choose the smallest insert head angle possible. This will reduce overall cutting forces and increase the clearance.

Wählen Sie den kleinstmöglichen Wendeschneidplattenwinkel. Damit wird sich die Gesamtschneidkraft verringern und die Klarheit verbessern.

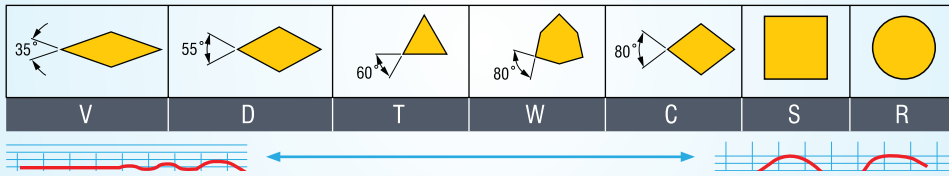

C Titreşimi azaltmak için olabildiğince en küçük radyüslü ucu seçmelisiniz.

Choose a small nose radius to reduce the cutting forces and to enable machining in a lower depth of cut.

Wählen Sie einen Eintrittswinkel, der so nah wie möglich an 90° liegt, um die Radialkräfte auf ein Minimum zu reduzieren.

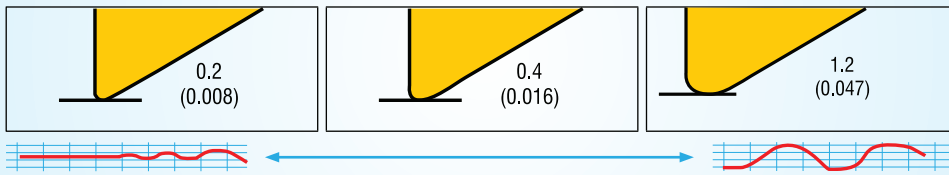

D İşleme derinliği (ap) radyüsten daha büyük olmalıdır.

Machining depth (ap) should be larger than the nose radius.

Die Bearbeitungstiefe (ap) sollte größer als der Schneideckenradius sein.

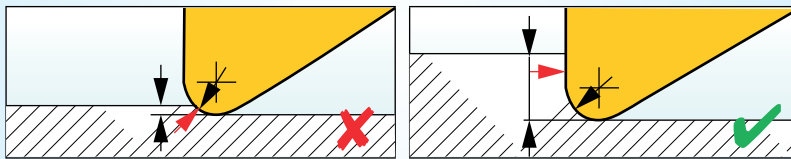

E Kesme kuvvetlerini azaltmak için daha pozitif geometriye sahip bir kesici uç kullanın:

Use an insert with an overall positive geometry to reduce the cutting forces:

Verwenden Sie eine Wendeschneidplatte mit insgesamt positiver Geometrie, um die Schneidkräfte zu reduzieren:

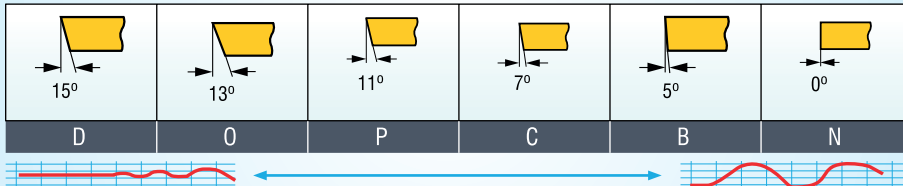

F Pozitif bir üst eğim geometrisi seçin:

Choose a positive top rake geometry:

Benutzen Sie einen positiven, oberen Spanwinkel:

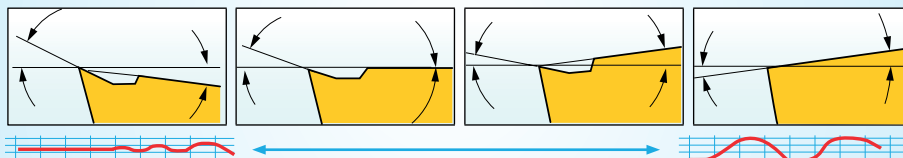

G For-dampened-straight-adaptor:

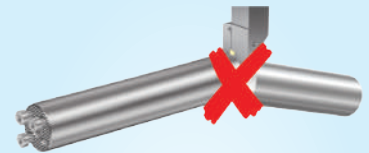

L, kesildikten sonra min uzunluk
L, min length after cut off
L, min Länge nach dem Abschneiden

Ø	Kısa Tasarım Short Design Kurzes Design 4-7x Ø (mm)	Uzun Tasarım Long Design Langes Design 7-10x Ø (mm)
16	100	155
20	125	200
25	155	255
32	190	320
40	240	410
50	305	520
60	380	630



Değiştirilebilir Uçlu Takımlar,
Takım Tutucu Sistemler ve Kesici Uçlar
Indexable Tools, Tool Holder Systems and Cutting Inserts
Zerspanungswerkzeuge, Werkzeugaufnahmen
und Zerspanungswerkzeuge

www.akko.com.tr

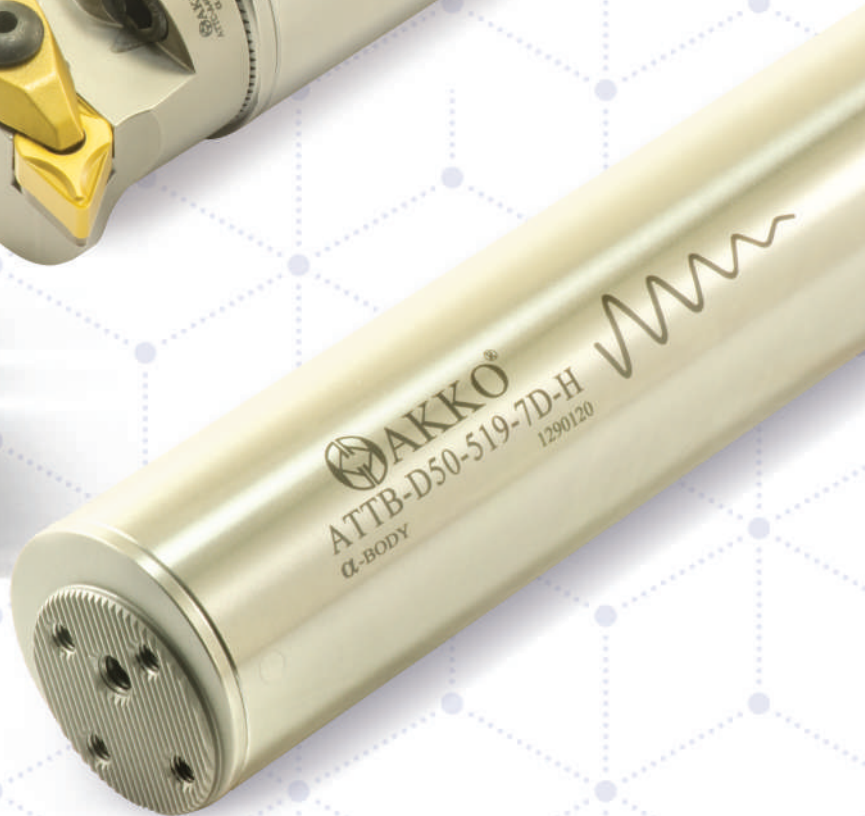

AKKO Metalworking Tools



*konusulan
the spoken kalite...
quality...*

KARTUŞLAR

KARTUŞLAR
CARTRIDGE
KURZDREHHALTER



S

1

T

2

F

3

C

4

R

5

12

6

C

7

A

8

16

9

1 Sıkma Tipi / Method of Mounting of Insert / Klemmsystem



Deliksiz Üstten Sıkma
Top Clamping Without Hole
Pratzenklemmung

C

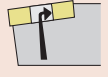

Delikten Levye ile Sıkma
Hole Clamping (Lever Lock)
Kniehebel-Spannsystem

P



Vida ile Sıkma
Screw on
Schrauben-Spannsystem

S

2 Uç Tipi / Type of Insert / Plattenform



C



S



T

3 Yanaşıma Açısı / Tool Holder Shape Bar Geometry / Anstellwinkel

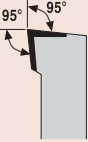

L



S

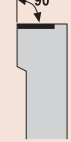

F

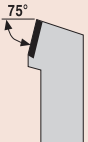

R



K



G



W



T

4 Serbest Uç Açısı / Insert Clearance Angle / Freiwinkel



C



P



N

5 Kesme Yönü / Cutting Direction / Halterausführung

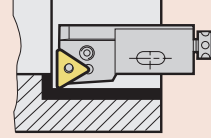

R

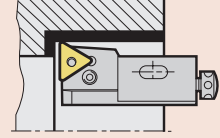

L

6 Kesme Kenar Yüksekliği / Cutting Edge Height / Drehhalterhöhe

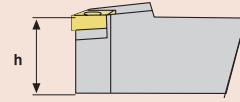

7 Kartuş Kodu / Cartridge Code / Wechselkopfbezeichnung

C

(Kartuş / Cartridge Code / Kurzdrehhalter Bezeichnung)

8 Kartuş Tipi / Cartridge Type / Wechselkopftyp

A

(ISO 5611)

9 Kesme Kenar Uzunluğu / Cutting Edge Length / Halterausführung

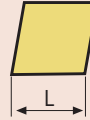

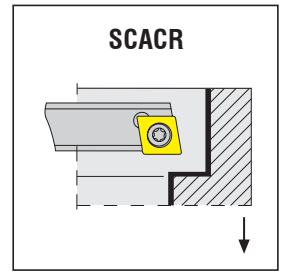
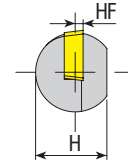
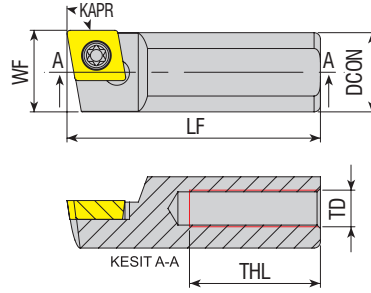

Takım Kodu Ordering Code Bestell-Bezeichnung	Stok Stock Lager		Takım Ölçüleri (mm) Dimension (mm) Abmessung (mm)							Kesici Uç Insert Wendeschneidplatte	Yedek Parçaları / Spare Parts / Ersatzteile	
	R	L	DCON	H	LF	THL	HF	WF	TD	Sıkma Vidası Screw Klemmschraube	Tork Anahtar Torx Key Torx Innensechskantschlüssel	
S10X SCACR/L 06	●	●	10	9	25	10	1	10.3	M5x0.8	CC.. 0602..	4008-M2.5x6	82-T08
S10A SCACR/L 06	●	●	10	9	32	15	1	10.3	M5x0.8			
S1018 SCACR/L 06	○	●	10	9	18	8	1	9.8	M5x0.8			
S1065 SCACR/L 06	○	●	10	9	65	25	1	10.3	M5x0.8			
S10C SCACR/L 06	●	●	10	9	50	25	1	10.3	M5x0.8			
S12B SCACR/L 06	●	●	12	11	40	25	1	12.3	M5x0.8			
S12D SCACR/L 06	●	●	12	11	60	25	1	12.3	M5x0.8			
S12D SCACR/L 09	●	●	12	11	60	25	2	12.3	M5x0.8			
S1265 SCACR/L 09	○	●	12	11	65	25	2	12.3	M5x0.8			
S12H SCACR/L 09	●	●	12	11	100	25	2	12.3	M5x0.8			
S15C SCACR/L 09	●	●	15	14	50	25	2	15.3	M8x1.25	CC.. 09T3..	4015-M3.5x8	80-T15
S1554 SCACR/L 09	○	●	15	14	54	25	2	15.3	M8x1.25			
S15E SCACR/L 09	○	●	15	14	70	45	2	15.3	M8x1.25			
S15D SCACR/L 09	○	●	15	14	60	30	2	15.3	M8x1.25			
S16A SCACR/L 09	●	●	16	15	32	15	2	16.5	M6x1			
S16B SCACR/L 09	●	●	16	15	40	20	2	16.5	M6x1			
S16C SCACR/L 09	○	●	16	15	50	25	2	16.5	M6x1			
S16D SCACR/L 09	●	●	16	15	60	30	2	16.5	M6x1			
S16E SCACR/L 09	○	●	16	15	70	30	2	16.5	M6x1			
S16G SCACR/L 09	●	●	16	15	90	30	2	16.5	M6x1			
S16H SCACR/L 09	○	●	16	15	100	35	4	16.5	M6x1			
S1868 SCACR/L 09	○	●	18	17	68	30	2	18.5	M8x1.25	CC.. 1204..	1020-M5x11	80-T20
S18E SCACR/L 09	●	●	18	17	70	30	2	18.5	M8x1.25			
S1888 SCACR/L 09	○	●	18	17	88	30	2	18.5	M8x1.25			
S18105 SCACR/L 09	○	●	18	17	105	30	2	18.5	M8x1.25			
S18175 SCACR/L 09	○	●	18	17	175	30	2	18.5	M8x1.25			
S20E SCACR/L 09	●	●	20	18.3	70	30	2	20.5	M6x1			
S20E SCACR/L 12	●	●	20	18.3	70	30	2	20.5	M6x1			
S20H SCACR/L 12	●	●	20	18.3	100	30	2	20.5	M6x1			

R: Sağ / Right / Rechts L: Sol / Left / Links
● Stokta / In Stock / Auf Lager ○ Stokta Yok / Non Stock Item / Kein Lagerartikel, Lieferzeit auf Anfrage

Sipariş Örneği/Ordering Example/Bestellbeispiel
1 ad./pcs./stück S10X SCACR 06

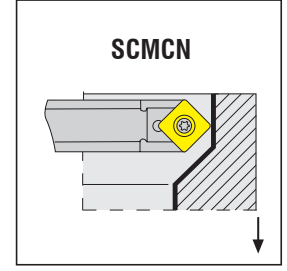
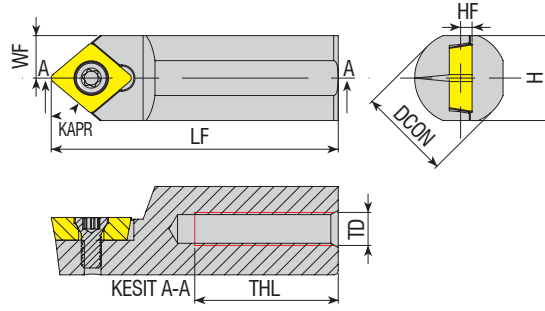

Takım Kodu Ordering Code Bestell-Bezeichnung	Stok Stock Lager	Takım Ölçüleri (mm) Dimension (mm) Abmessung (mm)							Kesici Uç Insert Wendeschneidplatte	Yedek Parçaları / Spare Parts / Ersatzteile	
		DCON	H	LF	THL	HF	WF	TD		Sıkma Vidası Screw Klemmschraube	Tork Anahtar Torx Key Torx Innensechskantschlüssel
S08A SCMCN 06	●	8	7	32	-	2	4	-	CC.. 0602..	4008-M2.5x6	82-T08
S10X SCMCN 06	●	10	9	25	10	1	4.5	M5x0.8			
S10A SCMCN 06	●	10	9	32	15	1	4.5				
S10B SCMCN 06	●	10	9	40	20	1	4.5				
S10C SCMCN 06	●	10	9	50	25	1	4.5				
S10D SCMCN 06	●	10	9	60	25	1	4.5				
S12D SCMCN 06	●	12	11	60	25	1	5.5				
S16C SCMCN 09	●	16	15	50	25	2	7.5	CC.. 09T3..	4015-M3.5x9 4015-M3.5x11	80-T15	
S16D SCMCN 09	●	16	15	60	25	4	7.5				M6x1

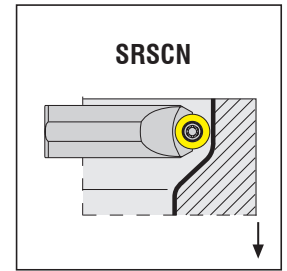
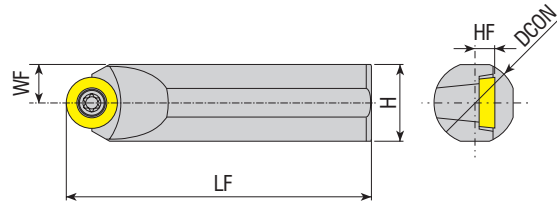

Takım Kodu Ordering Code Bestell-Bezeichnung	Stok Stock Lager	Takım Ölçüleri (mm) Dimension (mm) Abmessung (mm)					Kesici Uç Insert Wendeschneidplatte	Yedek Parçaları / Spare Parts / Ersatzteile	
		DCON	H	WF	HF	LF		Sıkma Vidası Screw Klemmschraube	Tork Anahtar Torx Key Torx Innensechskantschlüssel
S12D SRSCN 10	●	12	11	5.5	3.9	60	RC.. 10T3..	4015-M3.5x9	80-T15
S14D SRSCN 10	●	14	13	6.5	3.9	60		4015-M3.5x11	
S16D SRSCN 10	●	16	15	7.5	3.9	60			

R: Sağ / Right / Rechts L: Sol / Left / Links

● Stokta / In Stock / Auf Lager ○ Stokta Yok / Non Stock Item / Kein Lagerartikel, Lieferzeit auf Anfrage

Sipariş Örneği/Ordering Example/Bestellbeispiel

1 ad./pcs./stück S08A SCMCN 06

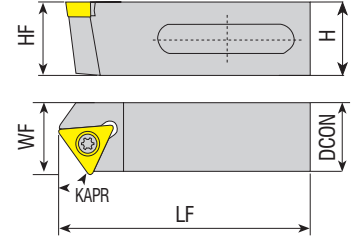

Takım Kodu Ordering Code Bestell-Bezeichnung	Stok Stock Lager		Takım Ölçüleri (mm) Dimension (mm) Abmessung (mm)					Kesici Uç Insert Wendeschneidplatte	Yedek Parçaları / Spare Parts / Ersatzteile		
	R	L	DCON	HF	H	LF	WF		Sıkma Vidası Screw Klemmschraube	Tork Anahtar Torx Key Torx Innensechskantschlüssel	
STXCR/L 2020 B16	○	●	20	20	20	45	20	TC.. 16T3..			
STXCR/L 2020 E16	○	●	20	20	20	70	20				
STXCR/L 2020 B16-SA	○	●	20	10	20	45	20				
STXCR/L 2020 E16-SA	○	●	20	10	20	70	20				
STXCR/L 2020 B16-PL	○	●	20	10	20	45	20				
STXCR/L 2020 E16-PL	○	●	20	10	20	70	20				
STXCR/L 2020 H16-PL	○	●	20	10	20	100	20				

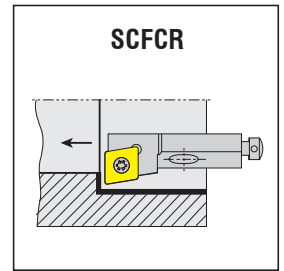
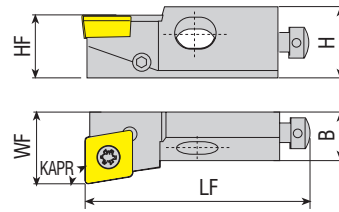
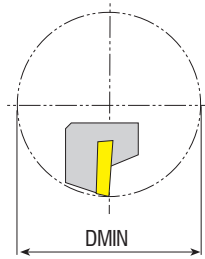

Takım Kodu Ordering Code Bestell-Bezeichnung	Stok Stock Lager		Takım Ölçüleri (mm) Dimension (mm) Abmessung (mm)						Kesici Uç Insert Wendeschneidplatte	Yedek Parçaları / Spare Parts / Ersatzteile			
	R	L	HF	H	B	LF	WF	DMIN		Altlık Shim Unterlage	Altlık Vidası Shim Screw Schraube für Unterlage	Sıkma Vidası Screw Klemmschraube	Tork Anahtar Torx Key Torx Innensechskantschlüssel
SCFCR/L 06CA 06	●	●	6	8.5	6	25	8	≥20	CC.T 060204	-	-	4008-M2.5x6	82-T08
SCFCR/L 08CA 06	●	●	8	11	8	32	10	≥25					
SCFCR/L 10CA 09	●	●	10	15	11	50	14	≥40	CC.T 09T308	-	-	4015-M3.5x9	80-T15
SCFCR/L 12CA 12	●	○	12	20	15	55	20	≥50					
SCFCR/L 16CA 12	●	●	16	21	20	63	25	≥60	CC.T 120408	AACN-2-0003	AAV-10-M4.5x8	4020-M4.5x12	80-T20

R: Sağ / Right / Rechts L: Sol / Left / Links

● Stokta / In Stock / Auf Lager ○ Stokta Yok / Non Stock Item / Kein Lagerartikel, Lieferzeit auf Anfrage

Sipariş Örneği/Ordering Example/Bestellbeispiel

1 ad./pcs./stück STXCR 2020 B16



KAPR=95°

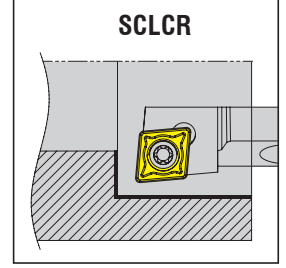
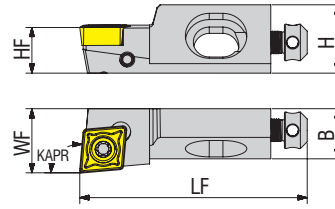
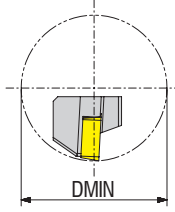

Takım Kodu Ordering Code Bestell-Bezeichnung	Stok Stock Lager		Takım Ölçüleri (mm) Dimension (mm) Abmessung (mm)					Kesici Uç Insert Wendeschneidplatte	Yedek Parçaları / Spare Parts / Ersatzteile				
	R	L	HF	H	B	LF	WF		DMIN	Altlık Shim Unterlage	Altlık Vidası Shim Screw Schraube für Unterlage	Sıkma Vidası Screw Klemmschraube	Tork Anahtar Torx Key Torx Innensechskantschlüssel
SCLCR/L 08CA 06	●	○	8	11	7.5	32	10	≥25	CC.T 060204	-	-	4008-M2.5x6	82-T08
SCLCR/L 10CA 09	●	○	10	15	11	50	14	≥40	CC.T 09T308	-	-	4015-M3.5x9	80-T15
SCLCR/L 12CA 09	●	○	12	20	15	55	20	≥50	CC.T 120408	-	-	4015-M3.5x11	80-T15
SCLCR/L 12CA 12	●	○	12	20	15	55	20	≥50	CC.T 120408	-	-	1020-M5x11	80-T20

ISO Ucuna Uygundur. / Compatible with ISO Insert. / Kompatibel mit ISO Wendeplatten.

KAPR=45°

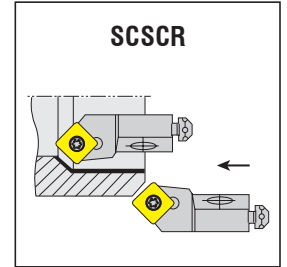
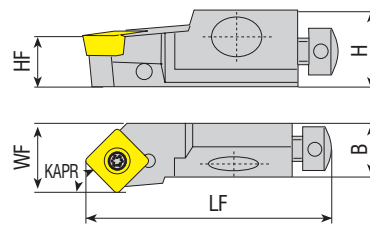
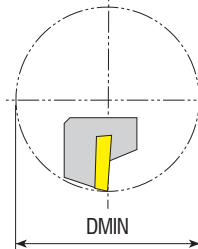

Takım Kodu Ordering Code Bestell-Bezeichnung	Stok Stock Lager		Takım Ölçüleri (mm) Dimension (mm) Abmessung (mm)					Kesici Uç Insert Wendeschneidplatte	Yedek Parçaları / Spare Parts / Ersatzteile				
	R	L	HF	H	B	LF	WF		DMIN	Altlık Shim Unterlage	Altlık Vidası Shim Screw Schraube für Unterlage	Sıkma Vidası Screw Klemmschraube	Tork Anahtar Torx Key Torx Innensechskantschlüssel
SCSCR/L 06CA 06	●	○	6	8	6	30	8	≥20	CC.T 060204	-	-	4008-M2.5x6	82-T08
SCSCR/L 10CA 09	●	○	10	15	11	50	14	≥40	CC.T 09T308	-	-	4015-M3.5x9	80-T15
SCSCR/L 12CA 12	○	○	12	20	15	55	20	≥50	CC.T 120408	-	-	1020-M5x11	80-T20

R: Sağ / Right / Rechts L: Sol / Left / Links

● Stokta / In Stock / Auf Lager ○ Stokta Yok / Non Stock Item / Kein Lagerartikel, Lieferzeit auf Anfrage

Sipariş Örneği/Ordering Example/Bestellbeispiel

1 ad./pcs./stück SCLCR 08CA 06

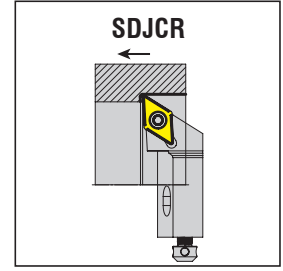
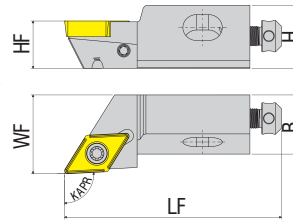
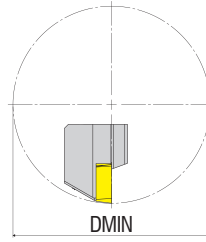

Takım Kodu Ordering Code Bestell-Bezeichnung	Stok Stock Lager		Takım Ölçüleri (mm) Dimension (mm) Abmessung (mm)					Kesici Uç Insert Wendeschneidplatte	Yedek Parçaları / Spare Parts / Ersatzteile				
	R	L	HF	H	B	LF	WF		DMIN	Altlık Shim Unterlage	Altlık Vidası Shim Screw Schraube für Unterlage	Sıkma Vidası Screw Klemmschraube	Tork Anahtar Torx Key Torx Innensechskantschlüssel
SDJCR/L 10CA 07	●	○	10	15	11	50	14	≥40					
SDJCR/L 12CA 11	●	○	12	16	15	55	20	≥50		-	-	4008-M2.5x6	82-T08
												4015-M3.5x10	80-T15

ISO Ucuna Uygundur. / Compatible with ISO Insert. / Kompatibel mit ISO Wendeplatten.

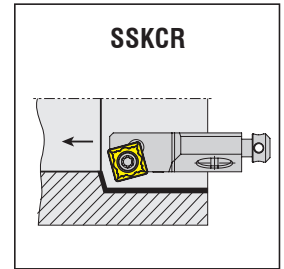
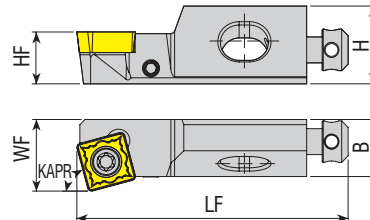
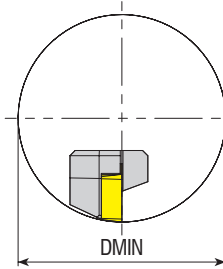

Takım Kodu Ordering Code Bestell-Bezeichnung	Stok Stock Lager		Takım Ölçüleri (mm) Dimension (mm) Abmessung (mm)					Kesici Uç Insert Wendeschneidplatte	Yedek Parçaları / Spare Parts / Ersatzteile				
	R	L	HF	H	B	LF	WF		DMIN	Altlık Shim Unterlage	Altlık Vidası Shim Screw Schraube für Unterlage	Sıkma Vidası Screw Klemmschraube	Tork Anahtar Torx Key Torx Innensechskantschlüssel
SSKCR/L 10CA 09	●	○	10	15	11	50	14	≥40					
SSKCR/L 12CA 12	●	○	12	20	15	55	20	≥50		-	-	4015-M3.5x9	80-T15
												1020-M5x11	80-T20

R: Sağ / Right / Rechts L: Sol / Left / Links

● Stokta / In Stock / Auf Lager ○ Stokta Yok / Non Stock Item / Kein Lagerartikel, Lieferzeit auf Anfrage

Sipariş Örneği/Ordering Example/Bestellbeispiel

1 ad./pcs./stück SDJCR 10CA 07

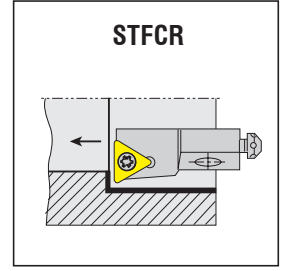
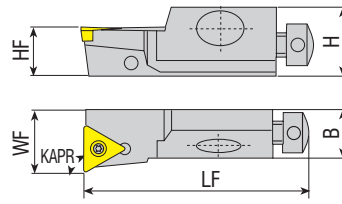
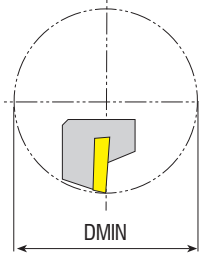

Takım Kodu Ordering Code Bestell-Bezeichnung	Stok Stock Lager		Takım Ölçüleri (mm) Dimension (mm) Abmessung (mm)					Kesici Uç Insert Wendeschneidplatte	Yedek Parçaları / Spare Parts / Ersatzteile				
	R	L	HF	H	B	LF	WF		DMIN	Altık Shim Unterlage	Altık Vidası Shim Screw Schraube für Unterlage	Sıkma Vidası Screw Klemmschraube	Tork Anahtar Torx Key Torx Innensechskantschlüssel
STFCR/L 08CA 09	●	●	8	11	8	32	10	≥25	TC.T 090204	-	-	3007-M2.2x4.6	82-T07
STFCR/L 10CA 11	●	●	10	15	11	50	14	≥40	TC.T 110204	-	-	4008-M2.5x6	82-T08
STFCR/L 12CA 16	●	○	12	20	15	55	20	≥50	TC.T 16T308	-	-	4015-M3.5x11	80-T15
STFCR/L 16CA 16	●	●	16	21	20	63	25	≥60		AATN-2-0001	AAV-06-M3.5x11	4015-M3.5x14	

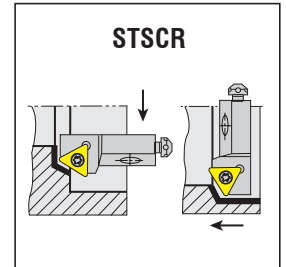
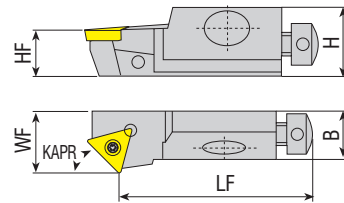
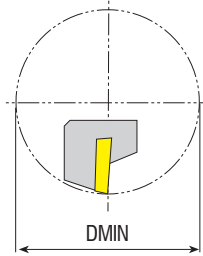

Takım Kodu Ordering Code Bestell-Bezeichnung	Stok Stock Lager		Takım Ölçüleri (mm) Dimension (mm) Abmessung (mm)					Kesici Uç Insert Wendeschneidplatte	Yedek Parçaları / Spare Parts / Ersatzteile				
	R	L	HF	H	B	LF	WF		DMIN	Altık Shim Unterlage	Altık Vidası Shim Screw Schraube für Unterlage	Sıkma Vidası Screw Klemmschraube	Tork Anahtar Torx Key Torx Innensechskantschlüssel
STSCR/L 08CA 09	●	○	8	11	8	28	10	≥25	TC.T 090204	-	-	3007-M2.2x4.6	82-T07
STSCR/L 10CA 11	●	●	10	15	11	44	14	≥40	TC.T 110204	-	-	4008-M2.5x6	82-T08
STSCR/L 12CA 16	●	○	12	20	15	47	20	≥50	TC.T 16T308	-	-	4015-M3.5x11	80-T15

R: Sağ / Right / Rechts L: Sol / Left / Links

● Stokta / In Stock / Auf Lager ○ Stokta Yok / Non Stock Item / Kein Lagerartikel, Lieferzeit auf Anfrage

Sipariş Örneği/Ordering Example/Bestellbeispiel

1 ad./pcs./stück STFCR 08CA 09

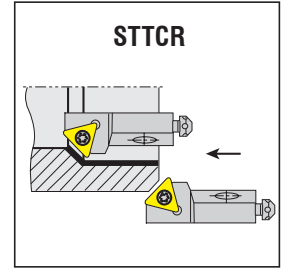
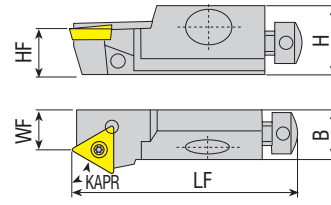
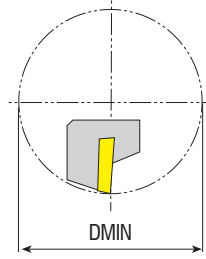

Takım Kodu Ordering Code Bestell-Bezeichnung	Stok Stock Lager		Takım Ölçüleri (mm) Dimension (mm) Abmessung (mm)					Kesici Uç Insert Wendeschneidplatte	Yedek Parçaları / Spare Parts / Ersatzteile				
	R	L	HF	H	B	LF	WF		DMIN	Altlık Shim Unterlage	Altlık Vidası Shim Screw Schraube für Unterlage	Sıkma Vidası Screw Klemmschraube	Tork Anahtar Torx Key Torx Innensechskantschlüssel
STTCR/L 08CA 09	●	●	8	11	8	32	6	≥25	TC.T 090204	-	-	3007-M2.2x4.6	82-T07
STTCR/L 10CA 11	●	●	10	15	11	50	9	≥40	TC.T 110204	-	-	4008-M2.5x6	82-T08
STTCR/L 12CA 16	●	○	12	20	14.8	55	20	≥50	TC.T 16T308	-	-	4015-M3.5x9	80-T15

R: Sağ / Right / Rechts L: Sol / Left / Links

● Stokta / In Stock / Auf Lager ○ Stokta Yok / Non Stock Item / Kein Lagerartikel, Lieferzeit auf Anfrage

Sipariş Örneği/Ordering Example/Bestellbeispiel

1 ad./pcs./stück STTCR 08CA 09



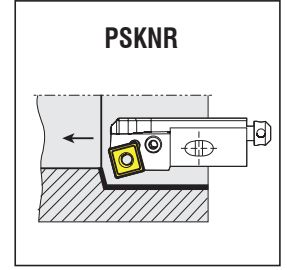
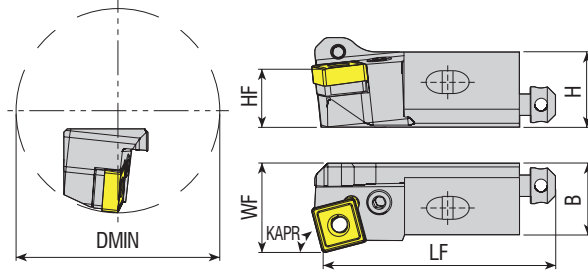

Takım Kodu Ordering Code Bestell-Bezeichnung	Stok Stock Lager		Takım Ölçüleri (mm) Dimension (mm) Abmessung (mm)					Kesici Uç Insert Wendeschneidplatte	Yedek Parçaları / Spare Parts / Ersatzteile					
	R	L	HF	H	B	LF	WF		DMIN	Levyeye Lever Kniehebel	Levyeye Vidası Lever Screw Kniehebelschraube	Altılık Shim Unterlage	Altılık Yayı Shim Spring Feder für Unterlage	Anahtar Allen Key Innensechskantschlüssel
PSKNR/L 16CA 12	●	●	16	21	20	63	25	≥60						
new PSKNR/L 20CA 15	●	●	20	30	20	70	25	-						

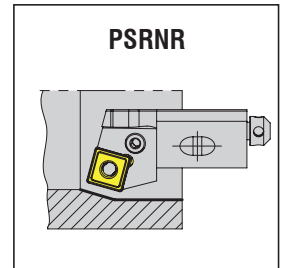
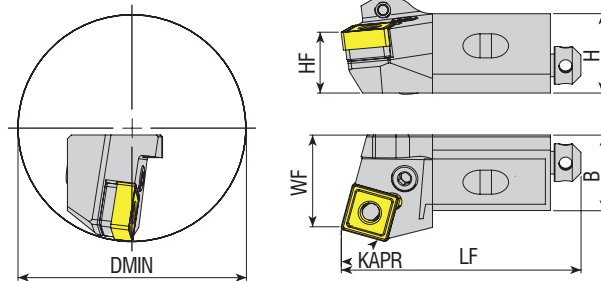

Takım Kodu Ordering Code Bestell-Bezeichnung	Stok Stock Lager		Takım Ölçüleri (mm) Dimension (mm) Abmessung (mm)					Kesici Uç Insert Wendeschneidplatte	Yedek Parçaları / Spare Parts / Ersatzteile					
	R	L	HF	H	B	LF	WF		DMIN	Levyeye Lever Kniehebel	Levyeye Vidası Lever Screw Kniehebelschraube	Altılık Shim Unterlage	Altılık Yayı Shim Spring Feder für Unterlage	Anahtar Allen Key Innensechskantschlüssel
PSRNR/L 16CA 12	○	●	16	21	20	63	25	≥60						

R: Sağ / Right / Rechts L: Sol / Left / Links

● Stokta / In Stock / Auf Lager ○ Stokta Yok / Non Stock Item / Kein Lagerartikel, Lieferzeit auf Anfrage

Sipariş Örneği/Ordering Example/Bestellbeispiel

1 ad./pcs./stück PSKNR 16CA 12

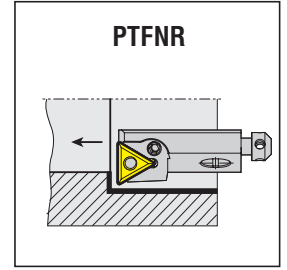
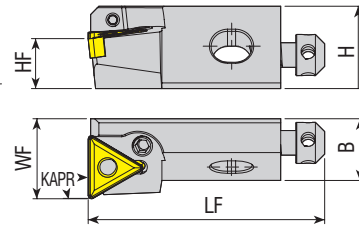
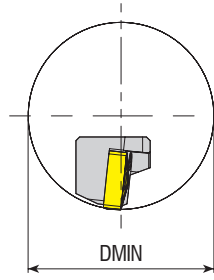

Takım Kodu Ordering Code Bestell-Bezeichnung	Stok Stock Lager		Takım Ölçüleri (mm) Dimension (mm) Abmessung (mm)						Kesici Uç Insert Wendeschneidplatte	Yedek Parçaları / Spare Parts / Ersatzteile				
	R	L	HF	H	B	LF	WF	DMIN		Levyé Lever Kniehebel	Levyé Vidası Lever Screw Kniehebelschraube	Altılık Shim Unterlage	Altılık Yayı Shim Spring Feder für Unterlage	Anahtar Allen Key Innerschloßschlüssel
PTFNR/L 12CA 16	●	●	12	20	15	47	20	≥50	TNM.160408	APL-08	ALV-07-M6x13	-	AAV-07	AAL-02-2.5
PTFNR/L 16CA 16	●	○	16	21	20	63	25	≥60		APL-01	ALV-01-M6x14	AATN-3-0025	AAV-01	
PTFNR/L 16CA 22	○	●	16	21	20	63	25	≥60	TNMG 2204.	APL-02	ALV-03-M8x19	AATN-3-0015	AAV-02	AAL-03-3
PTFNR/L 20CA 22	●	○	20	30	20	63	25	≥70						

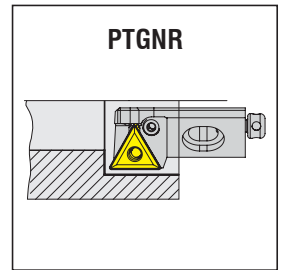
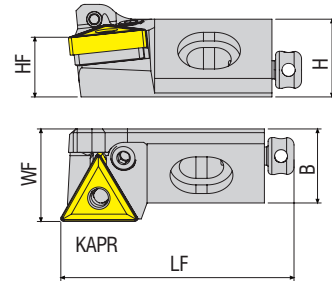
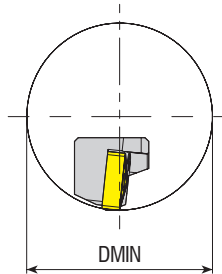

Takım Kodu Ordering Code Bestell-Bezeichnung	Stok Stock Lager		Takım Ölçüleri (mm) Dimension (mm) Abmessung (mm)						Kesici Uç Insert Wendeschneidplatte	Yedek Parçaları / Spare Parts / Ersatzteile				
	R	L	HF	H	B	LF	WF	DMIN		Levyé Lever Kniehebel	Levyé Vidası Lever Screw Kniehebelschraube	Altılık Shim Unterlage	Altılık Yayı Shim Spring Feder für Unterlage	Anahtar Allen Key Innerschloßschlüssel
PTGNR/L 16CA 22	●	●	16	21	20	63	25	60	TNMG 2204..	APL-02	ALV-03-M8x19	AATN-3-0015	AAV-02	AAL-03-3

R: Sağ / Right / Rechts L: Sol / Left / Links

● Stokta / In Stock / Auf Lager ○ Stokta Yok / Non Stock Item / Kein Lagerartikel, Lieferzeit auf Anfrage

Sipariş Örneği/Ordering Example/Bestellbeispiel

1 ad./pcs./stück PTFNR 12CA 16

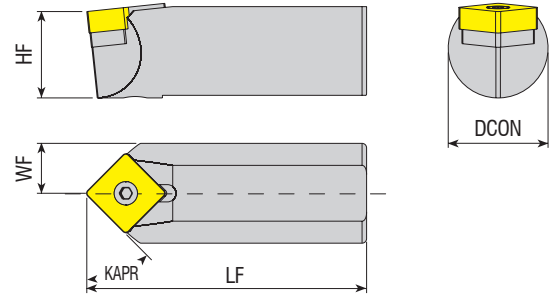

Takım Kodu Ordering Code Bestell-Bezeichnung	Stok Stock Lager	Takım Ölçüleri (mm) Dimension (mm) Abmessung (mm)				Kesici Uç Insert Wendeschneidplatte	Yedek Parçaları / Spare Parts / Ersatzteile				
		DCON	HF	LF	WF		Aitlik Shim Unterlage	Sıkma Vidası Screw Klemmschraube	Baskı Parçası Wedge Clamp Spannpratze	Baskı Vidası Clamp Screw Klemmschraube	Anahtar Allen Key Innensechskantschlüssel
S22D PSDNN 12C	●	22	17.5	65	11	SN.. 1204..	AASN-20020	AEV-01-M6x16	ACK-05	4015-M4x11	AAL-02-2.5

R: Sağ / Right / Rechts L: Sol / Left / Links

● Stokta / In Stock / Auf Lager ○ Stokta Yok / Non Stock Item / Kein Lagerartikel, Lieferzeit auf Anfrage

Sipariş Örneği/Ordering Example/Bestellbeispiel
1 ad./pcs./stück S22D PSDNN 12C

KARTUŞLARIN YEDEK PARÇALARI
SPARE PARTS OF CARTRIDGE
ERSATZTEILE FÜR KURZDREHHALTER

Takım Kodu Ordering Code Bestell-Bezeichnung	Yedek Parçaları / Spare Parts / Ersatzteile					
	Eksenel Ayar Vida Axial Adj. Screw Axial-Einstellschraube	Radyal Ayar Vida Radial Adj. Screw Radial-Einstellschraube	Radyal Ayar Vida Anahtar Radial Adj. Screw Allen Key Innensechskantschlüssel für Radial-Einstellschraube	Montaj Vida Mounting Screw Befestigungsschraube	Montaj Vida Anahtar Mounting Screw Allen Key Innensechskantschlüssel für Befestigungsschraube	
SCFCR/L	06CA 06	2600-M4x9.5	2715-M3x5	AAL-09-1.5	AKV-23-M4x10	82-T15
SCSCR/L	08CA 06	2600-M4x9.5	2715-M3x5	AAL-09-1.5	AKV-23-M4x10	82-T15
SSKCR/L	10CA 09	2600-M5x13	2702-M4x10	AAL-01-2	2505-M6x16	AAL-03-3
	12CA 12	2600-M5x13	2702-M4x10	AAL-01-2	2505-M6x16	AAL-03-3
	16CA 12	2600-M6x18	2725-M5x12	AAL-02-2.5	2005-M8x25	AAL-07-5
STSCR/L	08CA 09	2600-M4x9.5	2715-M3x5	AAL-09-1.5	AKV-23-M4x10	82-T15
STTCR/L	10CA 11	2600-M5x13	2702-M4x10	AAL-01-2	2505-M6x16	AAL-03-3
STFCR/L	12CA 16	2600-M5x13	2702-M4x10	AAL-01-2	2505-M6x16	AAL-03-3
	16CA 16	2600-M6x18	2725-M5x12	AAL-02-2.5	2005-M8x25	AAL-07-5
PTFNR/L	12CA 16	2600-M5x13	2702-M4x4	AAL-01-2	2505-M6x16	AAL-03-3
PSKNR/L	16CA 16	2600-M6x18	2725-M5x6	AAL-02-2.5	2005-M8x25	AAL-07-5
PSRNR/L	16CA 12	2600-M6x18	2725-M5x6	AAL-02-2.5	2005-M8x25	AAL-07-5



Takım Kodu Ordering Code Bestell-Bezeichnung	Stok Stock Lager	Ölçü Aralığı (mm) Boring Range (mm) Bohrbereich (mm)					Kartuşlar Cartridge Kurzdrehhalter	Gövde Takım Kodu Body Tool Code Grundkörper-Bezeichnung	Teknik Çizim Technical Draw Technische Zeichnung
		D max		D min		Max (D dış-D iç) (D out-D in)			
		D iç D in	D dış D out	D iç D in	D dış D out				
ACPBT-1	●	27-52	52	18-36	36	27	ÖTG-K-120-20		
ACPBT-2	●	27-49	52	25-36	36	27			
ACPBT-3	●	48-75	75	41	42	27			
ACPBT-4	●	51-75	75	51	52	27			
ACPBT-5	●	22-35	35	22	23	27			
ACPBT-6	●	15-35	35	15	16	27			
ACPBT-7	●	49-53	75	32-36	36	27			
ACPBT-8	●	49	75	33-37	37	27			

Takım Kodu Ordering Code Bestell-Bezeichnung	Stok Stock Lager	Ölçü Aralığı (mm) Boring Range (mm) Bohrbereich (mm)					Kartuşlar Cartridge Kurzdrehhalter	Gövde Takım Kodu Body Tool Code Grundkörper-Bezeichnung	Teknik Çizim Technical Draw Technische Zeichnung
		D1		D2		Max (D dış-D iç) (D out-D in)			
		D max	D min	D max	D min				
ACPBT-9	●	38	24	15	1	-	ÖTG-K-120-20		
ACPBT-10	●	78	64	43	29	-			

R: Sağ / Right / Rechts L: Sol / Left / Links

● Stokta / In Stock / Auf Lager ○ Stokta Yok / Non Stock Item / Kein Lagerartikel, Lieferzeit auf Anfrage

Sipariş Örneği / Ordering Example / Bestellbeispiel

1 ad./pcs./stück ACPBT-1



*konusulan
the spoken kalite...
quality...*

DİŞ AÇMA

DİŞ AÇMA TAKIMLARI
THREADING TOOLHOLDERS
GEWINDE DREHHALTER

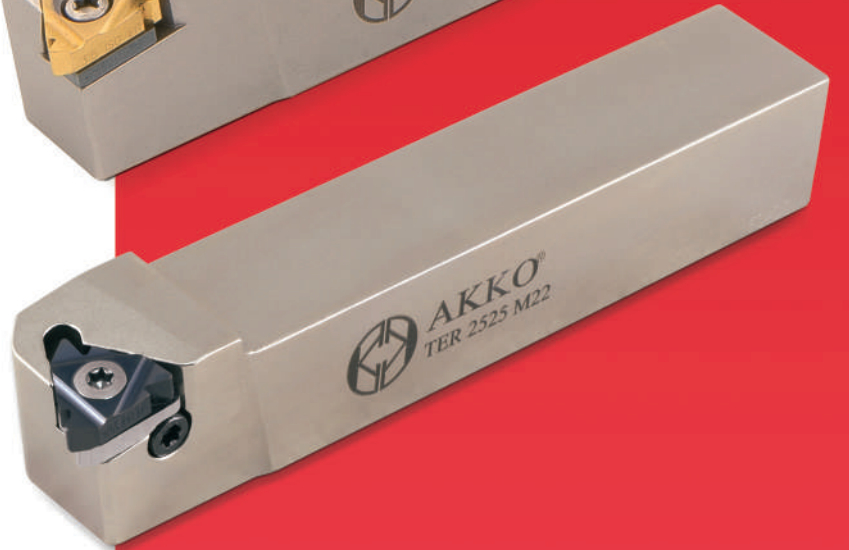



S **E** **R** **25 25** **M** **16** **C**

1 Sıkma Tipi / Method of Mounting of Insert
 Klemmsystem

S: Vida Sıkmalı
 S: Screw Clamping / S Schrauben-Spannsystem
 T: Vida Sıkmalı Helis Açılı
 T: Screw Clamping with Helix Angle
 T: Schraubenklemmung für unterschiedliche Einstellwinkel

2 İşlem Tipi / Application
 Anwendung

E: Dış / External
 Außen
 I: İç / Internal /
 Innen

3 Kesme Yönü
 Cutting Direction
 Halterausführung

R: Sağ Yan
 Right-Hand
 R: Rechts

L: Sol Yan
 Left-Hand
 L: Links

4 Takım Malzemesi / Type of Boring / Art der Bohrstanze

"A" Yekpare çelik gövde soğutma suyu kanallı / "A" Solid steel with coolant hole
 A" Stahlschaft mit Kühlbohrung SEITE 123
 "E" Çelik başlıkla sert metal gövde ve soğutma suyu kanallı / "E" Carbide bar with fixed steel head and coolant hole
 "E" Hartmetallstange mit festem Stahlkopf und Kühlmittelbohrung
 "C" Karbür Şaft / "C" Carbide shank / "C" Hartmetallschaft
 "S" Çelik Şaft / "S" Steel shank / "S" Stahlschaft

4-5 Dış Çap Şaft Ölçüleri / External Shank Size
 Äußere Schaftgröße

Şaft / Shank / Schaftausführung : hxb
 2525 - 25 x 25 mm

5 Şaft Çapı / Shank Diameter
 Schaft-Durchmesser

6 Şaft Boyu / Shank Length / Schaftlänge

A - 32	H - 100	Q - 180	x-special
B - 40	J - 110	R - 200	
C - 50	K - 125	S - 250	
D - 60	L - 140	T - 300	
E - 70	M - 150	U - 350	
F - 80	N - 160	V - 400	
G - 90	P - 170	W - 450	

7 Elmas Ölçüsü / Insert Size
 Wendeplattengröße

l (mm)	d
06	5/32"
08	3/16"
11	1/4"
16	3/8"
22	1/2"
27	5/8"

8 Baskı Pabucu
 Wedge Clamp
 Spannpratze

S **I** **R** **S** **25** **R** **16** **C**

DIŞ ÇAP DIŞ AÇMA KATERLERİ
EXTERNAL THREADING TOOLHOLDERS
AUSSEN-GEWINDEDREHHALTER

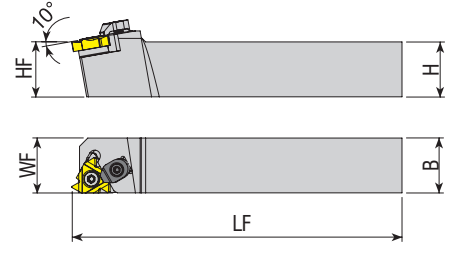
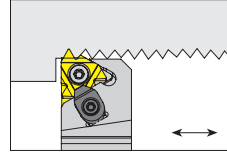

Takım Kodu Ordering Code Bestell-Bezeichnung	Stok Stock Lager		Takım Ölçüleri (mm) Dimension (mm) Abmessung (mm)				Kesici Uç Insert Wendeschneidplatte	Yedek Parçaları / Spare Parts / Ersatzteile					
	R	L	HF=H	B	LF	WF		Sıkma Vidası Screw Klemmschraube	Altlık Shim Unterlage	Altlık Vidası Shim Screw Schraube für Unterlage	Baskı Parçası Wedge Clamp Spannpratze	Baskı Vidası Clamp Screw Klemmschraube	Tork Anahtar Torx Key Torx Innensechskantschlüssel
SER/L 0808 E11	●	●	08	08	70	11	11 ER/EL	4008-M2.5x6	-	-	-	-	82-T08
SER/L 1010 E11	●	●	10	10	70	11							
SER/L 1212 F11	●	●	12	12	80	12							
SER/L 1616 H11	●	●	16	16	100	16	16 ER/EL (0.35 - 3) ISO METRIC	4015-M3.5x14	AATN-2-0020	AAV-06-M3.5x11	-	-	80-T15
SER/L 2020 H11	●	●	20	20	100	20							
SER/L 1616 H16C	●	●	16	16	100	16							
SER/L 2020 K16C	●	●	20	20	125	20	22 ER/EL (3.5 - 4.5) ISO METRIC	1020-M4.5x16	AATN-2-0004	AAV-07-M4.5x13	ACK-05	4015 M4x11	80-T20
SER/L 2525 M16C	●	●	25	25	150	25							
SER/L 3232 P16C	●	●	32	32	170	32							
SER/L 2525 M22C	●	●	25	25	150	25	16 ER/L (1.5-3 TR)	4015-M3.5x14	-	-	-	-	80-T15
SER/L 3232 P22C	●	●	32	32	170	32							
SER/L 4040 S22C	●	●	40	40	250	40							
SER/L 2525 M16C-T	●	●	25	25	150	25	22 ER/L (4-6 TR)	1020-M4.5x16	-	-	-	-	80-T20
SER/L 2020 K16C-S	●	●	20	20	125	25	SNDVK 166 ER/L16	4015-M3.5x14	AATN-2-0020	AAV-06-M3.5x11	-	-	80-T15
SER/L 2525 M16C-S	●	●	25	25	150	31							
SER/L 3232 P16C-S	●	●	32	32	170	38.5							

DIŞ ÇAP DIŞ AÇMA İSVİÇRE TİPİ KAYAR OTOMAT MAKİNA KATERLERİ
EXTERNAL THREADING TOOLHOLDERS FOR SWISS TYPE SLIDING AUTOMATIC LATHES
AUSSEN-GEWINDEDREHHALTER FÜR LANGDREHAUTOMATEN

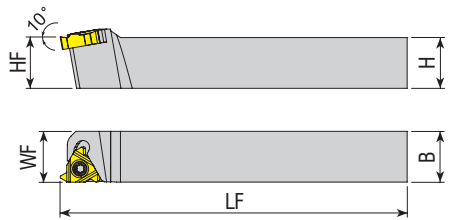
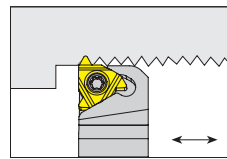

Takım Kodu Ordering Code Bestell-Bezeichnung	Stok Stock Lager		Takım Ölçüleri (mm) Dimension (mm) Abmessung (mm)				Kesici Uç Insert Wendeschneidplatte	Yedek Parçaları / Spare Parts / Ersatzteile					
	R	L	HF=H	B	LF	WF		Sıkma Vidası Screw Klemmschraube	Altlık Shim Unterlage	Altlık Vidası Shim Screw Schraube für Unterlage	Baskı Parçası Wedge Clamp Spannpratze	Baskı Vidası Clamp Screw Klemmschraube	Tork Anahtar Torx Key Torx Innensechskantschlüssel
SER/L 1010 K11-S	●	●	10	10	125	10	11 ER/EL	4008-M2.5x6	-	-	-	-	82-T08
SER/L 1212 K11-S	●	●	12	12	125	12							
SER/L 1212 K16-S	●	●	12	12	125	12							
SER/L 1212 K16-S	●	●	12	12	125	12	16 ER 3.5 (0.35 - 3)	4015-M3.5x14	AATN-2-0020	AAV-08-M3.5x8	-	-	80-T15

R: Sağ / Right / Rechts L: Sol / Left / Links ● Stokta / In Stock / Auf Lager ○ Stokta Yok / Non Stock Item / Kein Lagerartikel, Lieferzeit auf Anfrage
Takımlar standart 1.5° helis açılı olarak üretilir. / The tools have a built in 1.5° helix angle. / GEWINDE-DREHHALTER werden mit Einstellwinkel 1.5° hergestellt
UYARI / WARNING / ACHTUNG Sayfa 114'deki B ve D figürleri uygulanamaz. / The operation for B and D on page 114 can not be applied. / 114: für Abbildung B und D: nicht verwenden

Sipariş Örneği/Ordering Example/Bestellbeispiel
1 ad./pcs./stück SER 0808 E11

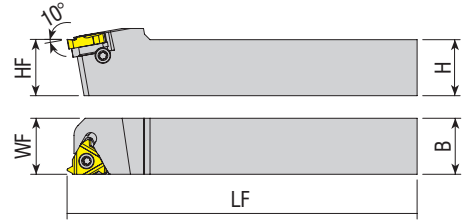
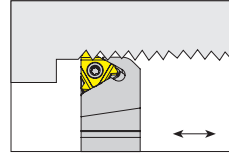
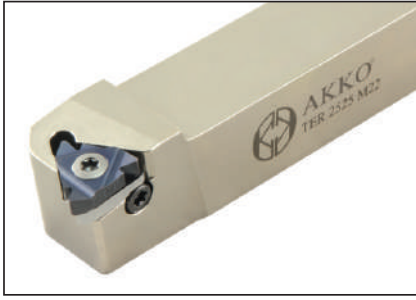

Takım Kodu Ordering Code Bestell-Bezeichnung	Stok Stock Lager		Takım Ölçüleri (mm) Dimension (mm) Abmessung (mm)				Kesici Uç Insert Wendeschneidplatte	Yedek Parçaları / Spare Parts / Ersatzteile					
	R	L	HF=H	B	LF	WF		Sıkma Vidası Screw Klemmschraube	Sağ Altlık Right Shim U-Platte für WSP rechts	Sol Altlık Left Shim U-Platte für WSP links	Altlık Vidası Shim Screw Schraube für Unterlage	Altlık Vidası Pulu Shim Screw Ring Schraube für Unterlagering	Tork Anahtar Torx Key Torx Innensechskantschlüssel
TER/L 1616 H16	●	●	16	16	100	16	16 ER/EL						
TER/L 2020 K16	●	●	20	20	125	20							
TER/L 2525 M16	●	●	25	25	150	25							
TER/L 3232 P16	●	●	32	32	170	32							
TER/L 2525 M22	●	●	25	25	150	25	22 ER/EL						
TER/L 3232 P22	●	●	32	32	170	32							
TER/L 4040 S22	●	●	40	40	250	40							
TER/L 2525 M27	●	●	25	25	150	25							
TER/L 3232 P27	●	●	32	32	170	32	27 ER/EL						
TER/L 4040 S27	●	●	40	40	250	40							

R: Sağ / Right / Rechts L: Sol / Left / Links ● Stokta / In Stock / Auf Lager ○ Stokta Yok / Non Stock Item / Kein Lagerartikel, Lieferzeit auf Anfrage
Takımlar standart 1.5° helis açılı olarak üretilir. / The tools have a built in 1.5° helix angle. / GEWINDE-DREHHALTER werden mit Einstellwinkel 1.5° hergestellt

Sipariş Örneği/Ordering Example/Bestellbeispiel
1 ad./pcs./stück TER 1616 H16

DIŞ ÇAP SAĞ YÖNDE VİDA AÇMA
EXTERNAL RIGHT HAND THREADING OPERATION
HERSTELLUNG VON AUßEN-RECHTSGEWINDE

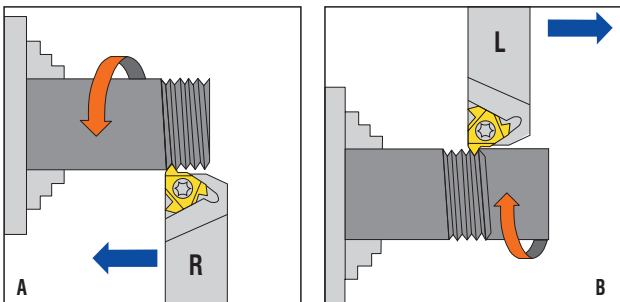

DIŞ ÇAP SOL YÖNDE VİDA AÇMA
EXTERNAL LEFT HAND THREADING OPERATION
HERSTELLUNG VON AUßEN-LINKSGEWINDE

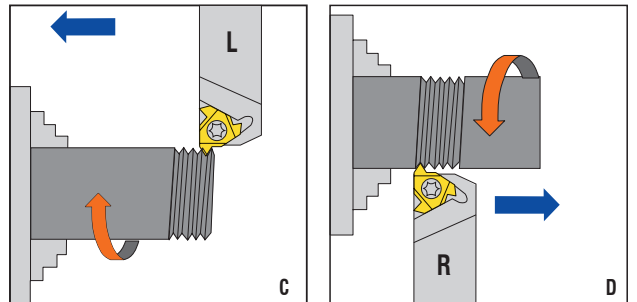

UYARI / WARNING / ACHTUNG

Figür B ve D için; negatif açılı altlık kullanılmalıdır. / For figure B and D; negative shim must be used. / Für Abbildung B und D; negative Unterlage verwenden.

Altiksız katerlerde B ve D figürü uygulanamaz. / B and D figures can not be applied on tools without shim. / Für Abbildung B und D; kann nicht mit Werkzeugen ohne Unterlegplatte erfolgen.

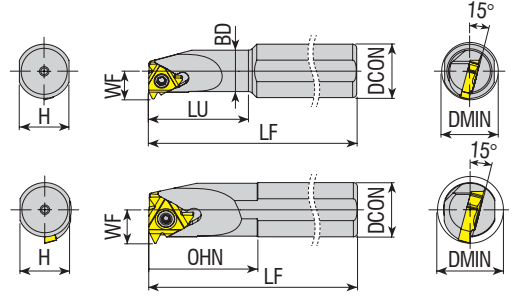
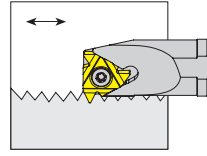

Takım Kodu Ordering Code Bestell-Bezeichnung	Stok Stock Lager		Takım Ölçüleri (mm) Dimension (mm) Abmessung (mm)						Kesici Uç Insert Wendeschneidplatte	Yedek Parçaları / Spare Parts / Ersatzteile												
	R	L	DCON	BD	LF	LU=OHN	WF	DMIN		Sıkma Vidası Screw Klemmschraube	Altlık Shim Unterlage	Altlık Vidası Shim Screw Schraube für Unterlage	Baskı Parçası Wedge Clamp Spannpratze	Baskı Vidası Clamp Screw Klemmschraube	Tork Anahtar Torx Key Torx Innenschlüssel							
SIR/L S12X05H 06	●	○	12	05	100	15	4.3	6.4	06 IR/L	3006-M2X3.6	-	-	-	-	82-T06							
SIR/L S16X05H 06	○	●	16	05	100	15	4.3	6.4														
SIR/L S16X07M 08	●	●	16	07	150	18	5.3	7.8	08 IR/L	3007-M2.2x4.6	-	-	-	-	82-T07							
SIR/L S10H 11	●	●	10	10	100	-	7.4	12	11 IR/L	4008-M2.5x6	-	-	-	-	82-T08							
new SIR/L A10H 11	●	○	10	10	100	-	7.4	12														
SIR/L S12K 11	●	●	12	12	125	-	8.4	15														
new SIR/L A12K 11	●	○	12	12	125	-	8.4	15														
SIR/L S16X10M 11	●	●	16	10	150	25	7.4	12														
SIR/L S16X13M 11	●	●	16	13	150	32	8.9	15														
SIR/L S16M 11	●	●	16	16	150	-	11.7	19														
SIR/L A16X13M 16	●	●	16	12.8	150	32	10.2	16								16 IR/L (0.35 - 3) ISO METRIC	4015-M3.5x9	-	-	-	-	80-T15
SIR/L S16X13M 16	●	●	16	13	150	32	10.2	16														
SIR/L S16M 16	●	●	16	16	150	-	11.7	19														
SIR/L S20X16P 16	●	●	20	16	170	40	11.7	19														
SIR/L A20X16P 16	●	●	20	16	170	40	11.7	19														
SIR/L S20P 16	●	●	20	20	170	-	13.7	24														
SIR/L S25R 16C	●	●	25	25	200	-	16.2	29														
SIR/L S32S 16C	●	●	32	32	250	-	19.7	36														
SIR/L S40T 16C	●	●	40	40	300	-	23.7	44														
SIR/L S50U 16C	●	●	50	50	350	-	28.7	54														
SIR/L S20P 22	●	●	20	20	170	-	15.7	24	22 IR/L (3.5 - 4.5) ISO METRIC	1020-M4.5x16	-	-	ACK-05	4015-M4x11	80-T20							
SIR/L S25R 22C	●	●	25	25	200	-	18.1	30														
SIR/L S32S 22C	●	●	32	32	250	-	21.6	38														
SIR/L S40T 22C	●	●	40	40	300	-	25.6	46														
SIR/L S50U 22C	●	●	50	50	350	-	30.6	58														
SIR/L S25R 16C-T	●	●	25	25	200	-	16.2	29	16 IR/L (1.5-3 TR)	4015-M3.5x14	-	-	ACK-05	-	80-T15							
SIR/L S32S 16C-T	●	●	32	32	250	-	19.7	36	22 IR/L (4-6 TR)	4015-M4x11	-	-	-	-	80-T20							
SIR/L S25R 22C-T	●	●	25	25	200	-	18.1	30														
SIR/L S32S 22C-T	●	●	32	32	250	-	21.6	38														

R: Sağ / Right / Rechts L: Sol / Left / Links ● Stokta / In Stock / Auf Lager ○ Stokta Yok / Non Stock Item / Нет в наличии
Takımlar standart 1.5° helis açılı olarak üretilir. / The tools have a built in 1.5° helix angle. / GEWINDE-DREHHALTER werden mit Einstellwinkel 1.5° hergestellt
UYARI / WARNING / ACHTUNG Sayfa 114'deki B ve D figürleri uygulanamaz. / The operation for B and D on page 114 can not be applied. / 114: für Abbildung B und D: nicht verwenden

Sipariş Örneği/Ordering Example/Bestellbeispiel
1 ad./pcs./stück SIR S12X05H 06

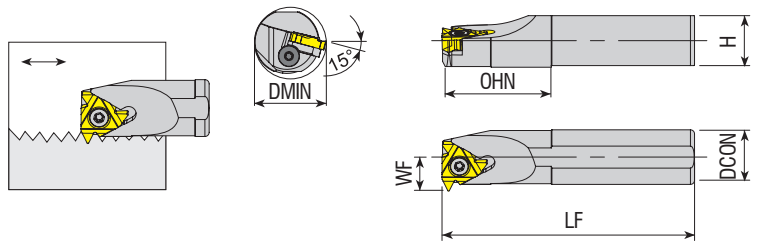

Takım Kodu Ordering Code Bestell-Bezeichnung	Stok Stock Lager		Takım Ölçüleri (mm) Dimension (mm) Abmessung (mm)						Kesici Uç Insert Wendeschneidplatte	Yedek Parçaları / Spare Parts / Ersatzteile						
	R	L	DCON	H	LF	OHN	WF	DMIN		Sıkma Vidası Screw Klemmschraube	Sol Altlık Left Shim U-Platte für WSP links	Sağ Altlık Right Shim U-Platte für WSP rechts	Altlık Vidası Shim Screw Schraube für Unterlage	Altlık Vidası Pulu Shim Screw Ring Schraube für Unterlagering	Tork Anahtar Torx Key Torx Innensechskantschlüssel	
TIR/L S25R 16	●	●	25	23	200	-	16.2	29	16 IR/L	1710-U5-40x12.2	ATS-16E	ATS-16I	AAV-11-U5-40x4.5	ABPL-03	82-T10	
TIR/L S32S 16	●	●	32	30	250	-	19.7	36								
TIR/L S40T 16	●	●	40	37.5	300	-	23.7	44								
TIR/L S50U 16	●	●	50	47	350	-	28.7	54								
TIR/L S25R 22	●	●	25	23	200	-	18.1	29	22 IR/L	1720-U8-32x15	ATS-22E	ATS-22I	AAV-12-U8-32x5.5	ABPL-04	80-T20	
TIR/L S32S 22	●	●	32	30	250	-	21.6	38								
TIR/L S40T 22	●	●	40	37.5	300	-	25.6	46								
TIR/L S50U 22	●	●	50	47	350	-	30.6	58								
TIR/L S32S 27	●	●	32	30	250	-	22.6	40	27 IR/L	1620-M5x18	ATS-27E	ATS-27I	AAV-15-M5x5.7	ABPL-05	80-T20	
TIR/L S40T 27	●	●	40	37.5	300	-	26.6	48		1620-M5x22						
TIR/L S50U 27	●	●	50	47	350	-	31.6	58								
TIR/L A20P 16	●	○	20	18	170	40	13.7	24	16 IR/L	1710-U5-40x12.2	ATS-16E	ATS-16I	AAV-11-U5-40x4.5	ABPL-03	82-T10	
TIR/L A25R 16	○	●	25	23	200	50	16.2	29								
TIR/L A32S 16	○	●	32	30	250	60	19.7	36								
TIR/L A40T 16	○	●	40	37.5	300	65	23.9	44								

R: Sağ / Right / Rechts L: Sol / Left / Links ● Stokta / In Stock / Auf Lager ○ Stokta Yok / Non Stock Item / Kein Lagerartikel, Lieferzeit auf Anfrage
Takımlar standart 1.5° helis açılı olarak üretilir. / The tools have a built in 1.5° helix angle. / GEWINDE-DREHHALTER werden mit Einstellwinkel 1.5° hergestellt

Sipariş Örneği/Ordering Example/Bestellbeispiel
1 ad./pcs./stück TIR S25R 16

DELİK İÇİ SAĞ YÖNDE VİDA AÇMA
INTERNAL RIGHT HAND THREADING OPERATION
HERSTELLUNG VON INNEN-RECHTSGEWINDE

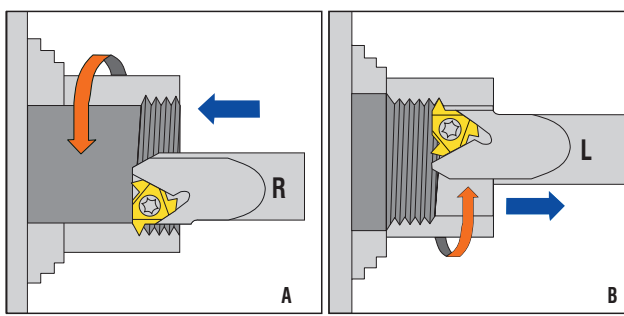

DELİK İÇİ SOL YÖNDE VİDA AÇMA
INTERNAL LEFT HAND THREADING OPERATION
HERSTELLUNG VON INNEN-LINKSGEWINDE

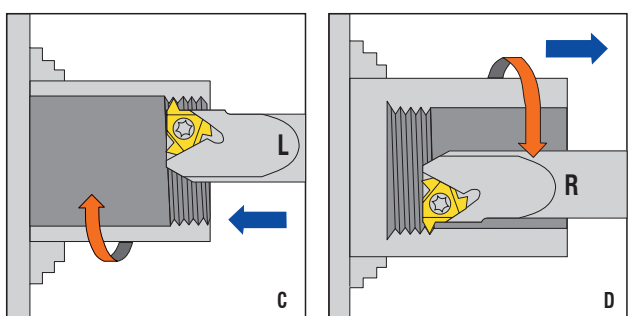

UYARI / WARNING / ACHTUNG

Figür B ve D için; negatif açılı altlık kullanılmalıdır. / For figure B and D; negative shim must be used. / Für Abbildung B und D; negative Unterlage verwenden.
Altlıksız katerlerde B ve D figürü uygulanamaz. / B and D figures can not be applied on tools without shim. / Für Abbildung B und D; kann nicht mit Werkzeugen ohne Unterlegplatte erfolgen.

Diş Helis Açısı Thread Helix Angle Steigungswinkel

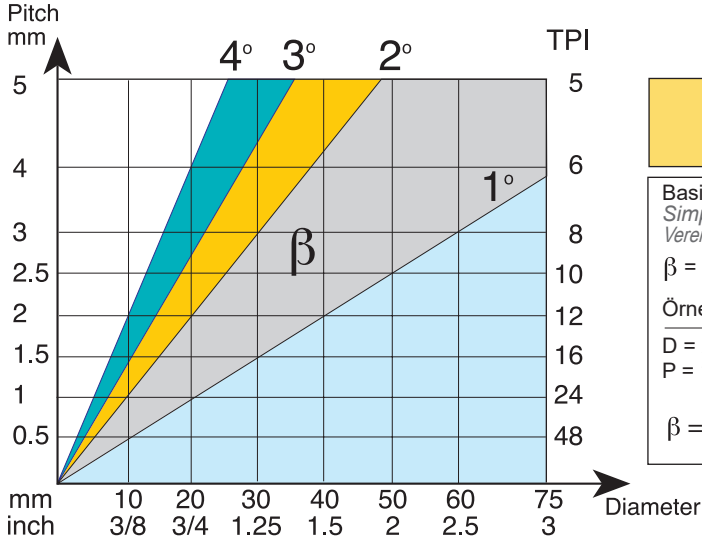

$$\tan \beta = \frac{P}{\pi \times D}$$

Basitleştirilmiş formül
 Simplified formula
 Vereinfachte Formel

$$\beta = 20 P/D$$

Örnek / Example / Beispiel :

$$D = 25 \text{ mm (0.98")}$$

$$P = 1.5 \text{ mm (16 TPI)}$$

$$\beta = \frac{20 \times 1.5}{25} = 1.2^\circ$$

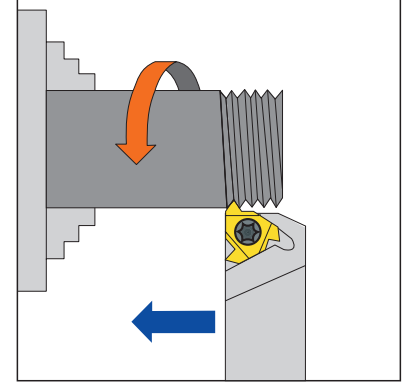

Standart ve Eğik Altlıklar Standard and Slanted Shim Standard und Schräge Unterlegplatte

Akko diş açma takımlarının, uç yuvaları 1.5° helis açılı olarak üretilir. Farklı helis açılı diş açmak isteyenler altlığı değiştirerek istedikleri dereceyi elde edebilirler. Negatif helis genellikle sol katerde sağ diş çekmek için kullanılır ya da sağ katerde sol diş çekmek için kullanılır.

Akko Toolholders Pockets have a built in 1.5° helix angle. This angle may be adjusted to better match the thread helix angle by simply changing the shim.

Negative helix is usually used when threading RH thread with LH Holder or LH thread with RH Holder.

Die Akko-Gewindedrehhalter werden mit 1,5°-Steigungswinkel produziert. Durch Wechseln der Unterlage kann dieser Winkel dem optimalen Steigungswinkel angepasst werden. Die Unterlagen mit negativem Winkel werden eingesetzt, wenn ein Rechtsgewinde mit einem linken Halter oder ein Linksgewinde mit einem rechten Halter gefertigt werden soll.

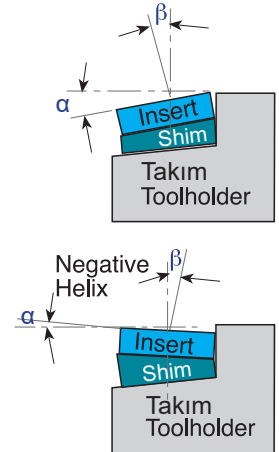

Uç Yuvasının Açısı (α) / Pocket's Angle (α) / Winkel Wendeplattensitz (α)

L	IC	Takım Tipi Tool Type Werkzeugtyp	Uç Yuvasının Açısı (α) / Pocket's Angle (α) / Winkel Wendeplattensitz (α)						
			4.5°	3.5°	2.5°	1.5°	0.5°	-0.5°	-1.5°
16	3/8	EX-RH or IN-LH	ATS-16E+4.5	ATS-16E+3.5	ATS-16E+2.5	ATS-16E	ATS-16E+0.5	ATS-16E-0.5	ATS-16E-1.5
16	3/8	EX-LH or IN-RH	ATS-16I+4.5	ATS-16I+3.5	ATS-16I+2.5	ATS-16I	ATS-16I+0.5	ATS-16I-0.5	ATS-16I-1.5
22	1/2	EX-RH or IN-LH	ATS-22E+4.5	ATS-22E+3.5	ATS-22E+2.5	ATS-22E	ATS-22E+0.5	ATS-22E-0.5	ATS-22E-1.5
22	1/2	EX-LH or IN-RH	ATS-22I+4.5	ATS-22I+3.5	ATS-22I+2.5	ATS-22I	ATS-22I+0.5	ATS-22I-0.5	ATS-22I-1.5
27	5/8	EX-RH or IN-LH	ATS-27E+4.5	ATS-27E+3.5	ATS-27E+2.5	ATS-27E	ATS-27E+0.5	ATS-27E-0.5	ATS-27E-1.5
27	5/8	EX-LH or IN-RH	ATS-27I+4.5	ATS-27I+3.5	ATS-27I+2.5	ATS-27I	ATS-27I+0.5	ATS-27I-0.5	ATS-27I-1.5

Altlık Değişirme Öneri Tablosu / Shim Change Recommendation Empfehlungen zum Wechseln der Unterlage

Tabloda da görüldüğü gibi bazı diş hatvelerinin çaplara göre kombinasyonları altlık değişimini gerektirir. Eğer değişim gerekli ise EX-RH ve IN-LH katerleri için ATS-E altlıklarını, IN-RH ve EX-LH katerleri için ATS-I altlıklarını kullanın.
 As can be seen from the chart, some Pitch to Diameter combinations require a shim change. If change is required, use ATS-E shim for EX-RH and IN-LH toolholders and ATS-I shims for IN-RH and EX-LH toolholders.

Wie aus der Tabelle ersichtlich, erfordern einige Steigung-Durchmesser-Kombinationen einen Wechsel der Unterlage. In diesem Fall wird eine ATS-E-Unterlage auf einem rechten Außenhalter bzw. einem linken Innenhalter eingesetzt. Die ATS-I-Unterlage kommt bei einem rechten Innenhalter bzw. einem linken Außenhalter zum Einsatz.

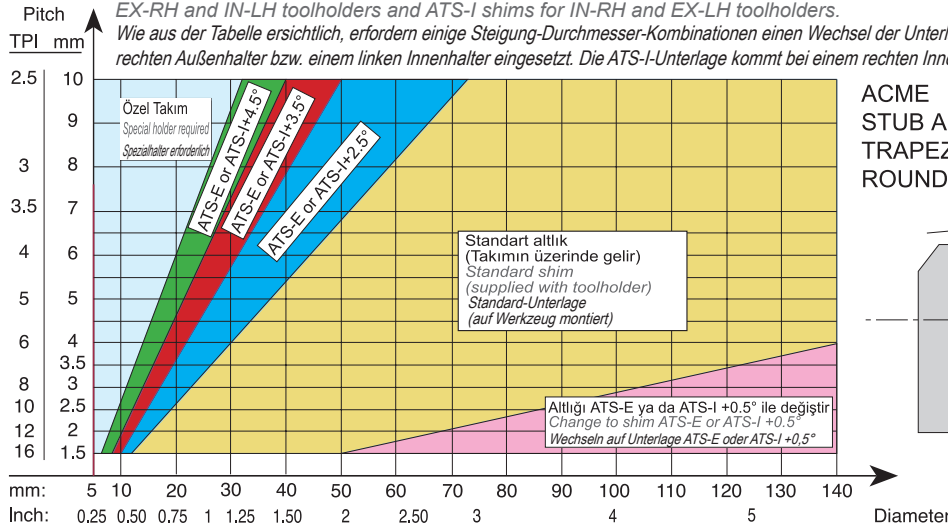

ACME
 STUB ACME
 TRAPEZ (DIN 103)
 ROUND (DIN 405)

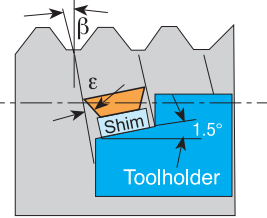

Tabloda da görüldüğü gibi çoğu uygulamalar altlık değişimine ihtiyaç duymaz. Eğer değişime ihtiyaç duyulursa EX-RH ve IN-LH katerleri için ATS-E altlıklarını, IN-RH ve EX-RH katerleri için ATS-I altlıklarını kullanın.

As can be seen from the chart, most applications do not require a shim change. If change is required, use ATS-E shims for EX-RH and IN-LH toolholders and ATS-I shims for IN-RH and EX-LH toolholders.

Wie aus der Tabelle ersichtlich, erfordern einige Steigung-Durchmesser-Kombinationen einen Wechsel der Unterlage. In diesem Fall wird eine ATS-E-Unterlage auf einem rechten Außenhalter bzw. einem linken Innenhalter eingesetzt. Die ATS-I-Unterlage kommt bei einem rechten Innenhalter bzw. einem linken Außenhalter zum Einsatz.

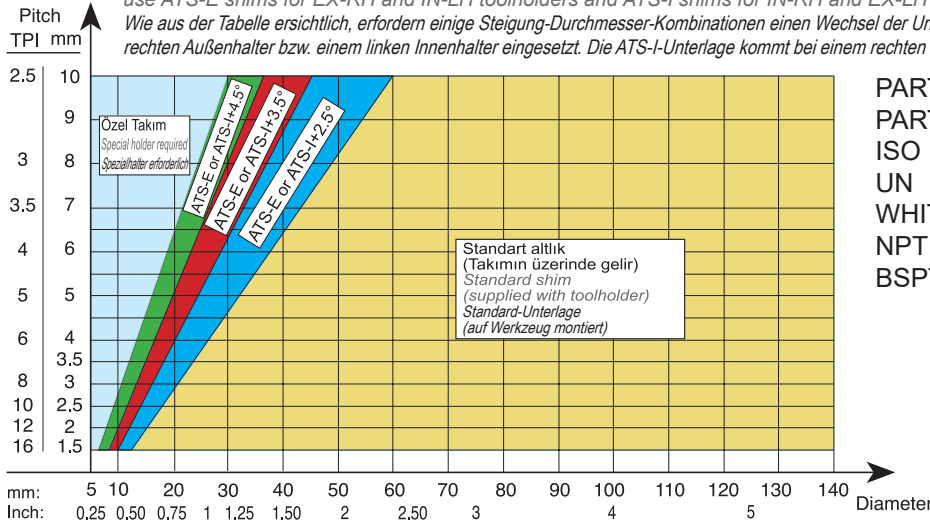

PARTIAL PROFILES 60°
 PARTIAL PROFILES 55°
 ISO
 UN
 WHIT.
 NPT
 BSPT

Tabloda da görüldüğü gibi çoğu uygulamalar altlık değişimine ihtiyaç duyar. Çoğu durumda negatif bir altlığa ihtiyaç duyulur. EX-RH ve IN-LH takımlar için ATS-E altlıklarını kullanın. IN-RH ve EX-LH takımlar için ATS-I altlıklarını kullanın.

As can be seen from the chart, most applications require a shim change. In most cases a negative shim is required, use ATS-E shims for EX-RH and IN-LH toolholders. ATS-I shims for IN-RH and EX-LH toolholders.

Wie aus der Tabelle ersichtlich, erfordern einige Steigung-Durchmesser-Kombinationen einen Wechsel der Unterlage. In diesem Fall wird eine ATS-E-Unterlage auf einem rechten Außenhalter bzw. einem linken Innenhalter eingesetzt. Die ATS-I-Unterlage kommt bei einem rechten Innenhalter bzw. einem linken Außenhalter zum Einsatz.

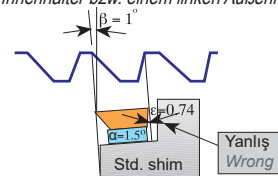
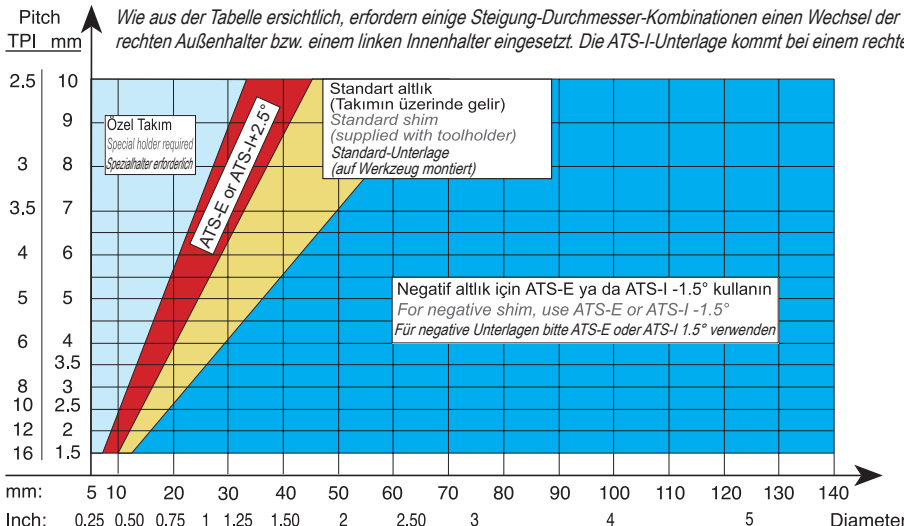

Before Shim Change
 Altlığı Değişirmeden Önce
 До смены опорной пластины

AMERICAN
 BUTTRESS
 SAGENGEWINDE
 (DIN 513)

Standart altlığın negatif bir altlıkla değiştirilmesi, kenar sürtmesini engelleyecektir.

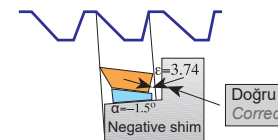

After Shim Change
 Altlığı Değişirdikten Sonra
 Nach dem Wechsel der Unterlegplatte

Replacing the standard shim with a shim has negative angle, will eliminate side rubbing
 Das Ersetzen der Standard-Unterlegplatte durch eine Unterlegplatte mit negativem Winkel verhindert seitliche Reibung.



konusulan
the spoken kalite...
quality...

KANAL AÇMA

KANAL AÇMA TAKIMLARI
GROOVING TOOLHOLDERS
STECHHALTER





AKKO **A** **AKT** - **K** - **R** - **2525**

100 - **150** - **4** - **T22**

2 Kesici Stili / Cutter Style / Cutter-Stil

DKT: Dış Çap Kanal Açma Takımı / External Grooving Toolholders
Außen-Steckhalter
IKT: Delik İçi Kanal Açma Takımı / Internal Grooving Toolholders
Innen-Steckhalter
AKT: Dış Çap Alın Kanal Takımları / Face Grooving Toolholders
Axial-Steckhalter
LKT: L Tip Alın Kanal Açma Takımı / L Type Face Grooving Toolholders
Axial-Steckhalter L-Type

3 Uç Tipi / Insert Type / Plattenform

KRLY / MGM.
HRN / S312, S229, S224, S223
ISCR / DGN, GI, GTN
SNDVK / 123, 151, 154.91
ZCC
KM / A4.
ARN / LOMR.

TGTC / TD.

4 Kesme Yönü / Cutting Direction Halteausführung

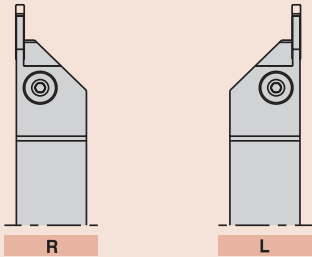

Lütfen AAKT ürünleri için kesme yönünün gösterilen tersi olduğunu unutmayın.
Please be informed that for AAKT products cutting direction is vice versa what is shown.
Bitte beachten Sie, dass die Schnitttrichtung für AAKT-Produkte umgekehrt zur Darstellung ist.

5 Kesme Kenar Yüksekliği ve Şaft Genişliği Cutting Edge Height and Shank Width Schafthöhe und Schaftbreite

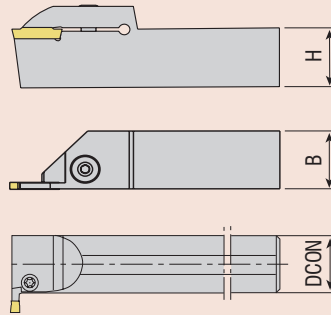

6 Kesme Aralığı Cutting Diameter Durchmesser für Axialeinstechen

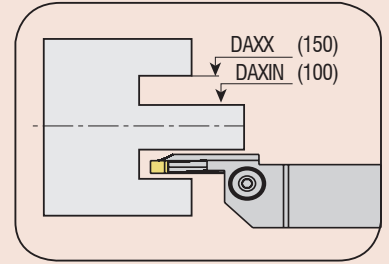

7 Kesme Kenar Genişliği / Cutting Width Edge Plattenbreite

ÖR/E.G. :
2 = 2.0 mm
3 = 3.0 mm
4 = 4.0 mm
5 = 5.0 mm
6 = 6.0 mm
8 = 8.0 mm

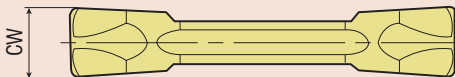

8 Kesme Derinliği / Cutting Depth / Maximale Schnitttiefe

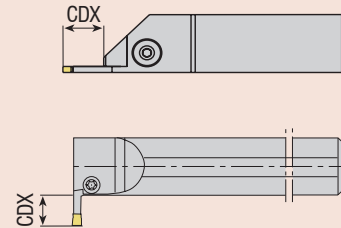

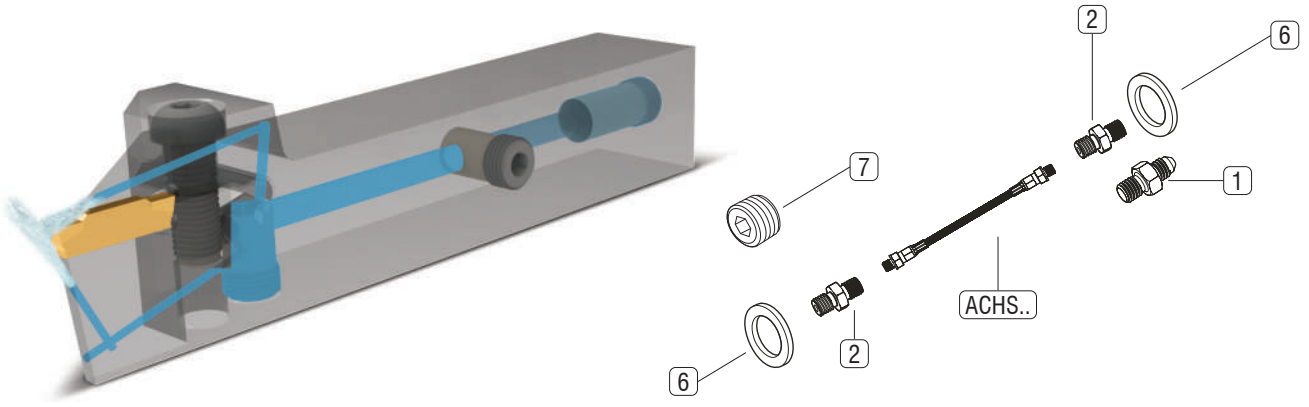

Not: İçten soğutmalı tüm torna katerlerinde kullanılacak 3 tip soğutma hortum setleri tasarlanmıştır. Takımların kullanılmasından önce, kullanılmayan bağlantıların set içindeki vida ile kapatılarak sızdırmazlığın sağlanmasına dikkat edilmelidir. Torna katerlerine yönelik soğutma hortum setleri, ACHS... 10 bar ile maksimum 150 bar basınç aralığında kullanılabilir.

Note: 3 types of cooling hose sets are designed that can be used in all internally cooled lathes. Before using the tools, care should be taken to ensure that the unused connections are closed with the screw in the set and that sealing is ensured. Cooling hose sets for lathe tools can be used in the pressure range of ACHS ... 10 bar to max 150 bar.

Note: Es wurden 3 Arten von Kühlschlauch-Sets entwickelt, die in allen intern gekühlten Drehmaschinen verwendet werden können. Vor der Verwendung der Werkzeuge sollte darauf geachtet werden, dass die nicht verwendeten Verbindungen mit der Schraube im Satz geschlossen werden und die Abdichtung gewährleistet ist. Kühlschlauchsätze für Drehmaschinen können im Druckbereich von ACHS ... 10 bar bis max. 150 bar eingesetzt werden.

Set içindeki Parçalar Parts In The Set Teile im Set				Uzunluk / Length Code / Länge Einstellen: 250		
				Set Kodu: Set Code: Code Einstellen: ACHS-1-250	Set Kodu: Set Code: Code Einstellen: ACHS-2-250	Set Kodu: Set Code: Code Einstellen: ACHS-3-250
	Resim Picture Bild	Takım Kodu Set Code Code Einstellen	Ürün Açıklaması Product Description Artikelbeschreibung			
1		AMP-01	M10 Bağlantı Elemanı M10 Fastener M10 Verschluss	1x	-	-
2		AMP-02	G 1/8" Çift Bağlantı Elemanı G 1/8" Double Fastener G 1/8" Doppelverschluss	2x	1x	-
3		AMP-03	G 1/8" Açılı Bağlantısı G 1/8" Angle Connection G 1/8" Winkelverbindung	-	1x	2x
4		AMP-04	M10" Açılı Bağlantısı M10" Angle Connection M10" Winkelverbindung	-	1x	1x
5		AMP-05	G1/4"-G1/8" Kısalma Parçası G1/4"-G1/8" Capillary Piece G1/4"-G1/8" Kapillarstück	-	1x	1x
6		AG-01	Bakır Conta Copper Gasket Kupferdichtung	2x	3x	4x
7		2705-G1/8-5.5	G1/8" Sızdırmaz Civata G1/8" Sealing Bolt G1/8" Dichtungsschraube	1x	1x	1x
8		AH-1-250	Hortum Hose Schlauch	1x	-	-
9		AH-2-250	Hortum Hose Schlauch	-	1x	-
10		AH-3-250	Hortum Hose Schlauch	-	-	1x

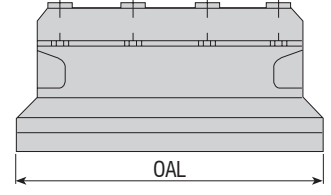
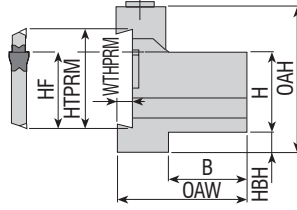

Takım Kodu Ordering Code Bestell-Bezeichnung	Stok Stock Lager	Takım Ölçüleri (mm) Dimension (mm) Abmessung (mm)									Yedek Parçaları / Spare Parts / Ersatzteile		
		HTPRM	HF	H	HBH	OAH	WTHPRM	OAL	B	OAW	Pabuç Clamp Spannspratze	Pabuç Vidası Clamp Screw Klemmschraube	Anahtar Allen Key Innensechskantschlüssel
ALBU-20-26	●	26	21.4	20	9	43	4	86	19	38	ABK-01	2505-M6x25	AAL-07-5
ALBU-25-26	●	26	21.4	25	5	45	4	110	23	42	ABK-02	2505-M6x30	
ALBU-20-32	●	32	25	20	13	50	5.3	100	19	38	ABK-03		
ALBU-25-32	●	32	25	25	8	50	5.3	110	23	42	ABK-04		
ALBU-32-32	●	32	25	32	5	54	5.3	110	29	48			

İÇTEN SU VERME KANALLI KESME VE DERİN KANAL AÇMA LAMA BLOĞU
BLOCK FOR PARTING&GROOVING TOOLS WITH INTERNAL COOLANT HOLE
BLOCK FÜR TEILUNG&AUSHOLUNG MIT INNEN KÜHLUNG

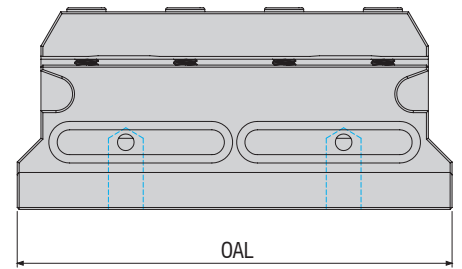
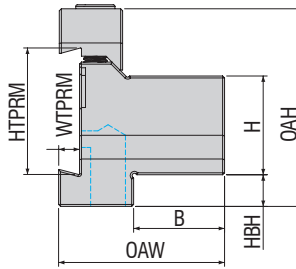

Takım Kodu Ordering Code Bestell-Bezeichnung	Stok Stock Lager	Takım Ölçüleri (mm) Dimension (mm) Abmessung (mm)									Yedek Parçaları / Spare Parts / Ersatzteile				
		HTPRM	HD	H	HBH	AOH	WTHPRM	OAL	B	OAW	Pabuç Clamp Spannspratze	Oring Ring Feder	Sızdırmaz Vida Threaded Pin Gewindestift	Pabuç Vidası Clamp Screw Klemmschraube	Anahtar Allen Key Innensechskantschlüssel
ALBU-20-32-H	●	32	20	20	13	36.50	5.30	100	19	38	ABK-03	AOR-43	2705-G1/8x5.5	2505-M6x30	AAL-07-5
ALBU-25-32-H	●	32	25	25	8	50	5.30	110	23	42	ABK-04	AOR-46			
ALBU-32-32-H	●	32	32	32	5	40.50	5.30	110	29	48	ABK-04				

R: Sağ / Right / Rechts L: Sol / Left / Links



● Stokta / In Stock / Auf Lager ○ Stokta Yok / Non Stock Item / Kein Lagerartikel, Lieferzeit auf Anfrage

Sipariş Örneği/Ordering Example/Bestellbeispiel

1 ad./pcs./stück ALBU-20-26

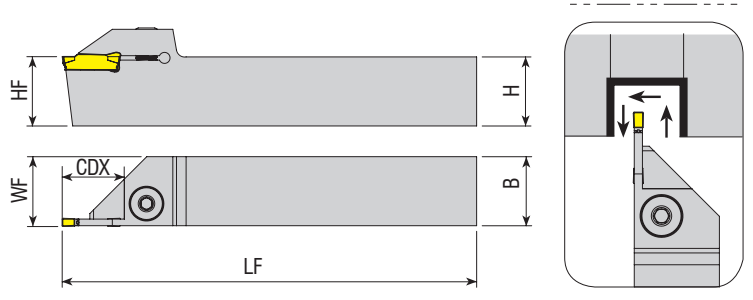
AKKO Ucuna Uygundur. / Compatible with AKKO Insert. / Kompatibel mit AKKO Wendeplatten.



Takım Kodu Ordering Code Bestell-Bezeichnung	Stok Stock Lager		Takım Ölçüleri (mm) Dimension (mm) Abmessung (mm)				Kesici Uç Insert Wendeschneidplatte	Yedek Parçaları / Spare Parts / Ersatzteile			
	R	L	HF=H	B	LF	WF		CDX	Sıkma Vidası Screw Klemmschraube	Pul Stamp Ring	Anahtar Allen Key Innensechskantschlüssel
ADKT-K-R/L-1212-1.5-T15	●	●	12	12	100	12.2	15	AGD. -1.5			
ADKT-K-R/L-2020-1.5-T15	●	●	20	20	125	20.2	15				
ADKT-K-R/L-1212-2-T15	●	●	12	12	100	16.3	15				
ADKT-K-R/L-1616-2-T10	●	●	16	16	125	16.3	10	AGD. -2	AKV-02-M6x22	ABPL-01	AAL-03-3
ADKT-K-R/L-1616-2-T15	●	●	16	16	125	16.3	15				
ADKT-K-R/L-2020-2-T15	●	●	20	20	150	20.3	15				
ADKT-K-R/L-2525-2-T15	●	●	25	25	150	25.3	15				
ADKT-K-R/L-3232-2-T15	●	●	32	32	170	32.3	15				
ADKT-K-R/L-1212-3-T15	●	●	12	12	100	12.3	15				
new ADKT-K-R/L-1616-3-T7	●	●	16	16	125	16.3	7	AGD. -3			
ADKT-K-R/L-1616-3-T15	●	●	16	16	125	16.3	15				
ADKT-K-R/L-2020-3-T10	●	●	20	20	125	20.3	10				
ADKT-K-R/L-2020-3-T20	●	●	20	20	125	20.3	20				
ADKT-K-R/L-2020-3-R28	●	●	20	20	125	20.3	28				
ADKT-K-R/L-2525-3-T10	●	●	25	25	150	25.3	10				
ADKT-K-R/L-2525-3-R15	●	●	25	25	150	25.3	15				
ADKT-K-R/L-2525-3-T22	●	●	25	25	150	25.3	22				
new ADKT-K-R/L-2525-3-T30	●	●	25	25	150	25.3	30				
ADKT-K-R/L-3232-3-T10	●	●	32	32	170	32.3	10				
ADKT-K-R/L-3232-3-T22	●	●	32	32	170	32.3	22				
ADKT-K-R/L-2020-4-T10	●	●	20	20	125	20.4	10				
ADKT-K-R/L-2020-4-T20	●	●	20	20	125	20.4	20				
ADKT-K-R/L-2020-4-R25	●	○	20	20	125	20.4	25				
ADKT-K-R/L-2525-4-T10	●	●	25	25	150	25.4	10				
ADKT-K-R/L-2525-4-T18	●	●	25	25	150	25.4	18				
ADKT-K-R/L-2525-4-T22	●	●	25	25	150	25.4	22				
ADKT-K-R/L-3232-4-T10	●	●	32	32	170	32.4	10				
ADKT-K-R/L-3232-4-T22	●	●	32	32	170	32.4	22				
ADKT-K-R/L-2020-5-T20	●	●	20	20	125	20.5	20	AGD. -5			
ADKT-K-R/L-2525-5-T15	●	●	25	25	150	25.5	15				
ADKT-K-R/L-2525-5-T18	●	●	25	25	150	25.5	18				
ADKT-K-R/L-2525-5-T25	●	●	25	25	150	25.5	25				
ADKT-K-R/L-3232-5-T15	●	●	32	32	170	32.5	15				
ADKT-K-R/L-3232-5-T25	●	●	32	32	170	32.5	25				
ADKT-K-R/L-2525-6-T15	●	●	25	25	150	25.6	15	AGD. -6			
ADKT-K-R/L-2525-6-T25	●	●	25	25	150	25.6	25				
ADKT-K-R/L-3232-6-T25	●	●	32	32	170	32.6	25				
ADKT-K-R/L-3232-8-T32	●	●	32	32	170	32.8	32				

R: Sağ / Right / Rechts L: Sol / Left / Links

● Stokta / In Stock / Auf Lager ○ Stokta Yok / Non Stock Item / Kein Lagerartikel, Lieferzeit auf Anfrage

AKKO Ucuna Uygundur. / Compatible with AKKO Insert. / Kompatibel mit AKKO Wendeplatten.

Sipariş Örneği/Ordering Example/Bestellbeispiel

1 ad./pcs./stück ADKT-K-R-1212-1.5-T15

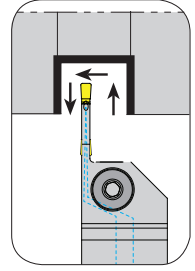
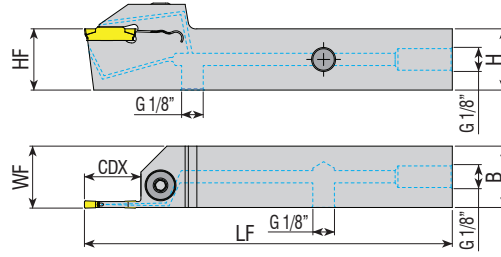

Takım Kodu Ordering Code Bestell-Bezeichnung	Stok Stock Lager		Takım Ölçüleri (mm) Dimension (mm) Abmessung (mm)				Kesici Uç Insert Wendeschneidplatte	Yedek Parçaları / Spare Parts / Ersatzteile			
	R	L	HF=H	B	LF	WF		CDX	Sıkma Vidası Screw Klemmschraube	Pul Stamp Ring	Anahtar Allen Key Innensechskantschlüssel
ADKT-K-R/L-1616-2-T10-H	●	○	16	16	125	16.2	10	AGD.-2	AKV-02-M6x22	ABPL-01	AAL-03-3
ADKT-K-R/L-1616-3-T15-H	●	○	16	16	125	16.3	15	AGD.-3	2004-M8x1x20	-	AAL-05-4
ADKT-K-R/L-2020-3-R22-H	○	●	20	20	125	20.3	22				
ADKT-K-R/L-2020-3-T20-H	●	●	20	20	125	20.4	20	AGD.-4	2004-M8x1x20	-	AAL-05-4
ADKT-K-R/L-2525-3-T22-H	●	●	25	25	150	25.4	22				
ADKT-K-R/L-2020-4-T20-H	●	●	20	20	125	20.4	20	AGD.-5	2004-M8x1x20	-	AAL-05-4
ADKT-K-R/L-2525-4-T22-H	●	●	25	25	150	25.4	22				
ADKT-K-R/L-2525-5-T25-H	●	●	25	25	150	25.5	25				

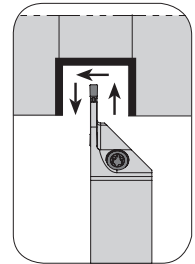
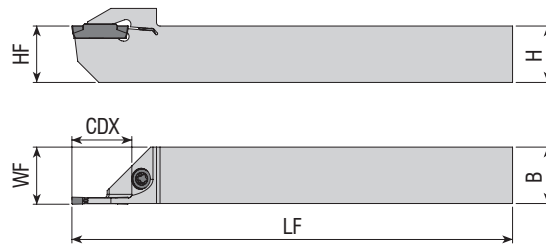

Takım Kodu Ordering Code Bestell-Bezeichnung	Stok Stock Lager		Takım Ölçüleri (mm) Dimension (mm) Abmessung (mm)				Kesici Uç Insert Wendeschneidplatte	Yedek Parçaları / Spare Parts / Ersatzteile			
	R	L	HF=H	B	LF	WF		CDX	Sıkma Vidası Screw Klemmschraube	Pul Stamp Ring	Tork Anahtar Torx Key Torx Innensechskantschlüssel
ADKT-K-R/L-1212-2-R12-K-S	●	●	12	12	125	12.20	12	AGD.-2	4015-M4x11	-	80-T15
ADKT-K-R/L-1616-2-R16-K-S	●	●	16	16	125	16.20	16				
ADKT-K-R/L-1212-3-R12-K-S	●	●	12	12	125	12.30	12	AGD.-3	4015-M4x11	-	80-T15
ADKT-K-R/L-1616-3-R16-K-S	●	●	16	16	125	16.30	16				

R: Sağ / Right / Rechts L: Sol / Left / Links

● Stokta / In Stock / Auf Lager ○ Stokta Yok / Non Stock Item / Kein Lagerartikel, Lieferzeit auf Anfrage

AKKO Ucuna Uygundur. / Compatible with AKKO Insert. / Kompatibel mit AKKO Wendeplatten.

Sipariş Örneği/Ordering Example/Bestellbeispiel

1 ad./pcs./stück ADKT-K-R-1616-2-T10-H

AKKO Ucuna Uygundur. / Compatible with AKKO Insert. / Kompatibel mit AKKO Wendeplatten.

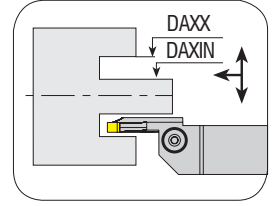
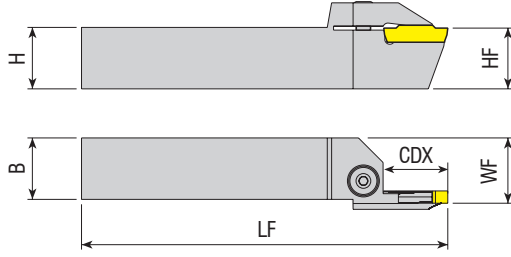

Takım Kodu
Ordering Code
Bestell-Bezeichnung

Takım Kodu Ordering Code Bestell-Bezeichnung	Stok Stock Lager		Takım Ölçüleri (mm) Dimension (mm) Abmessung (mm)							Kesici Uç Insert Wendeschneidplatte	Yedek Parçaları / Spare Parts / Ersatzteile		
	R	L	HF=H	B	LF	WF	CDX	DAXIN	DAXX	Sıkma Vidası Screw Klemmschraube	Pul Stamp Ring	Tork Anahtar Torx Key Torx /Innensechskantschlüssel	
AAKT-K-R/L-2525-34-45-3-T17	●	●	25	25	150	26.5	17	34	45	AGD. -3			
AAKT-K-R/L-2525-39-55-3-T17	●	●	25	25	150	26.5	17	39	55				
AAKT-K-R/L-2525-49-80-3-T17	●	●	25	25	150	26.5	17	49	80				
AAKT-K-R/L-2525-70-110-3-T17	●	●	25	25	150	26.5	17	70	110				
AAKT-K-R/L-2525-100-150-3-T17	●	●	25	25	150	26.5	17	100	150				
AAKT-K-R/L-2525-80-180-3-T32	●	●	25	25	150	26.5	32	80	180				
AAKT-K-R/L-2525-175-215-3-T22	●	●	25	25	150	26.5	22	175	215				
AAKT-K-R/L-2525-700-800-3-T17	●	●	25	25	150	26.5	17	700	800	AGD. -4	2004-M8x1x20	-	AAL-05-4
AAKT-K-R/L-3232-140-450-3-T17	●	●	32	32	170	33.5	17	140	450				
AAKT-K-R/L-2525-50-85-4-T22	●	●	25	25	150	26.5	22	50	85				
AAKT-K-R/L-2525-70-110-4-T22	●	●	25	25	150	26.5	22	70	110				
AAKT-K-R/L-2525-100-150-4-T22	●	●	25	25	150	26.5	22	100	150				
AAKT-K-R/L-2525-80-180-4-T32	●	●	25	25	150	26.5	32	80	180				
AAKT-K-R/L-2525-180-800-4-T32	●	●	25	25	150	26.5	32	180	800				
AAKT-K-R/L-2525-70-110-5-T25	●	●	25	25	150	26.5	25	70	110	AGD. -5			
AAKT-K-R/L-2525-100-150-5-T25	●	●	25	25	150	26.5	25	100	150				
AAKT-K-R/L-2525-100-200-5-T45	●	●	25	25	150	26.5	45	100	200				
AAKT-K-R/L-2525-80-180-5-T32	●	●	25	25	150	26.5	32	80	180				
AAKT-K-R/L-2525-140-200-5-T25	●	○	25	25	150	26.5	25	140	200				
AAKT-K-R/L-2525-180-800-5-T32	●	●	25	25	150	26.5	32	180	800				
AAKT-K-R/L-2525-180-800-5-T40	●	○	25	25	150	26.5	40	180	800				
AAKT-K-R/L-2525-60-100-6-T25	●	○	25	25	150	26.5	25	60	100	AGD. -6			
AAKT-K-R/L-2525-60-100-6-T35	●	○	25	25	150	26.5	35	60	100				
AAKT-K-R/L-2525-100-200-6-T25	●	○	25	25	150	26.5	25	100	200				
AAKT-K-R/L-2525-100-200-6-T35	●	●	25	25	150	26.5	35	100	200				
AAKT-K-R/L-2525-100-200-6-T45	●	○	25	25	150	26.5	45	100	200				
AAKT-K-R/L-2525-140-300-6-T35	●	●	25	25	150	26.5	35	140	300				
AAKT-K-R/L-2525-180-360-6-T40	●	○	25	25	150	26.5	40	180	360				
AAKT-K-R/L-3232-140-800-6-T25	○	○	32	32	170	33.5	25	140	800	AGD. -8			
AAKT-K-R/L-3232-180-800-6-T41	○	○	32	32	170	33.5	41	180	800				
AAKT-K-R/L-3232-400-500-6-T25	●	○	32	32	170	33.5	25	400	500				
AAKT-K-R/L-2525-140-300-8-T35	●	○	25	25	150	26.5	35	140	300	AGD. -8			
AAKT-K-R/L-3232-140-350-8-T35	●	○	32	32	150	33.5	35	140	350				

R: Sağ / Right / Rechts L: Sol / Left / Links

● Stokta / In Stock / Auf Lager ○ Stokta Yok / Non Stock Item / Kein Lagerartikel, Lieferzeit auf Anfrage

AKKO Ucuna Uygundur. / Compatible with AKKO Insert. / Kompatibel mit AKKO Wendeplatten.

Sipariş Örneği/Ordering Example/Bestellbeispiel

1 ad./pcs./stück AAKT-K-R-2525-34-45-3-T17

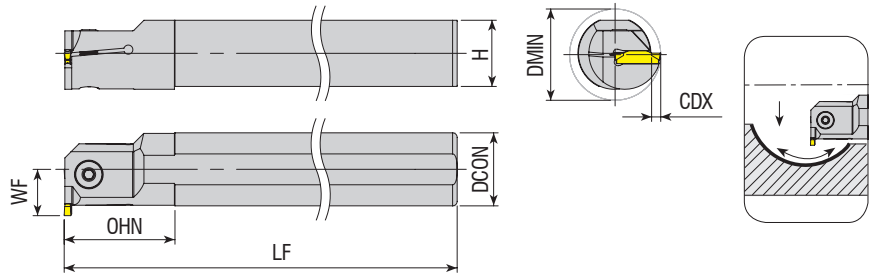

Takım Kodu
Ordering Code
Bestell-Bezeichnung

Stok
Stock
Lager

Takım Ölçüleri (mm)
Dimension (mm)
Abmessung (mm)

Kesici Uç
Insert
Wendeschneidplatte

Yedek Parçaları / Spare Parts / Ersatzteile

Sıkma Vidası
Screw
Klemmschraube

Anahtar
Allen Key
Innensechskantschlüssel

	R	L	DCON	DMIN	LF	OHN	CDX	H	WF			
AIKT-K-R/L-16-2-T4	●	●	16	21	150	28	4	14.8	12	AGD. -2	2503-M4x10 2503-M4x12 2504-M5x12	AAL-03-3
AIKT-K-R/L-20-2-T4	●	●	20	25	170	30	4	18.3	14			
AIKT-K-R/L-25-2-T6	●	●	25	32	200	40	6	23	18.5			
new AIKT-K-R/L-16-3-T7	●	●	16	25	150	28	7	14.8	15	AGD. -3	2503-M4x12 2504-M5x12 2504-M5x16 2004-M8x1x20	AAL-05-4
AIKT-K-R/L-20-3-T6	●	●	20	27	170	30	6	18.3	16			
AIKT-K-R/L-20-3-T7	●	●	20	25	170	38	7	18.3	13			
AIKT-K-R/L-25-3-T6	●	●	25	32	200	40	6	23	18.5			
AIKT-K-R/L-25-3-T10	●	●	25	32	200	48	10	23	17			
AIKT-K-R/L-32-3-T6	●	●	32	39	250	50	6	30	22			
AIKT-K-R/L-32-3-T12	●	●	32	39	250	53	12	30	22			
AIKT-K-R/L-40-3-T6	●	●	40	47	300	55	6	37.5	26			
AIKT-K-R/L-40-3-T12	●	○	40	48	300	63	12	37.5	27			
AIKT-K-R/L-20-4-T6	●	●	20	27	170	30	6	18.3	16			
AIKT-K-R/L-20-4-T7	●	○	20	25	170	38	7	18.3	13			
AIKT-K-R/L-25-4-T6	●	●	25	32	200	40	6	23	18.5			
AIKT-K-R/L-25-4-T10	●	●	25	32	200	49	10	23	17			
AIKT-K-R/L-32-4-T6	●	●	32	39	250	50	6	30	22			
AIKT-K-R/L-32-4-T12	●	●	32	39	250	53	12	30	22			
AIKT-K-R/L-40-4-T6	●	●	40	47	300	55	6	37.5	26			
AIKT-K-R/L-40-4-T12	●	●	40	48	300	63	12	37.5	27			
AIKT-K-R/L-25-5-T7	●	●	25	33	200	40	7	23	19.5	AGD. -5	2504-M5x16 2004-M8x1x20	
AIKT-K-R/L-32-5-T7	●	●	32	40	250	50	7	30	23			
AIKT-K-R/L-40-5-T7	●	●	40	48	300	55	7	37.5	27			
AIKT-K-R/L-40-5-T12	●	○	40	48	300	63	12	37.5	27			

R: Sağ / Right / Rechts L: Sol / Left / Links

● Stokta / In Stock / Auf Lager ○ Stokta Yok / Non Stock Item / Kein Lagerartikel, Lieferzeit auf Anfrage

AKKO Ucuna Uygunudur. / Compatible with AKKO Insert. / Kompatibel mit AKKO Wendeplatten.

Sipariş Örneği/Ordering Example/Bestellbeispiel

1 ad./pcs./stück AIKT-K-R-16-2-T4

AKKO Ucuna Uygundur. / Compatible with **AKKO** Insert. / Kompatibel mit **AKKO** Wendeplatten.

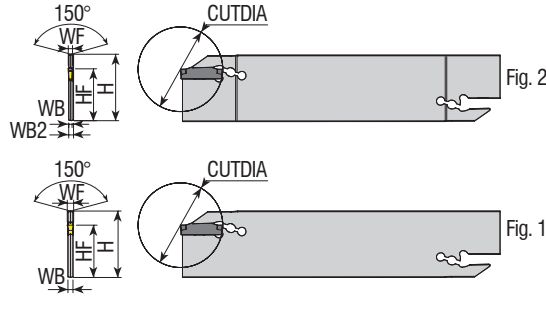

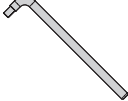



Takım Kodu Ordering Code Bestell-Bezeichnung	Stok Stock Lager	Takım Ölçüleri (mm) Dimension (mm) Abmessung (mm)								Kesici Uç Insert Wendeschneidplatte	Yedek Parçaları / Spare Parts Ersatzteile	
		H	WF	WB2	WB	I	HF	CUTDIA	Fig.		Anahtar Allen Key Innensechskantschlüssel	
AKL-K-32-2	●	32	2	2.40	1.60	150	25	32	2			
AKL-K-32-3	●	32	3	-	2.40	150	25	42	1	AGD. -3		
AKL-K-32-4	●	32	4	-	3.20	150	25	42	1	AGD. -4		

Blok bilgileri için sayfa 155'ye gidin. / For block information, go to page 155. / Informationen zu den spannblock finden Sie auf Seite 155.

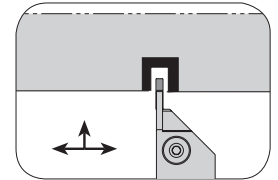
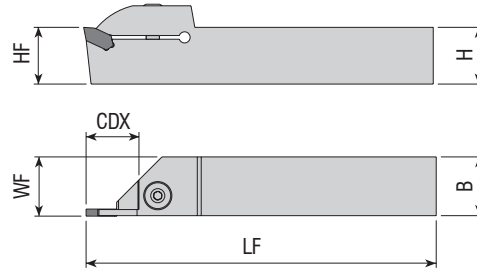
AKKO Ucuna Uygundur. / Compatible with **AKKO** Insert. / Kompatibel mit **AKKO** Wendeplatten.

ARN Ucuna Uygundur. / Compatible with **ARN** Insert. / Kompatibel mit **ARN** Wendeplatten.



Takım Kodu Ordering Code Bestell-Bezeichnung	Stok Stock Lager		Takım Ölçüleri (mm) Dimension (mm) Abmessung (mm)					Kesici Uç Insert Wendeschneidplatte	Yedek Parçaları / Spare Parts / Ersatzteile		
	R	L	HF=H	B	LF	WF	CDX		Sıkma Vidası Screw Klemmschraube	Pul Stamp Ring	Anahtar Allen Key Innensechskantschlüssel
ADKT-ARN-R/L-2020-2-T15	●	●	20	20	125	20.3	15				
ADKT-ARN-R/L-2525-2-T15	●	●	25	25	150	25.3	15	LOMR. - 2	AKV-02-M6x22	ABPL-01	AAL-03-3
ADKT-ARN-R/L-2020-3-T20	●	●	20	20	125	20.4	20	LOMR. - 3	2004-M8x1x20	-	AAL-05-4
ADKT-ARN-R/L-2525-3-T22	●	●	25	25	150	25.4	22				

R: Sağ / Right / Rechts L: Sol / Left / Links

● Stokta / In Stock / Auf Lager ○ Stokta Yok / Non Stock Item / Kein Lagerartikel, Lieferzeit auf Anfrage

ARN Ucuna Uygundur. / Compatible with **ARN** Insert. / Kompatibel mit **ARN** Wendeplatten.

Sipariş Örneği/Ordering Example/Bestellbeispiel

1 ad./pcs./stück AKL-K-32-2

CRTZT Ucuna Uygundur. / Compatible with CRTZT Insert. / Kompatibel mit CRTZT Wendeplatten.

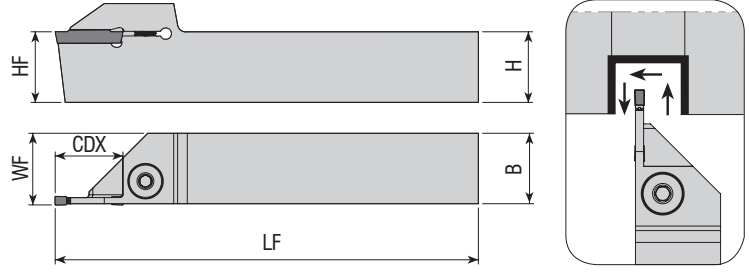

Takım Kodu Ordering Code Bestell-Bezeichnung	Stok Stock Lager		Takım Ölçüleri (mm) Dimension (mm) Abmessung (mm)				Kesici Uç Insert Wendeschneidplatte	Yedek Parçaları / Spare Parts / Ersatzteile			
	R	L	HF=H	B	LF	WF		CDX	Sıkma Vidası Screw Klemmschraube	Pul Stamp Ring	Anahtar Allen Key Innensechskantschlüssel
ADKT-CD-R/L-2020-3-R20	●	○	20	20	125	20.3	20	GX24 0300	2004-M8x1x20	-	AAL-05-4
ADKT-CD-R/L-2525-3-R23	●	○	25	25	150	25.3	23				

CRTZT Ucuna Uygundur. / Compatible with CRTZT Insert. / Kompatibel mit CRTZT Wendeplatten.

HRN Ucuna Uygundur. / Compatible with HRN Insert. / Kompatibel mit HRN Wendeplatten.

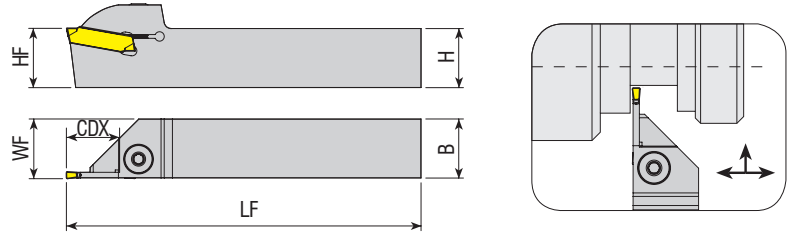

Takım Kodu Ordering Code Bestell-Bezeichnung	Stok Stock Lager		Takım Ölçüleri (mm) Dimension (mm) Abmessung (mm)				Kesici Uç Insert Wendeschneidplatte	Yedek Parçaları / Spare Parts / Ersatzteile			
	R	L	HF=H	B	LF	WF		CDX	Sıkma Vidası Screw Klemmschraube	Pul Stamp Ring	Anahtar Allen Key Innensechskantschlüssel
ADKT-H-R/L-2020-3-T20	●	●	20	20	125	20.5	20	S229 - 3	2004-M8x1x20	-	AAL-05-4
ADKT-H-R/L-2525-3-T22	●	●	25	25	150	25.5	22				
ADKT-H-R/L-2525-3-T26	●	●	25	25	150	25.5	26				
ADKT-H-R/L-2020-4-T20	●	●	20	20	125	20.5	20				
ADKT-H-R/L-2525-4-T22	●	●	25	25	150	25.5	22				
ADKT-H-R/L-3232-4-T22	●	●	32	32	170	32.5	22				
ADKT-H-R/L-2020-5-T20	●	●	20	20	125	20.5	20				
ADKT-H-R/L-2525-5-T25	●	●	25	25	150	25.5	25				
ADKT-H-R/L-2525-6-T25	●	●	25	25	150	25.6	25				

R: Sağ / Right / Rechts L: Sol / Left / Links

● Stokta / In Stock / Auf Lager ○ Stokta Yok / Non Stock Item / Kein Lagerartikel, Lieferzeit auf Anfrage

HRN Ucuna Uygundur. / Compatible with HRN Insert. / Kompatibel mit HRN Wendeplatten.

Sipariş Örneği/Ordering Example/Bestellbeispiel

1 ad./pcs./stück ADKT-CD-R-2020-3-R20

HRN Ucuna Uygun. / Compatible with HRN Insert. / Kompatibel mit HRN Wendeplatten.

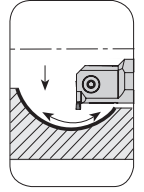
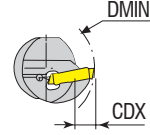
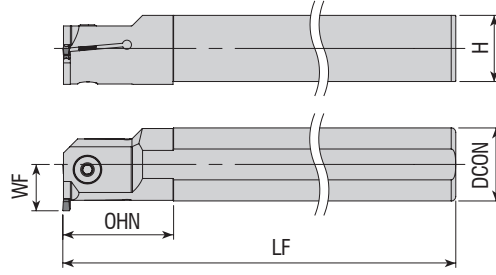

Takım Kodu Ordering Code Bestell-Bezeichnung	Stok Stock Lager		Takım Ölçüleri (mm) Dimension (mm) Abmessung (mm)							Kesici Uç Insert Wendeschneidplatte	Yedek Parçaları / Spare Parts / Ersatzteile		
	R	L	DCON	DMIN	LF	OHN	CDX	H	WF		Sıkma Vidası Screw Klemmschraube	Pul Stamp Ring	Anahtar Allen Key Innensechskantschlüssel
AIKT-H-R/L-25-3-T8	●	●	25	34	200	40	8	23	20.5	S229 - 3	2504-M5x16	AAL-05-4	
AIKT-H-R/L-32-3-T7	●	●	32	40	250	50	7	30	23		2004-M8x1x20		
AIKT-H-R/L-40-3-T7	●	●	40	48	300	55	7	37.5	27		2504-M5x16		
AIKT-H-R/L-25-4-T8	●	●	25	34	200	40	8	23	20.5	S229 - 4	2504-M5x16		
AIKT-H-R/L-32-4-T7	●	●	32	40	250	50	7	30	23		2004-M8x1x20		
AIKT-H-R/L-40-4-T7	●	●	40	48	300	55	7	37.5	27	S229 - 5	2504-M5x16		
AIKT-H-R/L-25-5-T8	●	●	25	34	200	40	8	23	20.5		2004-M8x1x20		
AIKT-H-R/L-32-5-T7	●	○	32	40	250	50	7	30	23		2004-M8x1x20		
AIKT-H-R/L-40-5-T7	●	○	40	48	300	55	7	37.5	27				

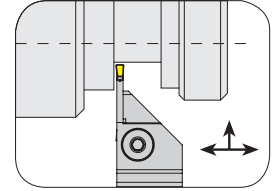
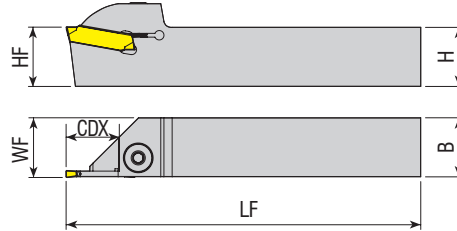

Takım Kodu Ordering Code Bestell-Bezeichnung	Stok Stock Lager		Takım Ölçüleri (mm) Dimension (mm) Abmessung (mm)					Kesici Uç Insert Wendeschneidplatte	Yedek Parçaları / Spare Parts / Ersatzteile			
	R	L	HF=H	B	LF	WF	CDX		Sıkma Vidası Screw Klemmschraube	Pul Stamp Ring	Anahtar Allen Key Innensechskantschlüssel	
ADKT-HK-R/L-1616-2-T15	●	●	16	16	125	16.3	15	S224 - 2	AKV-02-M6x22	ABPL-01	AAL-03-3	
ADKT-HK-R/L-2020-2-T15	●	●	20	20	125	20.3	15		S224 - 3	2004-M8x1x20	-	AAL-05-4
ADKT-HK-R/L-2525-2-T15	●	●	25	25	150	25.3	15					
ADKT-HK-R/L-1616-3-T15	○	○	16	16	125	16.3	15					
ADKT-HK-R/L-2020-3-T20	●	●	20	20	125	20.4	20					
ADKT-HK-R/L-2525-3-T22	●	●	25	25	150	25.4	22					
ADKT-HK-R/L-2020-4-T20	●	●	20	20	125	20.4	20	S224 - 4				
ADKT-HK-R/L-2525-4-T22	●	●	25	25	150	25.4	22					
ADKT-HS223-R/L-2020-2-T15	●	○	20	20	125	20.4	15	S223 - 2	AKV-02-M6x22	ABPL-01	AAL-03-3	
ADKT-HS223-R/L-2020-3-T17	●	○	20	20	125	20.3	17	S223 - 3	2004-M8x1x20	-	AAL-05-4	

R: Sağ / Right / Rechts/ L: Sol / Left / Links

● Stokta / In Stock / Auf Lager ○ Stokta Yok / Non Stock Item / Kein Lagerartikel, Lieferzeit auf Anfrage

HRN Ucuna Uygun. / Compatible with HRN Insert. / Kompatibel mit HRN Wendeplatten.

Sipariş Örneği/Ordering Example/Bestellbeispiel

1 ad./pcs./stück AIKT-H-R/L-25-3-T8

HRN Ucuna Uygundur. / Compatible with HRN Insert. / Kompatibel mit HRN Wendeplatten.

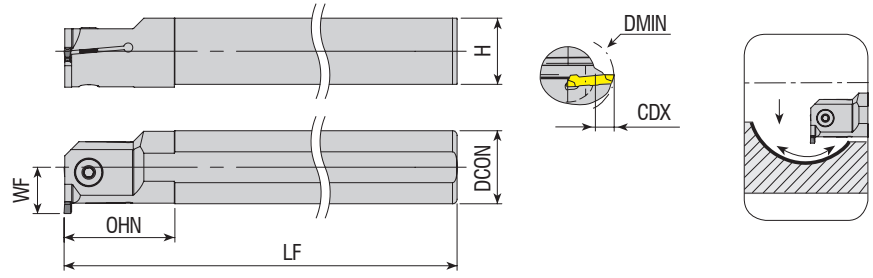

Takım Kodu Ordering Code Bestell-Bezeichnung	Stok Stock Lager		Takım Ölçüleri (mm) Dimension (mm) Abmessung (mm)							Kesici Uç Insert Wendeschneidplatte	Yedek Parçaları / Spare Parts / Ersatzteile		
	R	L	DCON	DMIN	LF	OHN	CDX	H	WF		Sıkma Vidası Screw Klemmschraube	Anahtar Allen Key Innensechskantschlüssel	
AIKT-HK-R/L-20-2-T6	●	●	20	26	170	30	6	18.3	16	S224 - 2	2503-M4x12	AAL-03-3	
AIKT-HK-R/L-25-2-T6	●	○	25	32	200	40	6	23	18.5		2504-M5x16		
AIKT-HK-R/L-20-3-T6	●	○	20	27	170	30	6	18.3	16	S224 - 3	2504-M5x12	AAL-05-4	
AIKT-HK-R/L-25-3-T6	●	●	25	32	200	40	6	23	18.5		2504-M5x16		
AIKT-HK-R/L-32-3-T6	●	●	32	39	250	50	6	30	22	S224 - 4	2004-M8x1x20	AAL-05-4	
AIKT-HK-R/L-20-4-T6	●	○	20	27	170	30	6	18.3	16		2504-M5x12		
AIKT-HK-R/L-25-4-T6	●	○	25	32	200	40	6	23	18.5	S224 - 4	2504-M5x16	AAL-05-4	
AIKT-HK-R/L-32-4-T6	●	○	32	39	250	50	6	30	22		2004-M8x1x20		
AIKT-HS223-R/L-20-2-T5	●	○	20	26	170	33	5	18.3	15	S223 - 2	2503-M4x12	AAL-03-3	
AIKT-HS223-R/L-25-2-T5	●	○	25	31	200	40	5	23	17.5		2504-M5x16		
AIKT-HS223-R/L-20-3-T6	●	○	20	27	170	33	6	18.3	16	S223 - 3	2504-M5x12	AAL-05-4	
AIKT-HS223-R/L-25-3-T6	●	○	25	32	200	40	6	23	18.5		2504-M5x16		

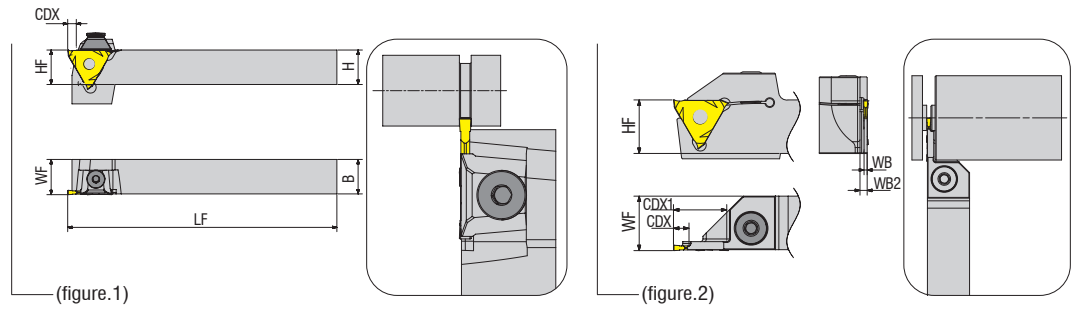

Takım Kodu Ordering Code Bestell-Bezeichnung	Stok Stock Lager		Takım Ölçüleri (mm) Dimension (mm) Abmessung (mm)								Kesici Uç Insert Wendeschneidplatte	Figür Figure Figur	Yedek Parçaları / Spare Parts / Ersatzteile				
	R	L	HF=H	B	LF	WF	WB	WB2	CDX	CDX1			Sıkma Vidası Screw Klemmschraube	Baskı Pabucu Wedge Clamp Spannpratze	Segman Ring Feder	Anahtar Allen Key Innensechskantschlüssel	
ADKT-H22-R/L-1616-(0.5-2)-T4	●	●	16	16	125	16.35	-	-	4	-	S312 - (0.5-2)	figure.1	AKV-29-M6x29	AKK-04	AS-01	AAL-03-3	
ADKT-H22-R/L-2020-(0.5-2)-T4	●	●	20	20	125	20.35	-	-	4	-			figure.2	2004-M8x1x20	-	-	AAL-05-4
ADKT-H22-R/L-2020-(0.5-2)-T6x20	●	○	20	20	125	20.2	1.3	3	6	20			figure.1	AKV-29-M6x29	AKK-04	AS-01	AAL-03-3
ADKT-H22-R/L-2525-(0.5-2)-T4	●	●	25	25	150	25.35	-	-	4	-			figure.1	AKV-29-M6x29	AKK-04	AS-01	AAL-03-3
ADKT-H22-R/L-2525-(0.5-2)-T6x20	●	○	25	25	150	20.2	1.3	3	6	20			figure.2	2004-M8x1x20	-	-	AAL-05-4

R: Sağ / Right / Rechts L: Sol / Left / Links

● Stokta / In Stock / Auf Lager ○ Stokta Yok / Non Stock Item / Kein Lagerartikel, Lieferzeit auf Anfrage

HRN Ucuna Uygundur. / Compatible with HRN Insert. / Kompatibel mit HRN Wendeplatten.

Sipariş Örneği/Ordering Example/Bestellbeispiel

1 ad./pcs./stück AIKT-HK-R-20-2-T6

ISCR Ucuna Uygundur. / Compatible with ISCR Insert. / Kompatibel mit ISCR Wendeplatten.

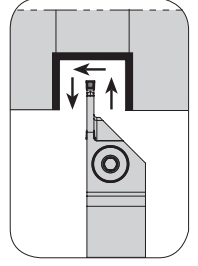
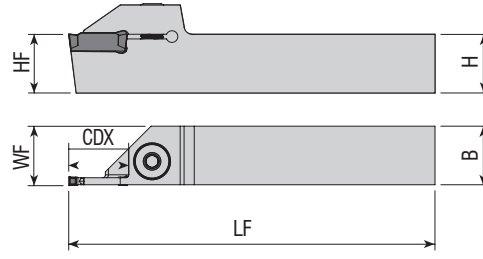

Takım Kodu Ordering Code Bestell-Bezeichnung	Stok Stock Lager		Takım Ölçüleri (mm) Dimension (mm) Abmessung (mm)				Kesici Uç Insert Wendescheidplatte	Yedek Parçaları / Spare Parts / Ersatzteile			
	R	L	HF=H	B	LF	WF		CDX	Sıkma Vidası Screw Klemmschraube	Pul Stamp Ring	Anahtar Allen Key Innensechskantschlüssel
ADKT-I-R/L-1212-2-T15	●	●	12	12	100	16.3	15	DGN - 2	AKV-02-M6x22	ABPL-01	AAL-03-3
ADKT-I-R/L-1616-2-T15	●	●	16	16	125	16.3	15				
ADKT-I-R/L-2020-2-T15	●	●	20	20	125	20.3	15				
ADKT-I-R/L-2525-2-T15	●	●	25	25	150	25.3	15				
ADKT-I-R/L-3232-2-T15	●	●	32	32	170	32.3	15				
ADKT-I-R/L-1212-3-T15	●	●	12	12	100	16.3	15	DGN - 3			
ADKT-I-R/L-1616-3-T15	●	●	16	16	125	16.3	15				
ADKT-I-R/L-2020-3-T12	●	●	20	20	125	20.3	12				
ADKT-I-R/L-2020-3-T20	●	●	20	20	125	20.3	20				
ADKT-I-R/L-2525-3-T12	●	●	25	25	150	25.3	12				
ADKT-I-R/L-2525-3-T22	●	●	25	25	150	25.3	22	DGN / GRP - 4	2004-M8x1x20	-	AAL-05-4
ADKT-I-R/L-3232-3-T22	●	●	32	32	170	32.3	22				
ADKT-I-R/L-2020-4-T20	●	●	20	20	125	20.4	20				
ADKT-I-R/L-2525-4-T12	●	●	25	25	150	25.4	12				
ADKT-I-R/L-2525-4-T22	●	●	25	25	150	25.4	22				
ADKT-I-R/L-3232-4-T25	●	●	32	32	170	32.4	25	DGN / GRP - 5			
ADKT-I-R/L-2020-5-T20	●	●	20	20	125	20.5	20				
ADKT-I-R/L-2525-5-T12	●	●	25	25	150	25.5	12				
ADKT-I-R/L-2525-5-T25	●	●	25	25	150	25.5	25				
ADKT-IG-R/L-1616-3-T18	●	○	16	16	125	16.3	18				
ADKT-IG-R/L-2020-3-T12	●	●	20	20	125	20.3	12				
ADKT-IG-R/L-2020-3-R20	●	●	20	20	125	20.3	20				
ADKT-IG-R/L-2525-3-T12	●	●	25	25	150	25.3	12				
ADKT-IG-R/L-2525-3-T22	●	●	25	25	150	25.3	22				
ADKT-IGI-R/L-2020-2-T15	●	●	20	20	125	20.3	15	GIM / GIP - 2	AKV-02-M6x22	ABPL-01	AAL-03-3
ADKT-IGI-R/L-2525-2-T15	●	●	25	25	150	25.3	15				
ADKT-IGI-R/L-1616-3-T15	●	●	16	16	125	16.3	15	GIM / GIP - 3			
ADKT-IGI-R/L-2020-3-T20	●	●	20	20	125	20.3	20				
ADKT-IGI-R/L-2525-3-T9	●	●	25	25	150	25.3	9				
ADKT-IGI-R/L-2525-3-T22	●	●	25	25	150	25.3	22				
ADKT-IGI-R/L-2525-4-T22	●	●	25	25	150	25.4	22				
ADKT-IGI-R/L-2525-5-T25	●	●	25	25	150	25.5	25	GIM / GIP - 4	2004-M8x1x20	-	
ADKT-IGI-R/L-2525-8-T25	●	○	25	25	150	25.8	25				
ADKT-IGI-R/L-2525-8-T30	●	○	25	25	150	25.8	30	GIM / GIP - 8	2505-M6x20		AAL-07-5 AAL-03-3
ADKT-IGI-R/L-2525-5-T25	●	●	25	25	150	25.6	25				
ADKT-IGTN-R/L-2525-5-T25	●	●	25	25	150	25.6	25	GTN - 5	2004-M8x1x20		
ADKT-IDC-R/L-1616-2-D35	○	●	16	16	140	16.2	35	DCE - 2	2503-M4x19	ABPL-01	AAL-05-4 AAL-03-3
ADKT-IDC-R/L-2020-2-R23	●	○	20	20	125	20.2	23				
ADKT-IDC-R/L-2525-2-R23	●	○	25	25	150	25.2	23	DCE - 3	AKV-02-M6x22		AAL-03-3
ADKT-IDC-R/L-1616-3-D35	●	○	16	16	140	16.3	35				
ADKT-IDC-R/L-2525-3-T21	●	○	25	25	150	25.4	21		2504-M5x18		
									2004-M8x1x20	-	AAL-05-4

R: Sağ / Right / Rechts L: Sol / Left / Links

● Stokta / In Stock / Auf Lager ○ Stokta Yok / Non Stock Item / Kein Lagerartikel, Lieferzeit auf Anfrage

ISCR Ucuna Uygundur. / Compatible with ISCR Insert. / Kompatibel mit ISCR Wendeplatten.

Sipariş Örneği/Ordering Example/Bestellbeispiel

1 ad./pcs./stück ADKT-I-R-1212-2-T15

ISCR Ucuna Uygunur. / Compatible with ISCR Insert. / Kompatibel mit ISCR Wendeplatten.

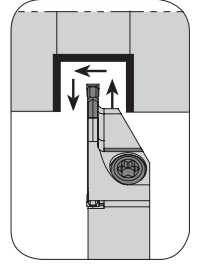
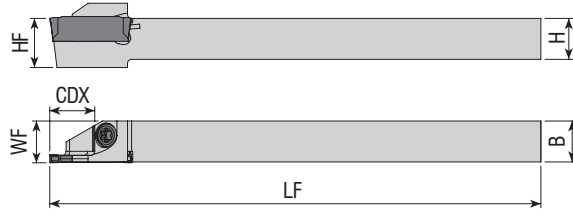

Takım Kodu Ordering Code Bestell-Bezeichnung	Stok Stock Lager		Takım Ölçüleri (mm) Dimension (mm) Abmessung (mm)					Kesici Uç Insert Wendeschneidplatte	Yedek Parçaları / Spare Parts / Ersatzteile			
	R	L	HF=H	B	LF	WF	CDX		Sıkma Vidası Screw Klemmschraube	Pul Stamp Ring	Tork Anahtar Torx Key Torx Innensechskantschlüssel	
ADKT-I-R/L-0808-2-R10-S	●	●	08	08	100	8.2	10	DGN - 2	4015-M4x11	-	80-T15	
ADKT-I-R/L-1010-2-R10-K-S	●	●	10	10	125	10.2	10					
ADKT-I-R/L-1212-2-R12-K-S	●	●	12	12	125	12.2	12					
ADKT-I-R/L-1616-2-R16-K-S	●	○	16	16	125	16.2	16	DGN - 3				
ADKT-I-R/L-1616-3-R16-K-S	●	●	16	16	125	16.3	16					

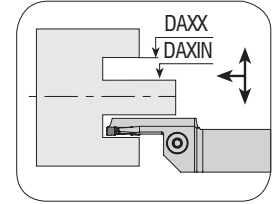
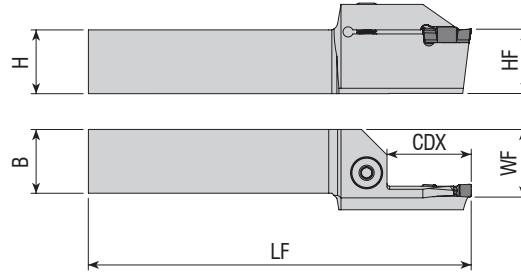

Takım Kodu Ordering Code Bestell-Bezeichnung	Stok Stock Lager		Takım Ölçüleri (mm) Dimension (mm) Abmessung (mm)							Kesici Uç Insert Wendeschneidplatte	Yedek Parçaları / Spare Parts / Ersatzteile			
	R	L	HF=H	B	LF	WF	CDX	DAXIN	DAXX		Sıkma Vidası Screw Klemmschraube	Pul Stamp Ring	Anahtar Allen Key Innensechskantschlüssel	
AAKT-IG-R/L-2525-40-60-4-T25	●	●	25	25	150	26.5	25	40	60	DGN / GRP - 4	2004-M8x1x20	-	AAL-05-4	
AAKT-IG-R/L-2525-52-80-4-T25	●	●	25	25	150	26.5	25	52	80					
AAKT-IG-R/L-2525-70-110-4-T28	●	●	25	25	150	26.5	28	70	110					
AAKT-IG-R/L-2525-72-110-4-T25	○	○	25	25	150	26.5	25	72	110					
AAKT-IG-R/L-2525-100-150-4-T25	●	○	25	25	150	26.5	25	100	150					
AAKT-IG-R/L-2525-110-200-4-T28	●	○	25	25	150	26.5	28	110	200					
AAKT-IG-R/L-2525-110-200-4-T32	●	●	25	25	150	26.5	32	110	200					
AAKT-IG-R/L-2525-140-200-4-T25	○	○	25	25	150	26.5	25	140	200					
AAKT-IG-R/L-2525-180-800-4-T28	●	●	25	25	150	26.5	28	180	800					
AAKT-IG-R/L-2525-200-800-4-T25	○	○	25	25	150	26.5	25	200	800					
AAKT-IG-R/L-2525-70-110-5-T32	●	●	25	25	150	26.5	32	70	110	DGN / GRP - 5				
AAKT-IG-R/L-2525-110-200-5-T9	●	○	25	25	150	26.5	9	110	200					
AAKT-IG-R/L-2525-110-200-5-T32	●	●	25	25	150	26.5	32	110	200					
AAKT-IG-R/L-2525-180-800-5-T32	●	●	25	25	150	26.5	32	180	800	DGN / GRP - 6				
AAKT-IG-R/L-2525-58-100-6-T32	●	○	25	25	150	26.5	32	58	100					
AAKT-IG-R/L-2525-88-180-6-T32	●	○	25	25	150	26.5	32	88	180					

R: Sağ / Right / Rechts/ L: Sol / Left / Links

● Stokta / In Stock / Auf Lager ○ Stokta Yok / Non Stock Item / Kein Lagerartikel, Lieferzeit auf Anfrage

ISCR Ucuna Uygunur. / Compatible with ISCR Insert. / Kompatibel mit ISCR Wendeplatten.

Sipariş Örneği/Ordering Example/Bestellbeispiel

1 ad./pcs./stück ADKT-I-R-0808-2-R10-S

ISCR Ucuna Uygundur. / Compatible with ISCR Insert. / Kompatibel mit ISCR Wendeplatten.

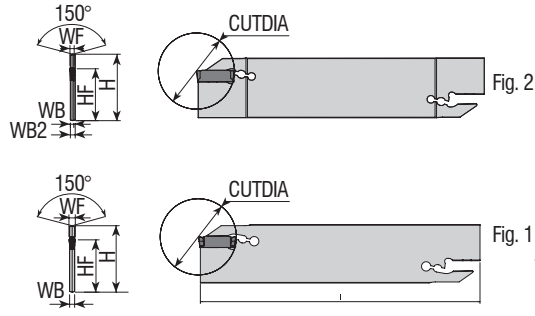

Takım Kodu Ordering Code Bestell-Bezeichnung	Stok Stock Lager	Takım Ölçüleri (mm) Dimension (mm) Abmessung (mm)								Kesici Uç Insert Wendescheidplatte	Yedek Parçaları / Spare Parts Ersatzteile	
		H	WF	WB2	WB	I	HF	CUTDIA	Fig.		Anahtar Allen Key Innensechskantschlüssel	
AKL-I-26-2	●	26	1.9-2.5	1.6	-	110	21.4	39	1	DGN - 2	ALA-02	
AKL-I-32-2	●	32	1.9-2.5	1.6	2.4	150	25	39	2			
AKL-I-26-3	●	26	3-3.18	2.4	-	110	21.4	39	1	DGN - 3	ALA-02	
AKL-I-32-3	●	32	3-3.18	2.4	-	150	25	39	1			
AKL-I-26-4	●	26	4	3.2	-	110	21.4	80	1	DGN / GRP - 4	ALA-02	
AKL-I-32-4	●	32	4	3.2	-	150	25	100	1			

Blok bilgileri için sayfa 155'ye gidin. / For block information, go to page 155.
Informationen zu den spannblock finden Sie auf Seite 155.

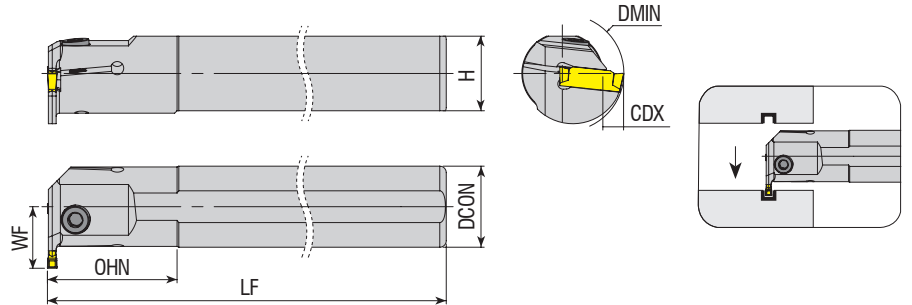

Takım Kodu Ordering Code Bestell-Bezeichnung	Stok Stock Lager		Takım Ölçüleri (mm) Dimension (mm) Abmessung (mm)							Kesici Uç Insert Wendescheidplatte	Yedek Parçaları / Spare Parts / Ersatzteile	
	R	L	DCON	DMIN	LF	OHN	CDX	H	WF		Sıkma Vidası Screw Klemmschraube	Anahtar Allen Key Innensechskantschlüssel
AIKT-I-R/L-20-3-T5	●	●	20	26	170	25	5	18.3	15.5	DGN - 3	2504-M5x12	AAL-05-4
AIKT-I-R/L-25-3-T6	●	●	25	32	200	40	6	23	19		2504-M5x16	

R: Sağ / Right / Rechts L: Sol / Left / Links

● Stokta / In Stock / Auf Lager ○ Stokta Yok / Non Stock Item / Kein Lagerartikel. Lieferzeit auf Anfrage

ISCR Ucuna Uygundur. / Compatible with ISCR Insert. / Kompatibel mit ISCR Wendeplatten.

Sipariş Örneği/Ordering Example/Bestellbeispiel

1 ad./pcs./stück AKL-I-26-2

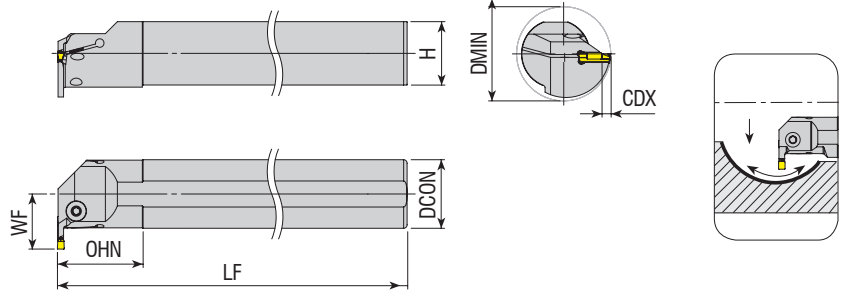

Takım Kodu Ordering Code Bestell-Bezeichnung	Stok Stock Lager		Takım Ölçüleri (mm) Dimension (mm) Abmessung (mm)							Kesici Uç Insert Wendescheidplatte	Yedek Parçaları / Spare Parts / Ersatzteile		
	R	L	DCON	DMIN	LF	OHN	CDX	H	WF		Sıkma Vidası Screw Klemmschraube	Anahtar Allen Key Innensechskantschlüssel	
AIKT-IG-R/L-25-4-T10-H	●	●	25	36	200	40	10	23	22.7	DGN / GRP - 4	2504-M5X16	AAL-05-4	
AIKT-IG-R/L-32-4-T10-H	●	●	32	43	250	45	10	30	26.2		2004-M8x1x20		
AIKT-IG-R/L-40-4-T12-H	●	●	40	53	250	50	12	37.5	32.2				
AIKT-IG-R/L-25-5-T10-H	●	○	25	43	200	40	10	23	22.7	DGN / GRP - 5	2504-M5X16		
AIKT-IG-R/L-32-5-T10-H	●	○	32	43	250	45	10	30	26.2		2004-M8x1x20		
AIKT-IG-R/L-40-5-T12-H	●	○	40	53	250	50	12	37.5	32.2				
AIKT-IG-R/L-50-5-T12-H	●	○	50	63	300	60	12	47	37.2				

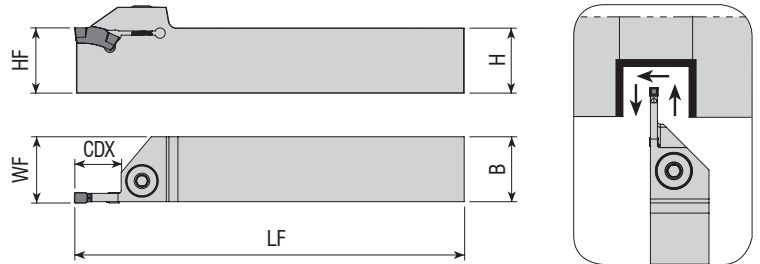

Takım Kodu Ordering Code Bestell-Bezeichnung	Stok Stock Lager		Takım Ölçüleri (mm) Dimension (mm) Abmessung (mm)					Kesici Uç Insert Wendescheidplatte	Yedek Parçaları / Spare Parts / Ersatzteile				
	R	L	HF=H	B	LF	WF	CDX		Sıkma Vidası Screw Klemmschraube	Pul Stamp Ring	Anahtar Allen Key Innensechskantschlüssel		
ADKT-ITG-R/L-2020-3-T8	●	●	20	20	125	20.3	8	TGM. - 3	2004-M8x1x20	-	AAL-05-4		
ADKT-ITG-R/L-2525-3-T8	●	●	25	25	150	25.3	8						
ADKT-ITG-R/L-3232-3-T8	●	○	32	32	170	32.3	8						
ADKT-ITG-R/L-2020-4-T9	●	●	20	20	125	20.4	9	TGM. - 4					
ADKT-ITG-R/L-2525-4-T17	●	●	25	25	150	25.4	17						
ADKT-ITG-R/L-3232-4-T17	●	●	32	32	170	32.4	17						
ADKT-ITG-R/L-3232-5-T25	●	○	32	32	170	32.5	25		TGM. - 5				

R: Sağ / Right / Rechts L: Sol / Left / Links
● Stokta / In Stock / Auf Lager ○ Stokta Yok / Non Stock Item / Kein Lagerartikel, Lieferzeit auf Anfrage
ISCR Ucuna Uygundur. / Compatible with ISCR Insert. / Kompatibel mit ISCR Wendeplatten.

Sipariş Örneği/Ordering Example/Bestellbeispiel
1 ad./pcs./stück AIKT-IG-R-25-4-T10-H

ISCR Ucuna Uygundur. / Compatible with ISCR Insert. / Kompatibel mit ISCR Wendeplatten.

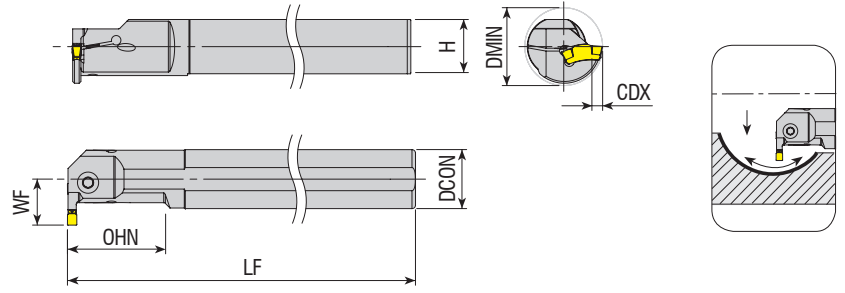

Takım Kodu Ordering Code Bestell-Bezeichnung	Stok Stock Lager		Takım Ölçüleri (mm) Dimension (mm) Abmessung (mm)							Kesici Uç Insert Wendeschneidplatte	Yedek Parçaları / Spare Parts / Ersatzteile	
	R	L	DCON	DMIN	LF	OHN	CDX	H	WF	Sıkma Vidası Screw Klemmschraube	Tork Anahtar Torx Key Torx Innensechskantschlüssel	
AIKT-ITG-R/L-16-3-T6-H	●	●	16	20	150	25	6	14.8	12	TGM. - 3	1020-M4.5X14	80-T20
AIKT-ITG-R/L-20-3-T6-H	●	●	20	25	170	32	6	18.3	14.2		1020-M4.5X16	
AIKT-ITG-R/L-25-3-T8-H	●	●	25	32	200	40	8	23	18.8		2504-M5X16	AAL-05-4
AIKT-ITG-R/L-32-3-T8-H	●	●	32	38	250	49	8	30	22		2004-M8x1x20	
AIKT-ITG-R/L-20-4-T6-H	●	●	20	25	170	33	6	18.3	14.2	TGM. - 4	1020-M4.5X16	80-T20
AIKT-ITG-R/L-25-4-T7-H	●	●	25	31	200	41	7	23	17.5		2504-M5X16	AAL-05-4
AIKT-ITG-R/L-25-4-T9-H	●	●	25	32.5	200	41	9	23	19.5			
AIKT-ITG-R/L-32-4-T11-H	●	●	32	42	250	50	11	30	25.5	TGM. - 6.35	2004-M8x1x20	
AIKT-ITG-R/L-40-4-T11-H	●	●	40	53	300	50	11	37.5	32			
AIKT-ITG-R/L-32-6.35-T17.5-H	●	●	32	57	250	50	17.5	30	29			

R: Sağ / Right / Rechts L: Sol / Left / Links

● Stokta / In Stock / Auf Lager ○ Stokta Yok / Non Stock Item / Kein Lagerartikel, Lieferzeit auf Anfrage

ISCR Ucuna Uygundur. / Compatible with ISCR Insert. / Kompatibel mit ISCR Wendeplatten.

Sipariş Örneği/Ordering Example/Bestellbeispiel
1 ad./pcs./stück AIKT-ITG-R-16-3-T6-H



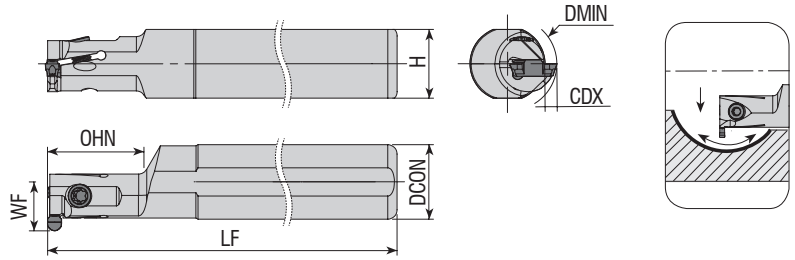

Takım Kodu Ordering Code Bestell-Bezeichnung	Stok Stock Lager		Takım Ölçüleri (mm) Dimension (mm) Abmessung (mm)							Kesici Uç Insert Wendeschneidplatte	Yedek Parçaları / Spare Parts / Ersatzteile	
	R	L	DCON	DMIN	LF	OHN	CDX	H	WF		Sıkma Vidası Screw Klemmschraube	Tork Anahtar Torx Key Torx Innensechskantschlüssel
AIKT-IGE-R/L-10-2-T3-H	●	○	10	11.5	125	25	3	9	8.3	GEPI - 2	3008-M3x8	82-T08
AIKT-IGE-R/L-16-2-T3-D11.5	●	○	16	11.5	125	20	3	14.8	11.1			
AIKT-IGE-R/L-16-2-T3-D11.5-H	●	○	16	11	125	22	3	14.8	11			
AIKT-IGE-R/L-16-2-T2.5-H	●	●	16	13	125	20	2.5	14.8	10.5	GEPI - 3	1315-M4x11	82-T15
AIKT-IGE-R/L-20-2-T4-H	●	○	20	20	170	41	4	18.3	14			
AIKT-IGE-R/L-16-3-T2.5-H	●	○	16	13	125	20	2.5	14.8	10.5			
AIKT-IGE-R/L-16-3-T2.5-D20	●	○	16	20	125	28	2.5	14.8	10.5			80-T15

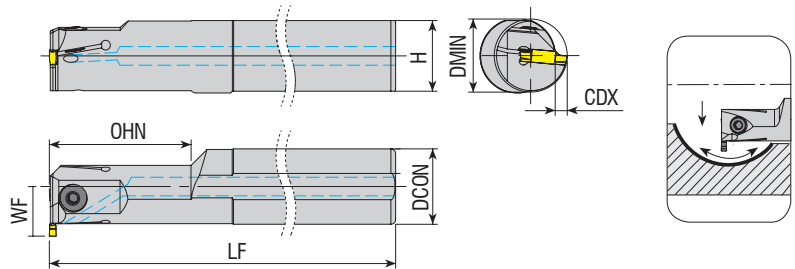

Takım Kodu Ordering Code Bestell-Bezeichnung	Stok Stock Lager		Takım Ölçüleri (mm) Dimension (mm) Abmessung (mm)							Kesici Uç Insert Wendeschneidplatte	Yedek Parçaları / Spare Parts / Ersatzteile	
	R	L	DCON	DMIN	LF	OHN	CDX	H	WF		Sıkma Vidası Screw Klemmschraube	Tork Anahtar Torx Key Innensechskantschlüssel Anahtar Allen Key Innensechskantschlüssel
AIKT-IGI-R/L-20-3-T4	●	●	20	20	170	25	4	18.3	14.5	GIMIY / GIPI - 3	1020-M5x14	80-T20
AIKT-IGI-R/L-25-3-T5	●	●	25	23	200	30	5	23	17			
AIKT-IGI-R/L-32-3-T5	●	●	32	31	250	30	5	30	21			
AIKT-IGI-R/L-40-3-T5	●	○	40	50	300	50	5	37.5	25		2004-M8x1x20	AAL-05-4
AIKT-IGI-R/L-20-4-T4	●	●	20	20	170	25	4	18.3	14.5	GIMIY / GIPI - 4	1020-M5x14	80-T20
AIKT-IGI-R/L-25-5-T10	●	○	25	32	200	25	10	23	22.5	GIMIY / GIPI - 5	2504-M5x16	AAL-05-4
AIKT-IGI-R/L-25-5-T10-H	●	○	25	32	200	25	10	23	22.5			
AIKT-IGI-R/L-25-5-T15	●	○	25	37	200	25	15	23	27.5			
AIKT-IGI-R/L-25-5-T15-H	●	○	25	37	200	25	15	23	27.5			

R: Sağ / Right / Rechts L: Sol / Left / Links

● Stokta / In Stock / Auf Lager ○ Stokta Yok / Non Stock Item / Kein Lagerartikel, Lieferzeit auf Anfrage

ISCR Ucuna Uygundur. / Compatible with ISCR Insert. / Kompatibel mit ISCR Wendeplatten.

Sipariş Örneği/Ordering Example/Bestellbeispiel
1 ad./pcs./stück AIKT-IGE-R-10-2-T3-H

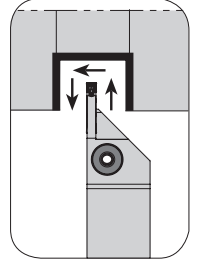
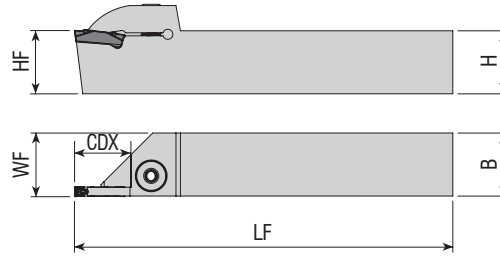

Takım Kodu Ordering Code Bestell-Bezeichnung	Stok Stock Lager		Takım Ölçüleri (mm) Dimension (mm) Abmessung (mm)				Kesici Uç Insert Wendeschneidplatte	Yedek Parçaları / Spare Parts / Ersatzteile			
	R	L	HF=H	B	LF	WF		CDX	Sıkma Vidası Screw Klemmschraube	Pul Stamp Ring	Anahtar Allen Key Innensechskantschlüssel
ADKT-KM-R/L-2020-2-T15	●	●	20	20	125	20.3	15		AKV-02-M6x22	ABPL-01	AAL-03-3
ADKT-KM-R/L-2525-2-T15	●	●	25	25	150	25.3	15		AKV-02-M6x22	ABPL-01	AAL-03-3
ADKT-KM-R/L-2020-3-T20	●	●	20	20	125	20.4	20		2004-M8x1x20	-	AAL-05-4
ADKT-KM-R/L-2525-3-T22	●	●	25	25	150	25.4	22		2004-M8x1x20	-	AAL-05-4
ADKT-KM-R/L-2525-4-T22	●	●	25	25	150	25.5	22		2004-M8x1x20	-	AAL-05-4

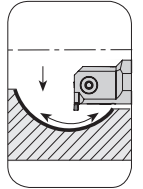
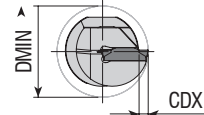
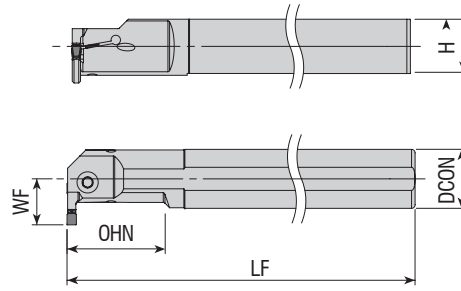

Takım Kodu Ordering Code Bestell-Bezeichnung	Stok Stock Lager		Takım Ölçüleri (mm) Dimension (mm) Abmessung (mm)						Kesici Uç Insert Wendeschneidplatte	Yedek Parçaları / Spare Parts / Ersatzteile		
	R	L	DCON	DMIN	LF	OHN	CDX	H		WF	Sıkma Vidası Screw Klemmschraube	Anahtar Allen Key Innensechskantschlüssel
AIKT-KM-R/L-20-2-T7	●	●	20	25	170	40	7	18.3	13		2503-M4x12	AAL-03-3
AIKT-KM-R/L-20-3-T7	●	○	20	25	170	40	7	18.3	13		2504-M5x12	AAL-05-4
AIKT-KM-R/L-25-3-T10	●	●	25	32	200	50	10	23	17		2505-M6x16	AAL-07-5
AIKT-KM-R/L-32-3-T12	●	●	32	40	250	64	12	30	22		2505-M6x16	AAL-07-5
AIKT-KM-R/L-40-3-T12	●	●	40	48	300	80	12	37.5	27		2505-M6x20	AAL-07-5
AIKT-KM-R/L-20-4-T7	●	○	20	25	170	40	7	18.3	13		2504-M5x12	AAL-05-4
AIKT-KM-R/L-32-4-T12.2-H	●	○	32	40	190	104	12.2	31	22		2504-M5x14	AAL-05-4

R: Sağ / Right / Rechts L: Sol / Left / Links

● Stokta / In Stock / Auf Lager ○ Stokta Yok / Non Stock Item / Kein Lagerartikel, Lieferzeit auf Anfrage

KNMTL Ucuna Uygundur. / Compatible with KNMTL Insert. / Kompatibel mit KNMTL Wendeplatten.

Sipariş Örneği/Ordering Example/Bestellbeispiel

1 ad./pcs./stück ADKT-KM-R-2020-2-T15

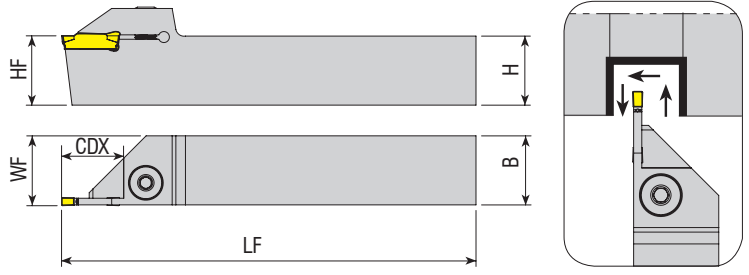

Takım Kodu Ordering Code Bestell-Bezeichnung	Stok Stock Lager		Takım Ölçüleri (mm) Dimension (mm) Abmessung (mm)					Kesici Uç Insert Wendeschneidplatte	Yedek Parçaları / Spare Parts / Ersatzteile			
	R	L	HF=H	B	LF	WF	CDX		Sıkma Vidası Screw Klemmschraube	Pul Stamp Ring	Anahtar Allen Key Innensechskantschlüssel	
ADKT-K-R/L-1212-1.5-T15	●	●	12	12	100	12.2	15	MGM. - 1.5	AKV-02-M6x22	ABPL-01	AAL-03-3	
ADKT-K-R/L-2020-1.5-T15	●	●	20	20	125	20.2	15					
ADKT-K-R/L-1212-2-T15	●	●	12	12	100	16.3	15					
ADKT-K-R/L-1616-2-T10	●	●	16	16	125	16.3	10					
ADKT-K-R/L-1616-2-T15	●	●	16	16	125	16.3	15					
ADKT-K-R/L-2020-2-T15	●	●	20	20	150	20.3	15					
ADKT-K-R/L-2525-2-T15	●	●	25	25	150	25.3	15					
ADKT-K-R/L-3232-2-T15	●	●	32	32	170	32.3	15					
ADKT-K-R/L-1212-3-T15	●	●	12	12	100	12.3	15					
new ADKT-K-R/L-1616-3-T7	●	●	16	16	125	16.3	7					
ADKT-K-R/L-1616-3-T15	●	●	16	16	125	16.3	15					
ADKT-K-R/L-2020-3-T10	●	●	20	20	125	20.3	10					
ADKT-K-R/L-2020-3-T20	●	●	20	20	125	20.3	20					
ADKT-K-R/L-2020-3-R28	●	●	20	20	125	20.3	28					
ADKT-K-R/L-2525-3-T10	●	●	25	25	150	25.3	10					
ADKT-K-R/L-2525-3-R15	●	●	25	25	150	25.3	15					
ADKT-K-R/L-2525-3-T22	●	●	25	25	150	25.3	22					
new ADKT-K-R/L-2525-3-T30	●	●	16	16	150	25.3	30					
ADKT-K-R/L-3232-3-T10	●	●	32	32	170	32.3	10					
ADKT-K-R/L-3232-3-T22	●	●	32	32	170	32.3	22					
ADKT-K-R/L-2020-4-T10	●	●	20	20	125	20.4	10					
ADKT-K-R/L-2020-4-T20	●	●	20	20	125	20.4	20					
ADKT-K-R/L-2020-4-R25	●	○	20	20	125	20.4	25					
ADKT-K-R/L-2525-4-T10	●	●	25	25	150	25.4	10					
ADKT-K-R/L-2525-4-T18	●	●	25	25	150	25.4	18					
ADKT-K-R/L-2525-4-T22	●	●	25	25	150	25.4	22					
ADKT-K-R/L-3232-4-T10	●	●	32	32	170	32.4	10					
ADKT-K-R/L-3232-4-T22	●	●	32	32	170	32.4	22					
ADKT-K-R/L-2020-5-T20	●	●	20	20	125	20.5	20					
ADKT-K-R/L-2525-5-T15	●	●	25	25	150	25.5	15					
ADKT-K-R/L-2525-5-T18	●	●	25	25	150	25.5	18					
ADKT-K-R/L-2525-5-T25	●	●	25	25	150	25.5	25					
ADKT-K-R/L-3232-5-T15	●	●	32	32	170	32.5	15					
ADKT-K-R/L-3232-5-T25	●	●	32	32	170	32.5	25					
ADKT-K-R/L-2525-6-T15	●	●	25	25	150	25.6	15					
ADKT-K-R/L-2525-6-T25	●	●	25	25	150	25.6	25					
ADKT-K-R/L-3232-6-T25	●	●	32	32	170	32.6	25					
ADKT-K-R/L-3232-8-T32	●	●	32	32	170	32.8	32					

R: Sağ / Right / Rechts L: Sol / Left / Links

● Stokta / In Stock / Auf Lager ○ Stokta Yok / Non Stock Item / Kein Lagerartikel, Lieferzeit auf Anfrage

KRRLY Ucuna Uygundur. / Compatible with KRRLY Insert. / Kompatibel mit KRRLY Wendeplatten.

Sipariş Örneği/Ordering Example/Bestellbeispiel

1 ad./pcs./stück ADKT-K-R-1212-1.5-T15

KRLY Ucuna Uygun. / Compatible with KRLY Insert. / Kompatibel mit KRLY Wendeplatten.

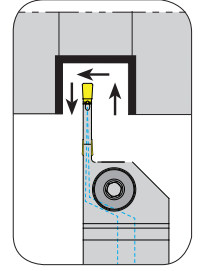
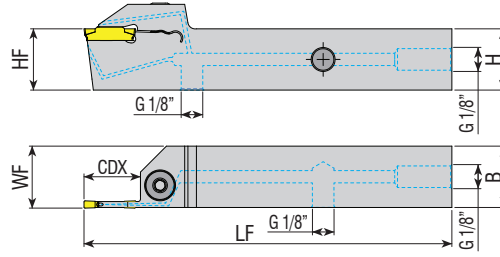

Takım Kodu Ordering Code Bestell-Bezeichnung	Stok Stock Lager		Takım Ölçüleri (mm) Dimension (mm) Abmessung (mm)				Kesici Uç Insert Wendeschneidplatte	Yedek Parçaları / Spare Parts / Ersatzteile			
	R	L	HF=H	B	LF	WF		CDX	Sıkma Vidası Screw Klemmschraube	Pul Stamp Ring	Anahtar Allen Key Innensechskantschlüssel
new ADKT-K-R/L-1616-2-T10-H	●	○	16	16	125	16.2	10	MGM. -2	AKV-02-M6x22	ABPL-01	AAL-03-3
new ADKT-K-R/L-1616-3-T15-H	●	○	16	16	125	16.3	15	MGM. -3	2004-M8x1x20	-	AAL-05-4
new ADKT-K-R/L-2020-3-R22-H	○	●	20	20	125	20.3	22				
ADKT-K-R/L-2020-3-T20-H	●	●	20	20	125	20.4	20	MGM. -4			
ADKT-K-R/L-2525-3-T22-H	●	●	25	25	150	25.4	22				
ADKT-K-R/L-2020-4-T20-H	●	●	20	20	125	20.4	20	MGM. -4			
ADKT-K-R/L-2525-4-T22-H	●	●	25	25	150	25.4	22				
ADKT-K-R/L-2525-5-T25-H	●	●	25	25	150	25.5	25	MGM. -4			

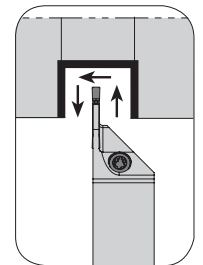
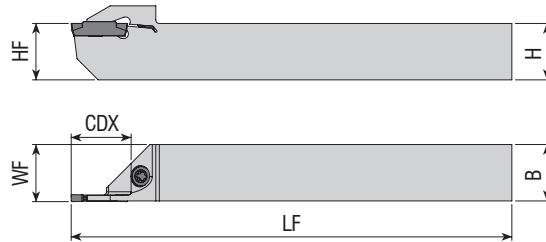

Takım Kodu Ordering Code Bestell-Bezeichnung	Stok Stock Lager		Takım Ölçüleri (mm) Dimension (mm) Abmessung (mm)				Kesici Uç Insert Wendeschneidplatte	Yedek Parçaları / Spare Parts / Ersatzteile			
	R	L	HF=H	B	LF	WF		CDX	Sıkma Vidası Screw Klemmschraube	Pul Stamp Ring	Tork Anahtar Torx Key Torx Innensechskantschlüssel
ADKT-K-R/L-1212-2-R12-K-S	●	●	12	12	125	12.20	12	MGM. -2	4015-M4x11	-	80-T15
ADKT-K-R/L-1616-2-R16-K-S	●	●	16	16	125	16.20	16				
ADKT-K-R/L-1212-3-R12-K-S	●	●	12	12	125	12.30	12	MGM. -3			
ADKT-K-R/L-1616-3-R16-K-S	●	●	16	16	125	16.30	16				

R: Sağ / Right / Rechts L: Sol / Left / Links
● Stokta / In Stock / Auf Lager ○ Stokta Yok / Non Stock Item / Kein Lagerartikel, Lieferzeit auf Anfrage
KRLY Ucuna Uygun. / Compatible with KRLY Insert. / Kompatibel mit KRLY Wendeplatten.

Sipariş Örneği/Ordering Example/Bestellbeispiel
1 ad./pcs./stück ADKT-K-R/L-1616-2-T10-H

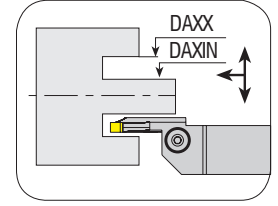
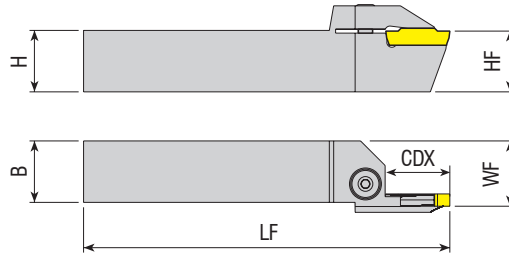

Takım Kodu Ordering Code Bestell-Bezeichnung	Stok Stock Lager		Takım Ölçüleri (mm) Dimension (mm) Abmessung (mm)							Kesici Uç Insert Wendeschneidplatte	Yedek Parçaları / Spare Parts / Ersatzteile		
	R	L	HF=H	B	LF	WF	CDX	DAXIN	DAXX	Sıkma Vidası Screw Klemmschraube	Pul Stamp Ring	Tork Anahtar Torx Key Torx Innensechskantschlüssel	
AAKT-K-R/L-2525-34-45-3-T17	●	●	25	25	150	26.5	17	34	45	MGM. - 3			
AAKT-K-R/L-2525-39-55-3-T17	●	●	25	25	150	26.5	17	39	55				
AAKT-K-R/L-2525-49-80-3-T17	●	●	25	25	150	26.5	17	49	80				
AAKT-K-R/L-2525-70-110-3-T17	●	●	25	25	150	26.5	17	70	110				
AAKT-K-R/L-2525-100-150-3-T17	●	●	25	25	150	26.5	17	100	150				
AAKT-K-R/L-2525-80-180-3-T32	●	●	25	25	150	26.5	32	80	180				
AAKT-K-R/L-2525-175-215-3-T22	●	●	25	25	150	26.5	22	175	215				
AAKT-K-R/L-2525-700-800-3-T17	●	●	25	25	150	26.5	17	700	800				
new AAKT-K-R/L-3232-140-450-3-T17	●	●	32	32	170	33.5	17	140	450	MGM. - 4	2004-M8x1x20	-	AAL-05-4
AAKT-K-R/L-2525-50-85-4-T22	●	●	25	25	150	26.5	22	50	85				
AAKT-K-R/L-2525-70-110-4-T22	●	●	25	25	150	26.5	22	70	110				
AAKT-K-R/L-2525-100-150-4-T22	●	●	25	25	150	26.5	22	100	150				
AAKT-K-R/L-2525-80-180-4-T32	●	●	25	25	150	26.5	32	80	180				
AAKT-K-R/L-2525-180-800-4-T32	●	●	25	25	150	26.5	32	180	800				
AAKT-K-R/L-2525-70-110-5-T25	●	●	25	25	150	26.5	25	70	110				
AAKT-K-R/L-2525-100-150-5-T25	●	●	25	25	150	26.5	25	100	150				
new AAKT-K-R/L-2525-100-200-5-T45	●	●	25	25	150	26.5	45	100	200	MGM. - 5			
AAKT-K-R/L-2525-80-180-5-T32	●	●	25	25	150	26.5	32	80	180				
AAKT-K-R/L-2525-140-200-5-T25	●	○	25	25	150	26.5	25	140	200				
AAKT-K-R/L-2525-180-800-5-T32	●	●	25	25	150	26.5	32	180	800				
AAKT-K-R/L-2525-180-800-5-T40	●	○	25	25	150	26.5	40	180	800				
AAKT-K-R/L-2525-60-100-6-T25	●	○	25	25	150	26.5	25	60	100				
AAKT-K-R/L-2525-60-100-6-T35	●	○	25	25	150	26.5	35	60	100				
AAKT-K-R/L-2525-100-200-6-T25	●	○	25	25	150	26.5	25	100	200				
AAKT-K-R/L-2525-100-200-6-T35	●	●	25	25	150	26.5	35	100	200	MGM. - 6			
AAKT-K-R/L-2525-100-200-6-T45	●	○	25	25	150	26.5	45	100	200				
AAKT-K-R/L-2525-140-300-6-T35	●	●	25	25	150	26.5	35	140	300				
AAKT-K-R/L-2525-180-360-6-T40	●	○	25	25	150	26.5	40	180	360				
new AAKT-K-R-3232-140-800-6-T25	○	○	32	32	170	33.5	25	140	800				
new AAKT-K-R-3232-180-800-6-T41	○	○	32	32	170	33.5	41	180	800				
new AAKT-K-R-3232-400-500-6-T25	●	○	32	32	170	33.5	25	400	500				
AAKT-K-R/L-2525-140-300-8-T35	●	○	25	25	150	26.5	35	140	300				MGM. - 8
AAKT-K-R/L-3232-140-350-8-T35	●	○	32	32	150	33.5	35	140	350				

R: Sağ / Right / Rechts L: Sol / Left / Links

● Stokta / In Stock / Auf Lager ○ Stokta Yok / Non Stock Item / Kein Lagerartikel, Lieferzeit auf Anfrage

KRRLY Ucuna Uygundur. / Compatible with KRRLY Insert. / Kompatibel mit KRRLY Wendeplatten.

Sipariş Örneği/Ordering Example/Bestellbeispiel

1 ad./pcs./stück AAKT-K-R-2525-34-45-3-T17

KRRLY Ucuna Uygundur. / Compatible with KRRLY Insert. / Kompatibel mit KRRLY Wendeplatten.

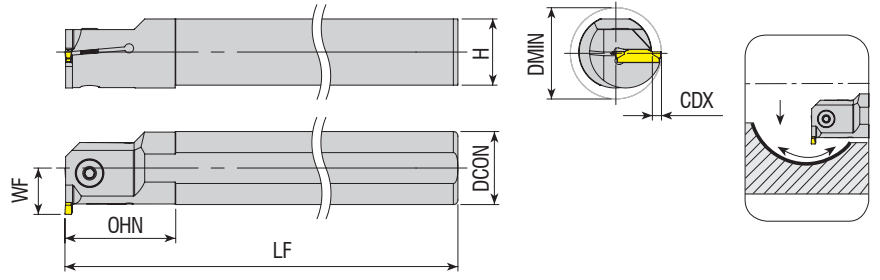

Takım Kodu Ordering Code Bestell-Bezeichnung	Stok Stock Lager		Takım Ölçüleri (mm) Dimension (mm) Abmessung (mm)							Kesici Uç Insert Wendeschneidplatte	Yedek Parçaları / Spare Parts / Ersatzteile	
	R	L	DCON	DMIN	LF	OHN	CDX	H	WF		Sıkma Vidası Screw Klemmschraube	Anahtar Allen Key Innensechskantschlüssel
AIKT-K-R/L-16-2-T4	●	●	16	21	150	28	4	14.8	12	MGM. - 2	2503-M4x10	AAL-03-3
AIKT-K-R/L-20-2-T4	●	●	20	25	170	30	4	18.3	14		2503-M4x12	
AIKT-K-R/L-25-2-T6	●	●	25	32	200	40	6	23	18.5		2504-M5x12	
new AIKT-K-R/L-16-3-T7	●	●	16	25	150	28	7	14.8	15	MGM. - 3	2503-M4x12	AAL-05-4
AIKT-K-R/L-20-3-T6	●	●	20	27	170	30	6	18.3	16		2504-M5x12	
AIKT-K-R/L-20-3-T7	●	●	20	25	170	38	7	18.3	13		2504-M5x16	
AIKT-K-R/L-25-3-T6	●	●	25	32	200	40	6	23	18.5		2004-M8x1x20	
AIKT-K-R/L-25-3-T10	●	●	25	32	200	48	10	23	17		2504-M5x12	
AIKT-K-R/L-32-3-T6	●	●	32	39	250	50	6	30	22		2504-M5x16	
AIKT-K-R/L-32-3-T12	●	●	32	39	250	53	12	30	22		2004-M8x1x20	
AIKT-K-R/L-40-3-T6	●	●	40	47	300	55	6	37.5	26		2504-M5x12	
AIKT-K-R/L-40-3-T12	●	○	40	48	300	63	12	37.5	27		2504-M5x16	
AIKT-K-R/L-20-4-T6	●	●	20	27	170	30	6	18.3	16		MGM. - 4	
AIKT-K-R/L-20-4-T7	●	○	20	25	170	38	7	18.3	13	2504-M5x16		
AIKT-K-R/L-25-4-T6	●	●	25	32	200	40	6	23	18.5	2004-M8x1x20		
AIKT-K-R/L-25-4-T10	●	●	25	32	200	49	10	23	17	2504-M5x12		
AIKT-K-R/L-32-4-T6	●	●	32	39	250	50	6	30	22	2504-M5x16		
AIKT-K-R/L-32-4-T12	●	●	32	39	250	53	12	30	22	2004-M8x1x20		
AIKT-K-R/L-40-4-T6	●	●	40	47	300	55	6	37.5	26	2504-M5x12		
AIKT-K-R/L-40-4-T12	●	●	40	48	300	63	12	37.5	27	2504-M5x16		
AIKT-K-R/L-25-5-T7	●	●	25	33	200	40	7	23	19.5	MGM. - 5	2004-M8x1x20	
AIKT-K-R/L-32-5-T7	●	●	32	40	250	50	7	30	23			
AIKT-K-R/L-40-5-T7	●	●	40	48	300	55	7	37.5	27			
AIKT-K-R/L-40-5-T12	●	○	40	48	300	63	12	37.5	27			

R: Sağ / Right / Rechts L: Sol / Left / Links

● Stokta / In Stock / Auf Lager ○ Stokta Yok / Non Stock Item / Kein Lagerartikel, Lieferzeit auf Anfrage

KRRLY Ucuna Uygundur. / Compatible with KRRLY Insert. / Kompatibel mit KRRLY Wendeplatten.

Sipariş Örneği/Ordering Example/Bestellbeispiel

1 ad./pcs./stück AIKT-K-R-16-2-T4

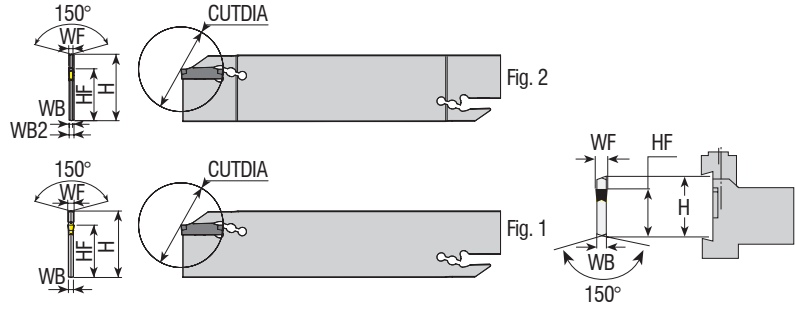

Takım Kodu Ordering Code Bestell-Bezeichnung	Stok Stock Lager	Takım Ölçüleri (mm) Dimension (mm) Abmessung (mm)								Kesici Uç Insert Wendeschneidplatte	Yedek Parçaları / Spare Parts Ersatzteile	
		H	WF	WB2	WB	I	HF	CUTDIA	Fig.		Anahtar Allen Key Innensechskantschlüssel	
AKL-K-32-2	●	32	2	2.40	1.60	150	25	32	2	MGM.-2	ALA-02	
AKL-K-32-3	●	32	3	-	2.40	150	25	42	1	MGM.-3		
AKL-K-32-4	●	32	4	-	3.20	150	25	42	1	MGM.-4		

Blok bilgileri için sayfa 155'ye gidin. / For block information, go to page 155. / Informationen zu den spannblock finden Sie auf Seite 155.

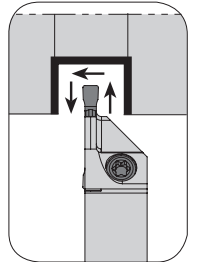
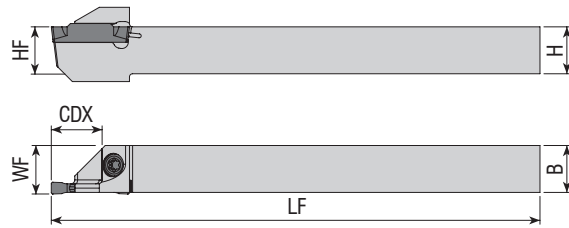

Takım Kodu Ordering Code Bestell-Bezeichnung	Stok Stock Lager		Takım Ölçüleri (mm) Dimension (mm) Abmessung (mm)					Kesici Uç Insert Wendeschneidplatte	Yedek Parçaları / Spare Parts / Ersatzteile			
	R	L	HF=H	B	LF	WF	CDX		Sıkma Vidası Screw Klemmschraube	Pul Stamp Ring	Tork Anahtar Torx Key Torx Innensechskantschlüssel	
ADKT-KG-R/L-1010-2-R10-K-S	●	○	10	10	125	10.2	10	KG. - 2	AKV-02-M6x22	ABPL-01	AAL-03-3	
ADKT-KG-R/L-1212-2-R12-K-S	●	●	12	12	125	12.2	12		4015-M4x11	-	80-T15	
ADKT-KG-R/L-1616-2-R16-K-S	●	●	16	16	125	16.2	16					
ADKT-KG-R/L-1212-3-R12-K-S	●	●	12	12	125	12.3	12	KG. - 3	-	-		
ADKT-KG-R/L-1616-3-R16-K-S	●	●	16	16	125	16.3	16					

R: Sağ / Right / Rechts L: Sol / Left / Links

● Stokta / In Stock / Auf Lager ○ Stokta Yok / Non Stock Item / Kein Lagerartikel, Lieferzeit auf Anfrage

KRLY Ucuna Uygundur. / Compatible with KRLY Insert. / Kompatibel mit KRLY Wendeplatten.

Sipariş Örneği/Ordering Example/Bestellbeispiel

1 ad./pcs./stück AKL-K-32-2

KRLY Ucuna Uygundur. / Compatible with KRLY Insert. / Kompatibel mit KRLY Wendeplatten.

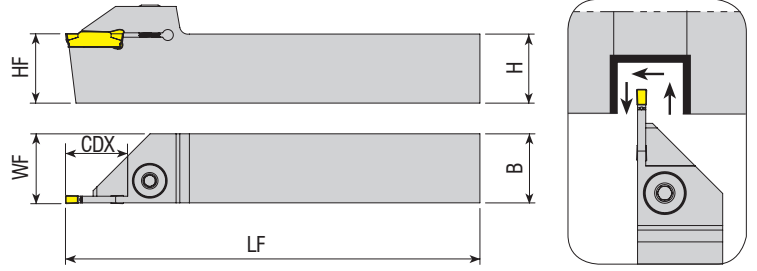
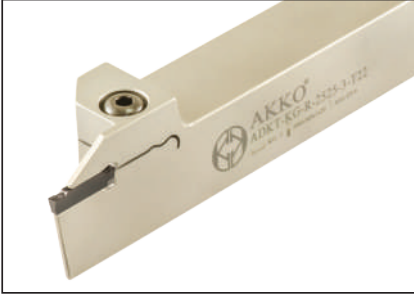

Takım Kodu Ordering Code Bestell-Bezeichnung	Stok Stock Lager		Takım Ölçüleri (mm) Dimension (mm) Abmessung (mm)				Kesici Uç Insert Wendeschneidplatte	Yedek Parçaları / Spare Parts / Ersatzteile			
	R	L	HF=H	B	LF	WF		CDX	Sıkma Vidası Screw Klemmschraube	Pul Stamp Ring	Anahtar Allen Key Innensechskantschlüssel
ADKT-KG-R/L-2020-2-T15	●	●	20	20	125	20.2	15	KG.. - 2	AKV-02-M6x22	ABPL-01	AAL-03-3
ADKT-KG-R/L-2525-2-T8	●	●	25	25	150	25.2	8				
ADKT-KG-R/L-2525-2-T15	●	○	25	25	150	25.2	15				
ADKT-KG-R/L-2525-2-T17	●	○	25	25	150	25.2	17	KG.. - 3	2004-M8x1x20	-	AAL-05-4
ADKT-KG-R/L-1616-3-T20	●	●	16	16	125	16.3	20				
ADKT-KG-R/L-2020-3-T20	●	●	20	20	125	20.3	20				
ADKT-KG-R/L-2525-3-T10	●	●	25	25	150	25.3	10				
ADKT-KG-R/L-2525-3-T13	●	●	25	25	150	25.3	13				
ADKT-KG-R/L-2525-3-T22	●	●	25	25	150	25.3	22				
ADKT-KG-R/L-2020-4-T20	●	●	20	20	125	20.4	20	KG.. - 4	2004-M8x1x20	-	AAL-05-4
ADKT-KG-R/L-2525-4-T10	●	●	25	25	150	25.4	10				
ADKT-KG-R/L-2525-4-T16	●	○	25	25	150	25.4	16				
ADKT-KG-R/L-2525-4-T22	●	○	25	25	150	25.4	22				
ADKT-KG-R/L-2525-5-T12	●	●	25	25	150	25.5	12	KG.. - 5	2004-M8x1x20	-	AAL-05-4
ADKT-KG-R/L-2525-5-T15	●	●	25	25	150	25.5	15				
ADKT-KG-R/L-2525-5-T25	●	○	25	25	150	25.5	25				
ADKT-KG-R/L-2525-6-T25	○	○	25	25	150	25.6	25	KG.. - 6	2004-M8x1x20	-	AAL-05-4

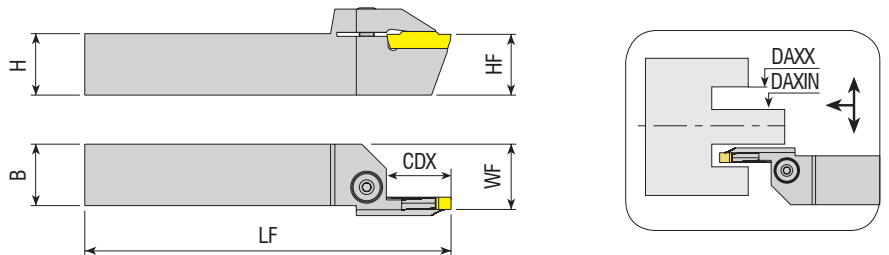

Takım Kodu Ordering Code Bestell-Bezeichnung	Stok Stock Lager		Takım Ölçüleri (mm) Dimension (mm) Abmessung (mm)							Kesici Uç Insert Wendeschneidplatte	Yedek Parçaları / Spare Parts / Ersatzteile			
	R	L	HF=H	B	LF	WF	CDX	DAXIN	DAXX		Sıkma Vidası Screw Klemmschraube	Pul Stamp Ring	Anahtar Allen Key Innensechskantschlüssel	
AAKT-KG-R/L-2525-44-70-4-T22	○	○	25	25	150	26.5	22	44	70	KG.. - 4	2004-M8x1x20	-	AAL-05-4	
AAKT-KG-R/L-2525-60-120-4-T22	○	○	25	25	150	26.5	22	60	120					
AAKT-KG-R/L-2525-112-200-4-T22	○	○	25	25	150	26.5	22	112	200					

R: Sağ / Right / Rechts L: Sol / Left / Links
● Stokta / In Stock / Auf Lager ○ Stokta Yok / Non Stock Item / Kein Lagerartikel, Lieferzeit auf Anfrage
KRLY Ucuna Uygundur. / Compatible with KRLY Insert. / Kompatibel mit KRLY Wendeplatten.

Sipariş Örneği/Ordering Example/Bestellbeispiel
1 ad./pcs./stück ADKT-KG-R-2020-2-T15

KRLY Ucuna Uygundur. / Compatible with KRLY Insert. / Kompatibel mit KRLY Wendeplatten.

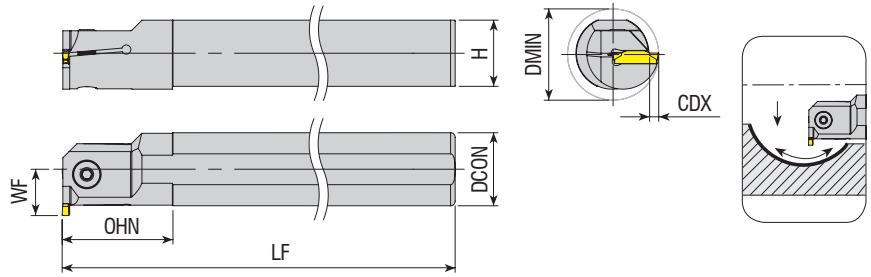

Takım Kodu Ordering Code Bestell-Bezeichnung	Stok Stock Lager		Takım Ölçüleri (mm) Dimension (mm) Abmessung (mm)							Kesici Uç Insert Wendeschneidplatte	Yedek Parçaları / Spare Parts / Ersatzteile	
	R	L	DCON	DMIN	LF	OHN	CDX	H	WF	Sıkma Vidası Screw Klemmschraube	Anahtar Allen Key Innensechskantschlüssel	
AIKT-KG-R/L-25-2-T7	●	●	25	33	200	40	7	23	19.5	KG.. - 2	2504-M5x12	AAL-05-4
AIKT-KG-R/L-20-3-T6.5-H	●	○	20	27.5	170	30	6.5	18.3	16.5	KG.. - 3	2504-M5x16	
AIKT-KG-R/L-25-3-T7	○	○	25	33	200	40	7	23	19.5		2004-M8x1x20	
AIKT-KG-R/L-40-3-T8	●	○	40	50	300	55	8	37.5	28	2504-M5x16		
AIKT-KG-R/L-25-4-T8	●	●	25	34	200	40	8	23	20.5	KG.. - 4		

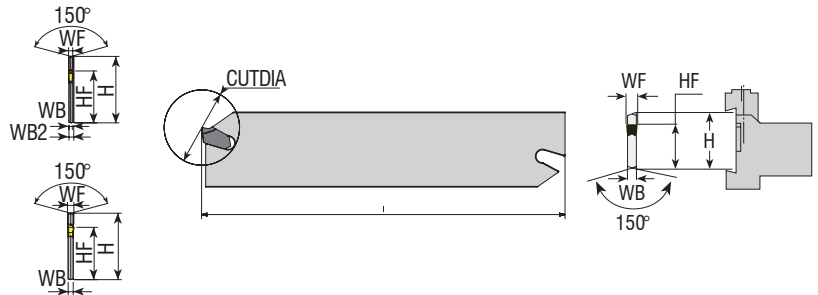

Takım Kodu Ordering Code Bestell-Bezeichnung	Stok Stock Lager	Takım Ölçüleri (mm) Dimension (mm) Abmessung (mm)								Kesici Uç Insert Wendeschneidplatte	Yedek Parçaları / Spare Parts / Ersatzteile	
		H	WF	WB2	WB	I	HF	CUTDIA	Fig.	Sıkma Vidası Screw Klemmschraube	Anahtar Allen Key Innensechskantschlüssel	
AKL-SP-26-2	●	26	2	-	1.60	110	21	-	1	SP200N	ALA-03	
AKL-SP-26-3	●	26	3	-	2.40	110	21	-	1	SP300N		
AKL-SP-32-3	●	32	3	-	2.40	150	25	-	1	SP400N		
AKL-SP-32-4	●	32	4	-	3.20	150	25	-	1			

R: Sağ / Right / Rechts L: Sol / Left / Links

● Stokta / In Stock / Auf Lager ○ Stokta Yok / Non Stock Item / Kein Lagerartikel, Lieferzeit auf Anfrage

Block bilgileri için sayfa 155'ye gidin. / For block information, go to page 155. / Informationen zu den spannblock finden Sie auf Seite 155.

KRLY Ucuna Uygundur. / Compatible with KRLY Insert. / Kompatibel mit KRLY Wendeplatten.

Sipariş Örneği/Ordering Example/Bestellbeispiel

1 ad./pcs./stück AIKT-KG-R/L-25-2-T7

LMN Ucuna Uygundur. / Compatible with LMN Insert. / Kompatibel mit LMN Wendeplatten.

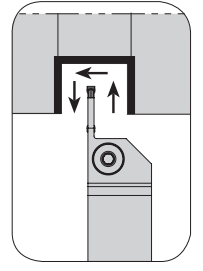
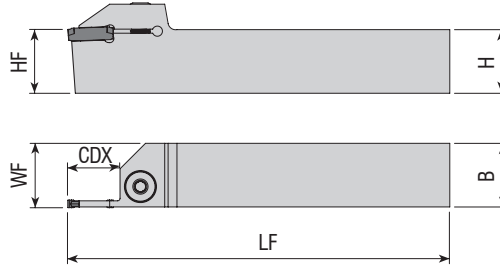

Takım Kodu Ordering Code Bestell-Bezeichnung	Stok Stock Lager		Takım Ölçüleri (mm) Dimension (mm) Abmessung (mm)					Kesici Uç Insert Wendeschneidplatte	Yedek Parçaları / Spare Parts / Ersatzteile			
	R	L	HF=H	B	LF	WF	CDX		Sıkma Vidası Screw Klemmschraube	Pul Stamp Ring	Anahtar Allen Key Innensechskantschlüssel	
ADKT-LGC-R/L-1616-2-D40	●	●	16	16	125	16.2	20	GCTX - 2	AKV-02-M6x22	ABPL-01	AAL-03-3	
ADKT-LGC-R/L-2020-2-D40	●	●	20	20	125	20.2	20					
ADKT-LGC-R/L-2525-2-D40	●	●	25	25	150	25.2	20					
ADKT-LGC-R/L-1616-3-T20	●	●	16	16	125	16.3	20	GCTX - 3	2004-M8x1x20	-	AAL-05-4	
ADKT-LGC-R/L-2020-3-T20	●	●	20	20	125	20.3	20					
ADKT-LGC-R/L-2525-3-T20	●	●	25	25	150	25.3	20					

LMN Ucuna Uygundur. / Compatible with LMN Insert. / Kompatibel mit LMN Wendeplatten.

MTSBH Ucuna Uygundur. / Compatible with MTSBH Insert. / Kompatibel mit MTSBH Wendeplatten.

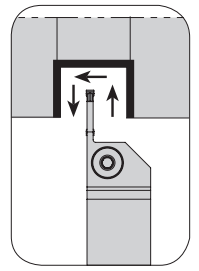
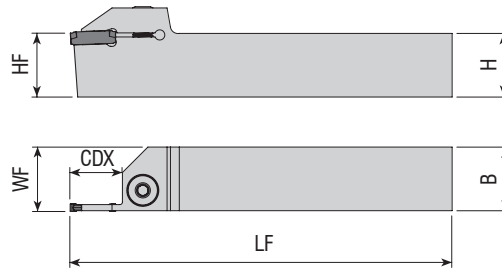

Takım Kodu Ordering Code Bestell-Bezeichnung	Stok Stock Lager		Takım Ölçüleri (mm) Dimension (mm) Abmessung (mm)					Kesici Uç Insert Wendeschneidplatte	Yedek Parçaları / Spare Parts / Ersatzteile			
	R	L	HF=H	B	LF	WF	CDX		Sıkma Vidası Screw Klemmschraube	Pul Stamp Ring	Anahtar Allen Key Innensechskantschlüssel	
ADKT-GY2-R/L-2525-2-R20	●	○	25	25	150	25.2	20	GY2M-0200	AKV-02-M6X22	ABPL-01	AAL-03-3	
ADKT-GY2-R/L-2525-2.5-R6	●	○	25	25	150	25.25	6					GY2M-0250
ADKT-GY2-R/L-2525-3-R20	●	○	25	25	150	25.3	20	GY2M-0300	2004-M8x1x20	-	AAL-05-4	
ADKT-GY2-R/L-2525-4-T25	●	○	25	25	150	25.4	25					GY2M-0400
ADKT-GY2-R/L-2525-5-T25	●	○	25	25	150	25.5	25					GY2M-0500

R: Sağ / Right / Rechts L: Sol / Left / Links

● Stokta / In Stock / Auf Lager ○ Stokta Yok / Non Stock Item / Kein Lagerartikel, Lieferzeit auf Anfrage

MTSBH Ucuna Uygundur. / Compatible with MTSBH Insert. / Kompatibel mit MTSBH Wendeplatten.

Sipariş Örneği/Ordering Example/Bestellbeispiel

1 ad./pcs./stück ADKT-LGC-R-1616-2-D40



MTSBH Ucuna Uygundur. / Compatible with MTSBH Insert. / Kompatibel mit MTSBH Wendeplatten.

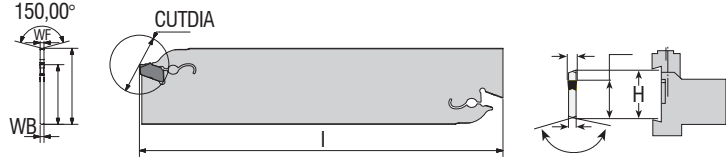

Takım Kodu Ordering Code Bestell-Bezeichnung	Stok Stock Lager		Takım Ölçüleri (mm) Dimension (mm) Abmessung (mm)							Kesici Uç Insert Wendeschneidplatte	Yedek Parçaları / Spare Parts Ersatzteile	
	R	L	H	WF	WB2	WB	I	HF	CUTDIA		Fig.	Anahtar Allen Key Innensechskantschlüssel
AKL-GW1-32-2	●		32	2	1.6	-	150	25	60	1	GW1M0200D020N	ALA-02
AKL-GW1-32-3	●		32	3	2.4	-	150	25	60	1	GW1M0300F030N	
AKL-GW1-32-4	●		32	4	3.35	-	150	25	60	1	GW1M0400H030N	

Blok bilgileri için sayfa 155'ye gidin. / For block information, go to page 155. / Informationen zu den spannblock finden Sie auf Seite 155.

MTSBH Ucuna Uygundur. / Compatible with MTSBH Insert. / Kompatibel mit MTSBH Wendeplatten.

NTK Ucuna Uygundur. / Compatible with NTK Insert. / Kompatibel mit NTK Wendeplatten.

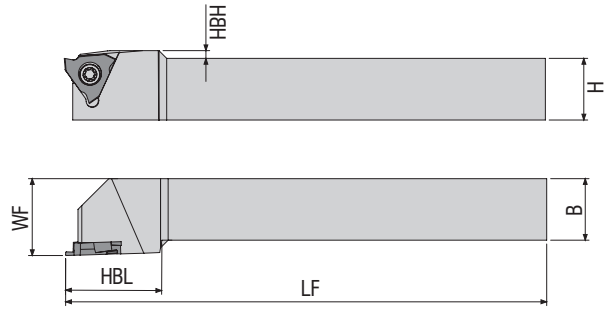
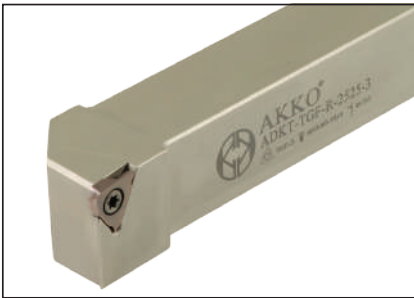

Takım Kodu Ordering Code Bestell-Bezeichnung	Stok Stock Lager		Takım Ölçüleri (mm) Dimension (mm) Abmessung (mm)				Kesici Uç Insert Wendeschneidplatte	Yedek Parçaları / Spare Parts / Ersatzteile			
	R	L	HF=H	B	LF	WF		Sıkma Vidası Screw Klemmschraube	Pul Stamp Ring	Tork Anahtar Torx Key Torx Innensechskantschlüssel	
ADKT-TGF-R/L-1616-3	●	○	16	16	125	20	QC16L150	4015-M3.5X10	-	80-T15	
ADKT-TGF-R/L-2020-3	●	○	20	20	125	25					
ADKT-TGF-R/L-2525-3	●	○	25	25	150	32					

R: Sağ / Right / Rechts L: Sol / Left / Links

● Stokta / In Stock / Auf Lager ○ Stokta Yok / Non Stock Item / Kein Lagerartikel, Lieferzeit auf Anfrage

NTK Ucuna Uygundur. / Compatible with NTK Insert. / Kompatibel mit NTK Wendeplatten.

Sipariş Örneği/Ordering Example/Bestellbeispiel

1 ad./pcs./stück AKL-GW1-32-2

PLBT Ucuna Uygun. / Compatible with PLBT Insert. / Kompatibel mit PLBT Wendeplatten.

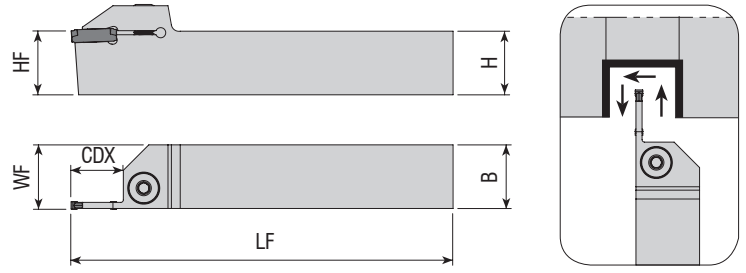

Takım Kodu Ordering Code Bestell-Bezeichnung	Stok Stock Lager		Takım Ölçüleri (mm) Dimension (mm) Abmessung (mm)				Kesici Uç Insert Wendeschneidplatte	Yedek Parçaları / Spare Parts / Ersatzteile			
	R	L	HF=H	B	LF	WF		CDX	Sıkma Vidası Screw Klemmschraube	Pul Stamp Ring	Anahtar Allen Key Innensechskantschlüssel
ADKT-GP-R/L-2020-2-T15	●	●	20	20	125	20.2	15	GP - 2	AKV-02-M6x22	ABPL-01	AAL-03-3
ADKT-GP-R/L-2525-2-T15	●	●	25	25	150	25.2	15				
ADKT-GP-R/L-2020-3-T20	●	●	20	20	125	20.3	20	GP - 3	2004-M8x1x20	-	AAL-05-4
ADKT-GP-R/L-2525-3-T22	●	●	25	25	150	25.3	22				
ADKT-GP-R/L-2525-4-T22	●	●	25	25	150	25.4	22	GP - 4	-	-	-
ADKT-GP-R/L-2525-5-T25	●	●	25	25	150	25.5	25				

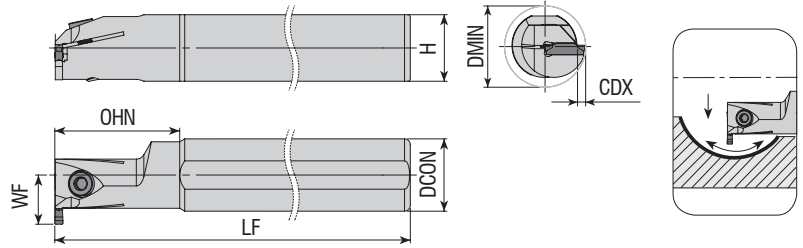

Takım Kodu Ordering Code Bestell-Bezeichnung	Stok Stock Lager		Takım Ölçüleri (mm) Dimension (mm) Abmessung (mm)						Kesici Uç Insert Wendeschneidplatte	Yedek Parçaları / Spare Parts / Ersatzteile		
	R	L	DCON	DMIN	LF	OHN	CDX	H		WF	Sıkma Vidası Screw Klemmschraube	Anahtar Allen Key Innensechskantschlüssel
AIKT-GP-R/L-20-2-T4	●	○	20	25	170	30	4	18.3	14.5	GP - 2	2503-M4x12	AAL-03-3
AIKT-GP-R/L-25-2-T6	●	○	25	32	200	40	6	23	18.5			
AIKT-GP-R/L-20-3-T6	●	○	20	27	170	30	6	18.3	16	GP - 3	2504-M5X16	AAL-05-4
AIKT-GP-R/L-25-3-T6	●	○	25	32	200	40	6	23	18.5			
AIKT-GP-R/L-32-3-T6	●	○	32	39	250	50	6	30	22	GP - 4	2004-M8x1x20	-
AIKT-GP-R/L-20-4-T6	●	○	20	27	170	30	6	18.3	16			
AIKT-GP-R/L-25-4-T6	●	○	25	32	200	40	6	23	18.5	-	-	-
AIKT-GP-R/L-32-4-T6	●	○	32	39	250	50	6	30	22			

R: Sağ / Right / Rechts L: Sol / Left / Links

● Stokta / In Stock / Auf Lager ○ Stokta Yok / Non Stock Item / Kein Lagerartikel, Lieferzeit auf Anfrage

PLBT Ucuna Uygun. / Compatible with PLBT Insert. / Kompatibel mit PLBT Wendeplatten.

Sipariş Örneği/Ordering Example/Bestellbeispiel
1 ad./pcs./stück ADKT-GP-R-2020-2-T15

SC Ucuna Uygundur. / Compatible with SC Insert. / Kompatibel mit SC Wendeplatten.

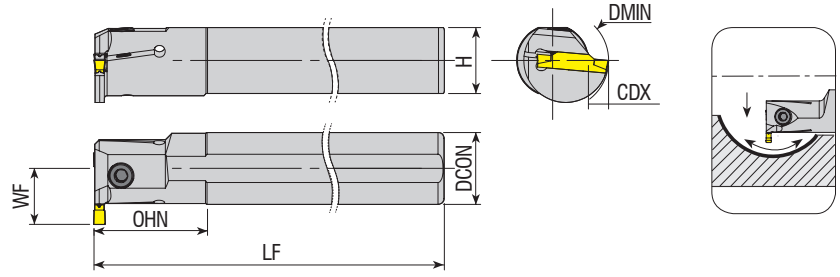

Takım Kodu Ordering Code Bestell-Bezeichnung	Stok Stock Lager		Takım Ölçüleri (mm) Dimension (mm) Abmessung (mm)							Kesici Uç Insert Wendeschneidplatte	Yedek Parçaları / Spare Parts / Ersatzteile		
	R	L	DCON	DMIN	LF	OHN	CDX	H	WF		Sıkma Vidası Screw Klemmschraube	Anahtar Allen Key Innensechskantschlüssel	
AIKT-LC13-R-16-3-T4	●	○	16	20	150	28	4	14.8	12	LC.. 130404-0300	2503-M4x10	AAL-03-3	
AIKT-LC13-R-16-4-T6	●	○	16	22	150	28	6	14.8	14				LC.. 130404-0400

SC Ucuna Uygundur. / Compatible with SC Insert. / Kompatibel mit SC Wendeplatten.

SMTM Ucuna Uygundur. / Compatible with SMTM Insert. / Kompatibel mit SMTM Wendeplatten.

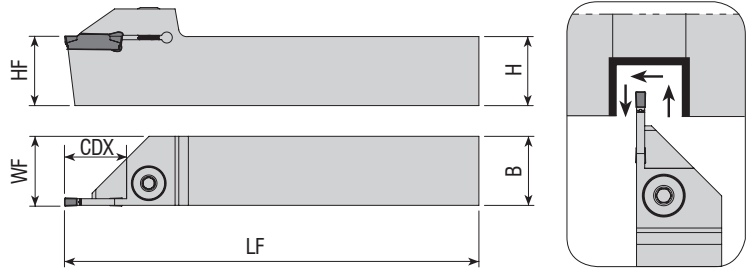

Takım Kodu Ordering Code Bestell-Bezeichnung	Stok Stock Lager		Takım Ölçüleri (mm) Dimension (mm) Abmessung (mm)					Kesici Uç Insert Wendeschneidplatte	Yedek Parçaları / Spare Parts / Ersatzteile			
	R	L	HF=H	B	LF	WF	CDX		Sıkma Vidası Screw Klemmschraube	Pul Stamp Ring	Anahtar Allen Key Innensechskantschlüssel	
ADKT-SGC-R/L-1212-2-R15	●	●	12	12	100	16.2	15	GCM N20	AKV-02-M6x22	ABPL-01	AAL-03-3	
ADKT-SGC-R/L-1616-2-R15	●	●	16	16	125	16.2	15					
ADKT-SGC-R/L-2020-2-R20	●	●	20	20	125	20.2	20					
ADKT-SGC-R/L-2525-2-R20	●	●	25	25	150	25.2	20	GCM N30	2004-M8x1x20	-	AAL-05-4	
ADKT-SGC-R/L-1212-3-R15	●	●	12	12	100	16.3	15					
ADKT-SGC-R/L-1616-3-T12	●	○	16	16	125	16.3	12					
ADKT-SGC-R/L-1616-3-R15	●	●	16	16	125	16.3	15	GCM N40				
ADKT-SGC-R/L-2020-3-R22	●	●	20	20	125	20.3	22					
ADKT-SGC-R/L-2525-3-T10	○	●	25	25	150	25.30	10					
ADKT-SGC-R/L-2525-3-R15	●	○	25	25	150	25.3	15	GCM N40				
ADKT-SGC-R/L-2525-3-R22	●	●	25	25	150	25.3	22					
ADKT-SGC-R/L-2525-4-T10	○	●	25	25	150	25.40	10					
ADKT-SGC-R/L-2525-4-T15	○	●	25	25	150	25.40	15	GCM N40				
ADKT-SGC-R/L-2525-4-T20	○	●	25	25	150	25.40	20					
ADKT-SGC-R/L-2525-4-R25	●	○	25	25	150	25.4	25					

R: Sağ / Right / Rechts L: Sol / Left / Links

● Stokta / In Stock / Auf Lager ○ Stokta Yok / Non Stock Item / Kein Lagerartikel, Lieferzeit auf Anfrage

SMTM Ucuna Uygundur. / Compatible with SMTM Insert. / Kompatibel mit SMTM Wendeplatten.

Sipariş Örneği/Ordering Example/Bestellbeispiel

1 ad./pcs./stück AIKT-LC13-R-16-3-T4

SMTM Ucuna Uygun. / Compatible with SMTM Insert. / Kompatibel mit SMTM Wendeplatten.

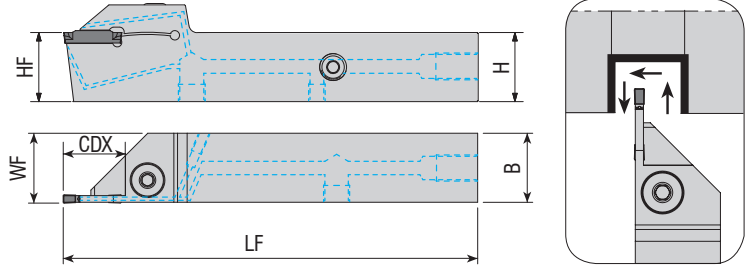

Takım Kodu
Ordering Code
Bestell-Bezeichnung

Stok
Stock
Lager

R

L

HF=H

B

LF

WF

CDX

Takım Ölçüleri (mm)
Dimension (mm)
Abmessung (mm)

Kesici Uç
Insert
Wendeschneidplatte

Yedek Parçaları / Spare Parts / Ersatzteile

Sıkma Vidası
Screw
Klemmschraube

Pul
Stamp
Ring

Anahtar
Allen Key
Innensechskantschlüssel

ADKT-SGC-R/L-2525-3-R25-H

○

●

25

25

150

25.3

25

GCM N30

2004-M8x1x20

-

AAL-05-4

R: Sağ / Right / Rechts L: Sol / Left / Links

● Stokta / In Stock / Auf Lager ○ Stokta Yok / Non Stock Item / Kein Lagerartikel, Lieferzeit auf Anfrage

SMTM Ucuna Uygun. / Compatible with SMTM Insert. / Kompatibel mit SMTM Wendeplatten.

Sipariş Örneği/Ordering Example/Bestellbeispiel

1 ad./pcs./stück ADKT-SGC-R-2525-3-R25-H



SMTM Ucuna Uygundur. / Compatible with SMTM Insert. / Kompatibel mit SMTM Wendeplatten.

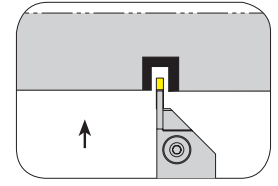
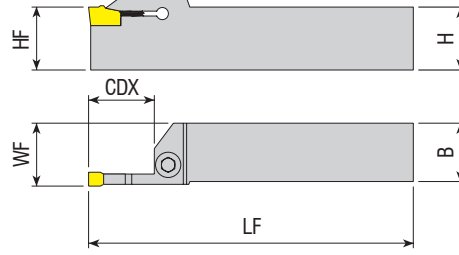

Takım Kodu Ordering Code Bestell-Bezeichnung	Stok Stock Lager		Takım Ölçüleri (mm) Dimension (mm) Abmessung (mm)					Kesici Uç Insert Wendeschneidplatte	Yedek Parçaları / Spare Parts / Ersatzteile		
	R	L	HF=H	B	LF	WF	CDX		Sıkma Vidası Screw Klemmschraube	Pul Stamp Ring	Anahtar Allen Key Innensechskantschlüssel
ADKT-SWC-R/L-2020-2-T25	●	○	20	20	125	20.3	25	WCF - 2	AKV-02-M6x22	ABPL-01	AAL-03-3
ADKT-SWC-R/L-2020-3-T25	●	○	20	20	125	20.4	25	WCF - 3	2004-M8x1x20	-	AAL-05-4

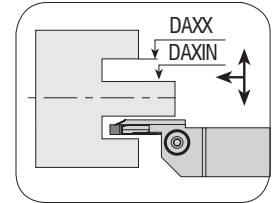
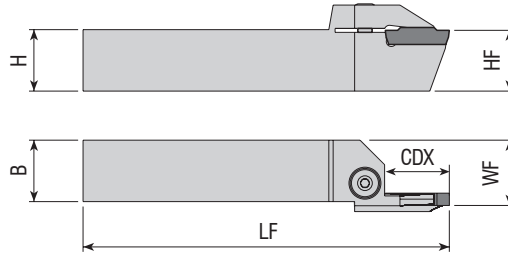

Takım Kodu Ordering Code Bestell-Bezeichnung	Stok Stock Lager		Takım Ölçüleri (mm) Dimension (mm) Abmessung (mm)							Kesici Uç Insert Wendeschneidplatte	Yedek Parçaları / Spare Parts / Ersatzteile		
	R	L	HF=H	B	LF	WF	CDX	DAXIN	DAXX		Sıkma Vidası Screw Klemmschraube	Pul Stamp Ring	Anahtar Allen Key Innensechskantschlüssel
AAKT-SGC-R/L-2020-22-53-3-T13	○	●	20	20	125	21.5	13	22	53	GCM N3002	2004-M8X1X20	-	AAL-05-4
AAKT-SGC-R/L-2525-80-100-3-T8	●	○	25	25	150	26.5	8	80	100				
AAKT-SGC-R/L-2525-40-65-4-T12	●	○	25	25	150	26.5	12	40	65	GCM N4020	2004-M8X1X20	-	AAL-05-4
AAKT-SGC-R/L-2525-80-140-4-T8	●	○	25	25	150	26.5	8	80	140				

R: Sağ / Right / Rechts L: Sol / Left / Links

● Stokta / In Stock / Auf Lager ○ Stokta Yok / Non Stock Item / Kein Lagerartikel, Lieferzeit auf Anfrage

SMTM Ucuna Uygundur. / Compatible with SMTM Insert. / Kompatibel mit SMTM Wendeplatten.

Sipariş Örneği/Ordering Example/Bestellbeispiel

1 ad./pcs./stück ADKT-SWC-R-2020-2-T25

SMTM Ucuna Uygun. / Compatible with SMTM Insert. / Kompatibel mit SMTM Wendeplatten.

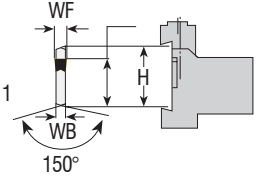
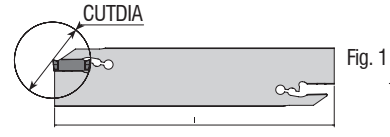
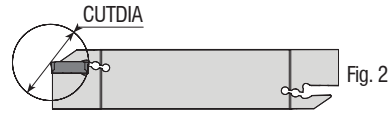
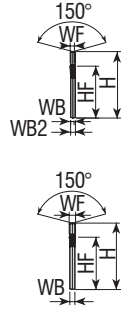

Takım Kodu Ordering Code Bestell-Bezeichnung	Stok Stock Lager	Takım Ölçüleri (mm) Dimension (mm) Abmessung (mm)								Kesici Uç Insert Wendeschneidplatte	Yedek Parçaları / Spare Parts Ersatzteile	
		H	WF	WB2	WB	I	HF	CUTDIA	Fig.		Anahtar Allen Key Innensechskantschlüssel	
AKL-SGC-26-3	●	26	3	2.40	-	110	21.4	39	2	GCM N30	ALA-02	
AKL-SGC-32-3	●	32	3	2.40	-	150	25	39	1			

Blok bilgileri için sayfa 155'ye gidin. / For block information, go to page 155. / Informationen zu den spannblock finden Sie auf Seite 155.

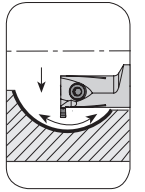
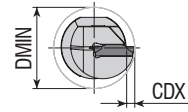
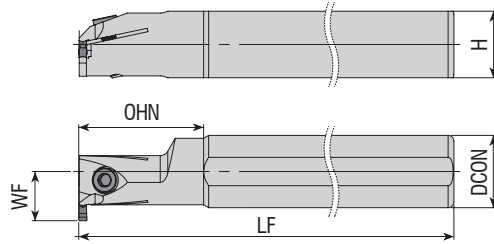

Takım Kodu Ordering Code Bestell-Bezeichnung	Stok Stock Lager		Takım Ölçüleri (mm) Dimension (mm) Abmessung (mm)							Kesici Uç Insert Wendeschneidplatte	Yedek Parçaları / Spare Parts / Ersatzteile	
	R	L	DCON	DMIN	LF	OHN	CDX	H	WF		Sıkma Vidası Screw Klemmschraube	Anahtar Allen Key Innensechskantschlüssel
AIKT-SGC-R/L-25-3-T6	●	○	25	32	200	40	6	23	18.5	GCM N30	2504-M5x16	AAL-05-4
AIKT-SGC-R/L-32-3-T6	●	○	32	39	250	50	6	30	22			
new AIKT-SGC-R/L-32-3-T12	●	●	32	45	250	50	12	30	28			
AIKT-SGC-R/L-40-3-T6	●	○	40	47	300	55	6	37.5	26			
new AIKT-SGC-R/L-40-3-T12	●	●	40	53	300	55	12	37.5	12	GCM N40	2504-M5x16	AAL-05-4
new AIKT-SGC-R/L-25-4-T6	●	●	25	32	200	40	6	23	18.5			
new AIKT-SGC-R/L-25-4-T12	●	●	25	38	200	40	12	23	24.5			
new AIKT-SGC-R/L-32-4-T6	●	●	32	39	250	50	6	30	22			
new AIKT-SGC-R/L-32-4-T12	●	●	32	45	250	50	12	30	28			
new AIKT-SGC-R/L-40-4-T6	●	●	40	47	300	55	6	37.5	26			
new AIKT-SGC-R/L-40-4-T12	●	●	40	53	300	55	12	37.5	32			

R: Sağ / Right / Rechts L: Sol / Left / Links

● Stokta / In Stock / Auf Lager ○ Stokta Yok / Non Stock Item / Kein Lagerartikel, Lieferzeit auf Anfrage

SMTM Ucuna Uygun. / Compatible with SMTM Insert. / Kompatibel mit SMTM Wendeplatten.

Sipariş Örneği/Ordering Example/Bestellbeispiel

1 ad./pcs./stück AKL-SGC-26-3

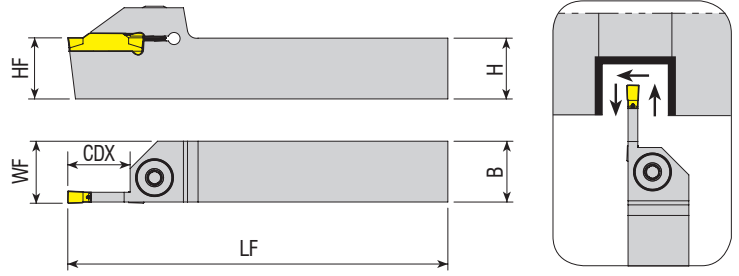

Takım Kodu Ordering Code Bestell-Bezeichnung	Stok Stock Lager		Takım Ölçüleri (mm) Dimension (mm) Abmessung (mm)					Kesici Uç Insert Wendeschneidplatte	Yedek Parçaları / Spare Parts / Ersatzteile			
	R	L	HF=H	B	LF	WF	CDX		Sıkma Vidası Screw Klemmschraube	Pul Stamp Ring	Anahtar Allen Key Innensechskantschlüssel	
ADKT-123-R/L-1212-1.5-R15	●	●	12	12	100	12.2	15	123 - 1.5				
ADKT-123-R/L-1616-1.5-R15	●	●	16	16	125	16.2	15					
ADKT-123-R/L-2012-1.5-R15	○	●	20	12	125	12.5	15					
new ADKT-123-R/L-1212-2-T12	○	●	12	12	125	12.2	12	123 - 2	4015-M4x11	-	80-T15	
ADKT-123-R/L-1616-2-T15	●	○	16	16	125	16.2	15		AKV-02-M6x22	ABPL-01	AAL-03-3	
ADKT-123-R/L-2020-2-T8	●	●	20	20	125	20.2	8		2004-M8x1x20			
ADKT-123-R/L-2020-2-T15	●	●	20	20	125	20.2	15					
ADKT-123-R/L-2525-2-T8	●	●	25	25	150	25.2	8					
ADKT-123-R/L-2525-2-T15	●	●	25	25	150	25.2	15					
ADKT-123-R/L-3232-2-T15	●	●	32	32	170	32.2	15		2004-M8x1x20			
new ADKT-123-R/L-1616-2.5-R17	○	●	16	16	125	16.25	17					123 - 2.5
ADKT-123-R/L-1616-3-T10	●	●	16	16	125	16.3	10	123 - 3				
ADKT-123-R/L-1616-3-T15	●	●	16	16	125	16.3	15					
ADKT-123-R/L-2020-3-T10	●	●	20	20	125	20.3	10					
ADKT-123-R/L-2020-3-T15	●	●	20	20	125	20.3	15					
ADKT-123-R/L-2020-3-T20	●	●	20	20	125	20.3	20					
ADKT-123-R/L-2525-3-T10	●	●	25	25	150	25.3	10					
ADKT-123-R/L-2525-3-T15	●	●	25	25	150	25.3	15					
ADKT-123-R/L-2525-3-T22	●	●	25	25	150	25.3	22					
ADKT-123-R/L-2020-4-T20	●	●	20	20	125	20.4	20	2004-M8x1x20				
ADKT-123-R/L-2525-4-T13	●	●	25	25	150	25.4	13					
ADKT-123-R/L-2525-4-T22	●	●	25	25	150	25.4	22					
ADKT-123-R/L-3232-4-T25	●	●	32	32	170	32.4	25					
ADKT-123-R/L-2020-5-T20	●	●	20	20	125	20.5	20	123 - 5				
ADKT-123-R/L-2525-5-T25	●	●	25	25	150	25.5	25					
ADKT-123-R/L-3232-6-T15	●	●	32	32	170	32.5	15	123 - 6				

R: Sağ / Right / Rechts L: Sol / Left / Links

● Stokta / In Stock / Auf Lager ○ Stokta Yok / Non Stock Item / Kein Lagerartikel, Lieferzeit auf Anfrage

SNDVK Ucuna Uygunur. / Compatible with SNDVK Insert. / Kompatibel mit SNDVK Wendeplatten.

Sipariş Örneği/Ordering Example/Bestellbeispiel

1 ad./pcs./stück ADKT-123-R-1212-1.5-R15

SNDVK Ucuna Uygun. / Compatible with SNDVK Insert. / Kompatibel mit SNDVK Wendeplatten.

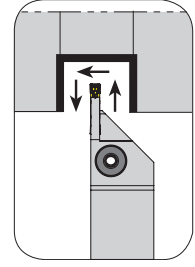
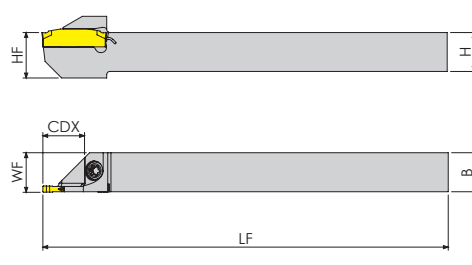

Takım Kodu Ordering Code Bestell-Bezeichnung	Stok Stock Lager		Takım Ölçüleri (mm) Dimension (mm) Abmessung (mm)					Kesici Uç Insert Wendeschneidplatte	Yedek Parçaları / Spare Parts / Ersatzteile		
	R	L	HF=H	B	LF	WF	CDX		Sıkma Vidası Screw Klemmschraube	Pul Stamp Ring	Tork Anahtar Torx Key Torx Innensechskantschlüssel
ADKT-123-R/L-1212-2-T12-K-S	●	○	12	12	125	12.2	12				
ADKT-123-R/L-1212-3-T12-K-S	○	○	12	12	125	12.3	12		4015-M4X11	-	80-T15

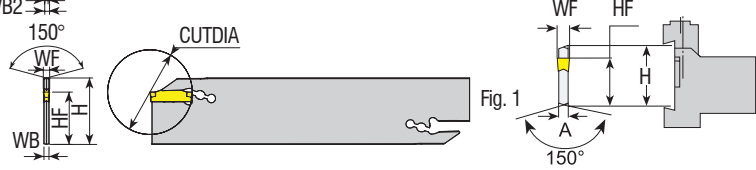
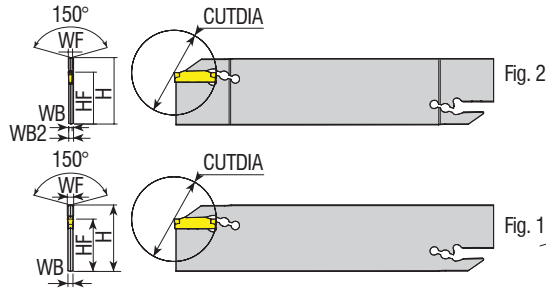

Takım Kodu Ordering Code Bestell-Bezeichnung	Stok Stock Lager	Takım Ölçüleri (mm) Dimension (mm) Abmessung (mm)								Kesici Uç Insert Wendeschneidplatte	Fig.
		H	WF	WB2	WB	I	HF	CUTDIA	Fig.		
AKL-123-32-2	●	32	2	2.4	1.6	150	25	39	2		
AKL-123-32-3	●	32	3	2.4	-	150	25	39	1		
AKL-123-32-4	●	32	4	3.2	-	150	25	39	1		
new AKL-123-32-6	●	32	6	5	-	150	25	55	1		

R: Sağ / Right / Rechts L: Sol / Left / Links

● Stokta / In Stock / Auf Lager ○ Stokta Yok / Non Stock Item / Kein Lagerartikel, Lieferzeit auf Anfrage

Blok bilgileri için sayfa 155'ye gidin. / For block information, go to page 155. / Informationen zu den spannblock finden Sie auf Seite 155.

SNDVK Ucuna Uygun. / Compatible with SNDVK Insert. / Kompatibel mit SNDVK Wendeplatten.

Sipariş Örneği/Ordering Example/Bestellbeispiel

1 ad./pcs./stück ADKT-123-R-1212-2-T12-K-S

SNDVK Ucuna Uygundur. / Compatible with SNDVK Insert. / Kompatibel mit SNDVK Wendeplatten.

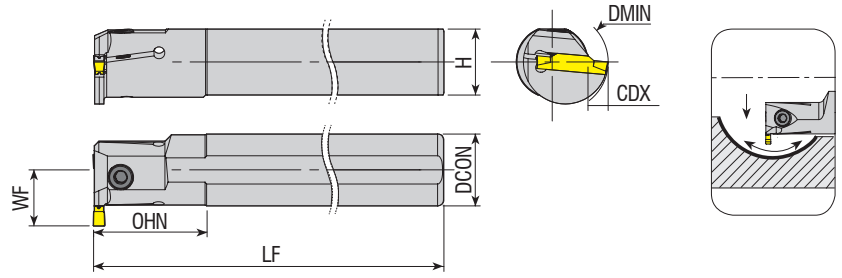

Takım Kodu Ordering Code Bestell-Bezeichnung	Stok Stock Lager		Takım Ölçüleri (mm) Dimension (mm) Abmessung (mm)						Kesici Uç Insert Wendeschneidplatte	Yedek Parçaları / Spare Parts / Ersatzteile		
	R	L	DCON	DMIN	LF	OHN	CDX	H		WF	Sıkma Vidası Screw Klemmschraube	Anahtar Allen Key Innensechskantschlüssel
AIKT-123-R/L-20-2-T6	●	○	20	32	170	30	6	18.3	16	123 - 2	2503-M4x12	AAL-03-3
AIKT-123-R/L-25-2-T6	●	○	25	32	200	40	6	18.3	18.5		2504-M5x12	AAL-05-4
AIKT-123-R/L-32-2-T7	●	○	32	41	250	45	7	30	23	2004-M8x1x20		
AIKT-123-R/L-20-3-T6	●	○	20	32	170	30	6	18.3	16	123 - 3	2504-M5x16	
AIKT-123-R/L-25-3-T7	●	○	25	32	200	40	7	23	19.5		2004-M8x1x20	
AIKT-123-R/L-32-3-T9	●	○	32	41	250	50	9	30	25	2504-M5x16		
AIKT-123-R/L-20-4-T8	●	○	20	29	170	30	8	18.3	18	123 - 4	2504-M5x16	
AIKT-123-R/L-25-4-T7	●	○	25	32	200	40	7	23	19.5		2004-M8x1x20	
AIKT-123-R/L-32-4-T7	●	●	32	41	250	45	7	30	23	123 - 5	2504-M5x16	
AIKT-123-R/L-32-4-T10	●	○	32	43	250	50	10	30	26		2004-M8x1x20	
AIKT-123-R/L-25-5-T8	●	○	25	34	200	40	8	23	20.5	123 - 5	2504-M5x16	
AIKT-123-R/L-32-5-T11	●	●	32	43	250	50	11	30	27		2004-M8x1x20	

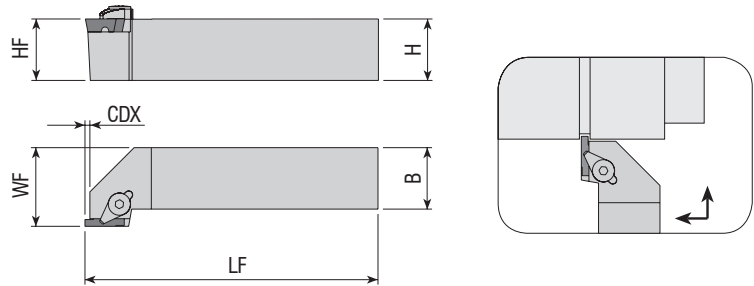

Takım Kodu Ordering Code Bestell-Bezeichnung	Stok Stock Lager		Takım Ölçüleri (mm) Dimension (mm) Abmessung (mm)				Kesici Uç Insert Wendeschneidplatte	Yedek Parçaları / Spare Parts / Ersatzteile				
	R	L	HF=H	B	LF	WF		CDX	Baskı Parçası Wedge Clamp Spannspratze	Sıkma Vidası Screw Klemmschraube	Pul Stamp Ring	Anahtar Allen Key Innensechskantschlüssel
ADKT-154.91-R/L-2020-3-T4	●	●	20	20	125	25	4	154.91 - 3	ACK-03	AKV-07-M6x22	APM-06	AAL-03-3
ADKT-154.91-R/L 2525-3-T4	●	●	25	25	150	30.5	4					
ADKT-154.91-R/L 2020-5-T5	●	●	20	20	125	25	5	154.91 - 5	ACK-03	AKV-07-M6x22	APM-06	AAL-03-3
ADKT-154.91-R/L 2525-5-T5	●	●	25	25	150	30.5	5					

R: Sağ / Right / Rechts L: Sol / Left / Links

● Stokta / In Stock / Auf Lager ○ Stokta Yok / Non Stock Item / Kein Lagerartikel, Lieferzeit auf Anfrage

SNDVK Ucuna Uygundur. / Compatible with SNDVK Insert. / Kompatibel mit SNDVK Wendeplatten.

Sipariş Örneği/Ordering Example/Bestellbeispiel

1 ad./pcs./stück AIKT-123-R-20-2-T6

SNDVK Ucuna Uygun. / Compatible with SNDVK Insert. / Kompatibel mit SNDVK Wendeplatten.

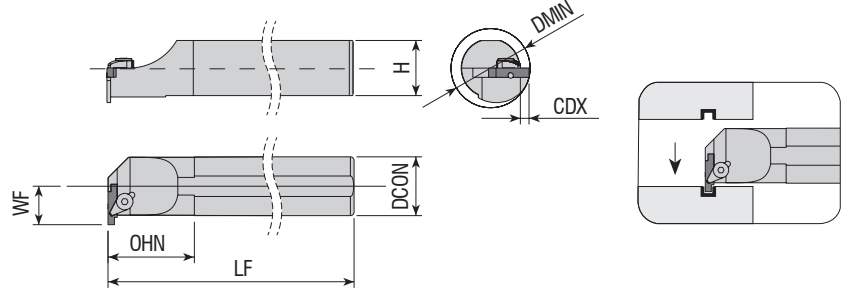

Takım Kodu Ordering Code Bestell-Bezeichnung	Stok Stock Lager		Takım Ölçüleri (mm) Dimension (mm) Abmessung (mm)							Kesici Uç Insert Wendeschneidplatte	Yedek Parçaları / Spare Parts / Ersatzteile			
	R	L	DCON	DMIN	LF	OHN	CDX	H	WF		Baskı Parçası Wedge Clamp Spannpratze	Sıkma Vidası Screw Klemmschraube	Pim Pin Stift	Anahtar Allen Key Innensechskantschlüssel
AIKT-154.91-R/L-16-3-T3	●	●	16	20	150	35	3	14.8	11	154.91 - 3	ACK-06	AKV-10-M6x14	APM-06	AAL-05-4
AIKT-154.91-R/L-20-3-T4	●	●	20	25	170	38	4	18.3	14					
AIKT-154.91-R/L-25-3-T4	●	●	25	31	200	40	4	23	16.5	154.91 - 5	ACK-03	AKV-21-M6x18 AKV-07-M6x22	AAL-03-3	
AIKT-154.91-R/L-25-5-T5	●	●	25	31	200	45	5	23	17.5					
AIKT-154.91-R/L-32-5-T5	●	●	32	38	250	50	5	30	21					

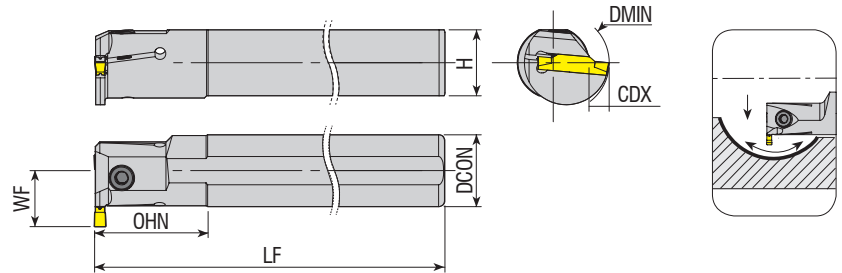

Takım Kodu Ordering Code Bestell-Bezeichnung	Stok Stock Lager		Takım Ölçüleri (mm) Dimension (mm) Abmessung (mm)							Kesici Uç Insert Wendeschneidplatte	Yedek Parçaları / Spare Parts / Ersatzteile	
	R	L	DCON	DMIN	LF	OHN	CDX	H	WF		Sıkma Vidası Screw Klemmschraube	Anahtar Allen Key Innensechskantschlüssel
AIKT-151.23-R/L-20-2-T6	●	○	20	32	170	30	6	18.3	16	151.23 - 2	2503-M4x12	AAL-03-3
AIKT-151.23-R/L-20-2.5-T6	●	○	20	32	170	30	6	18.3	16			
AIKT-151.22-R/L-25-3-T6	○	●	25	37	200	32	6	23	18.5	151.23 - 3		
AIKT-151.22-R/L-25-3-T6-H	○	●	25	37	200	32	6	23	18.5			

R: Sağ / Right / Rechts L: Sol / Left / Links

● Stokta / In Stock / Auf Lager ○ Stokta Yok / Non Stock Item / Kein Lagerartikel, Lieferzeit auf Anfrage

SNDVK Ucuna Uygun. / Compatible with SNDVK Insert. / Kompatibel mit SNDVK Wendeplatten.

Sipariş Örneği/Ordering Example/Bestellbeispiel

1 ad./pcs./stück AIKT-154.91-R/L-16-3-T3

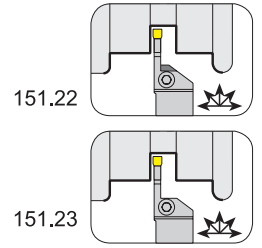
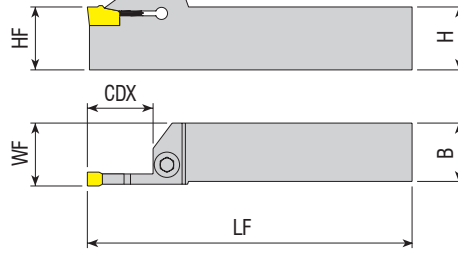

Takım Kodu Ordering Code Bestell-Bezeichnung	Stok Stock Lager		Takım Ölçüleri (mm) Dimension (mm) Abmessung (mm)				Kesici Uç Insert Wendeschneidplatte	Yedek Parçaları / Spare Parts / Ersatzteile			
	R	L	HF=H	B	LF	WF		CDX	Sıkma Vidası Screw Klemmschraube	Pul Stamp Ring	Anahtar Allen Key Innensechskantschlüssel
ADKT-151.22-R/L-1616-2-T15	●	●	16	16	125	16.3	15	151.2 - 2	AKV-02-M6x22	ABPL-01	AAL-03-3
ADKT-151.22-R/L-2020-2-T15	●	●	20	20	125	20.3	15				
ADKT-151.22-R/L-2525-2-T15	●	●	25	25	150	25.3	15	151.2 - 3	2004-M8x1x20	-	AAL-05-4
ADKT-151.22-R/L-1616-3-T15	●	●	16	16	125	16.4	15				
ADKT-151.22-R/L-2020-3-T20	●	●	20	20	125	20.4	20	151.2 - 4	2004-M8x1x20	-	AAL-05-4
ADKT-151.22-R/L-2525-3-T22	●	●	25	25	150	25.4	22				
ADKT-151.22-R/L-1616-4-T15	●	●	16	16	125	16.4	15	151.2 - 5	2004-M8x1x20	-	AAL-05-4
ADKT-151.22-R/L-2020-4-T20	●	●	20	20	125	20.4	20				
ADKT-151.22-R/L-2525-4-T22	●	●	25	25	150	25.4	22	151.2 - 5	2004-M8x1x20	-	AAL-05-4
ADKT-151.22-R/L-2020-5-T20	●	●	20	20	125	20.5	20				
ADKT-151.22-R/L-2525-5-T25	●	●	25	25	150	25.5	25	151.2 - 2	AKV-02-M6x22	ABPL-01	AAL-03-3
ADKT-151.23-R/L-1616-2-T15	●	●	16	16	125	16.3	15				
ADKT-151.23-R/L-2020-2-T15	●	●	20	20	125	20.3	15	151.2 - 2.5	2004-M8x1x20	-	AAL-05-4
ADKT-151.23-R/L-2525-2-T15	●	●	25	25	150	25.3	15				
ADKT-151.23-R/L-1616-2.5-T15	●	●	16	16	125	16.3	15	151.2 - 3	2004-M8x1x20	-	AAL-05-4
ADKT-151.23-R/L-2020-2.5-T15	●	●	20	20	125	20.3	15				
ADKT-151.23-R/L-2525-2.5-T15	●	●	25	25	150	25.3	15	151.2 - 4	2004-M8x1x20	-	AAL-05-4
ADKT-151.23-R/L-1212-3-T15	●	●	12	12	100	16.4	15				
ADKT-151.23-R/L-1616-3-T15	●	●	16	16	125	16.4	15	151.2 - 5	2004-M8x1x20	-	AAL-05-4
ADKT-151.23-R/L-2020-3-T20	●	●	20	20	125	20.4	20				
ADKT-151.23-R/L-2525-3-T20	●	●	25	25	150	25.4	20	151.2 - 4	2004-M8x1x20	-	AAL-05-4
ADKT-151.23-R/L-2525-3-T22	●	●	25	25	150	25.4	22				
ADKT-151.23-R/L-1616-4-T15	●	●	16	16	125	16.4	15	151.2 - 5	2004-M8x1x20	-	AAL-05-4
ADKT-151.23-R/L-2020-4-T20	●	●	20	20	125	20.4	20				
ADKT-151.23-R/L-2525-4-T22	●	●	25	25	150	25.4	22	151.2 - 5	2004-M8x1x20	-	AAL-05-4
ADKT-151.23-R/L-2020-5-T20	●	●	20	20	125	20.5	20				
ADKT-151.23-R/L-2525-5-T25	●	●	25	25	150	25.5	25				

R: Sağ / Right / Rechts L: Sol / Left / Links

● Stokta / In Stock / Auf Lager ○ Stokta Yok / Non Stock Item / Kein Lagerartikel, Lieferzeit auf Anfrage

SNDVK Ucuna Uygundur. / Compatible with SNDVK Insert. / Kompatibel mit SNDVK Wendeplatten.

Sipariş Örneği/Ordering Example/Bestellbeispiel

1 ad./pcs./stück ADKT-151.22-R-1616-2-T15

SNDVK Ucuna Uygun. / Compatible with SNDVK Insert. / Kompatibel mit SNDVK Wendeplatten.

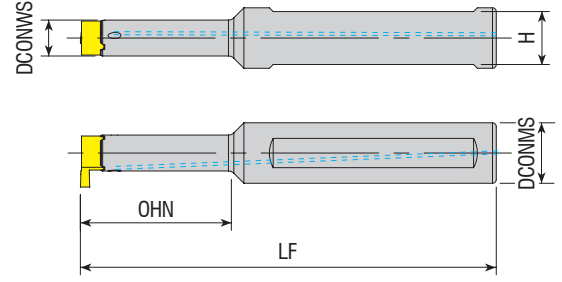

Takım Kodu Ordering Code Bestell-Bezeichnung	Stok Stock Lager		Takım Ölçüleri (mm) Dimension (mm) Abmessung (mm)				Kesici Uç Insert Wendeschneidplatte	Yedek Parçaları / Spare Parts / Ersatzteile		
	●	○	DCONMS	DCONWS	LF	OHN		H	Sıkma Vidası Screw Klemmschraube	Tork Anahtar Torx Key Torx Innensechskantschlüssel
AIKT-MB07-A16-090-15	●		16	7.4	90	15	14	MB - 07	4008-M3x8	82-T08
AIKT-MB07-A16-090-22	●		16	7.4	90	22	14			
AIKT-MB09-A16-090-19	●		16	9.5	90	19	14	MB - 09	4015-M4x11	80-T15
AIKT-MB09-A16-095-28	●		16	9.5	95	28	14			
AIKT-MB09-A16-110-40	●		16	9.5	110	40	14			

SNDVK Ucuna Uygun. / Compatible with SNDVK Insert. / Kompatibel mit SNDVK Wendeplatten.

TGTC Ucuna Uygun. / Compatible with TGTC Insert. / Kompatibel mit TGTC Wendeplatten.

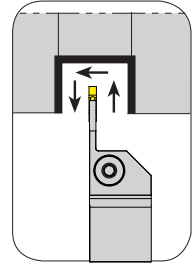
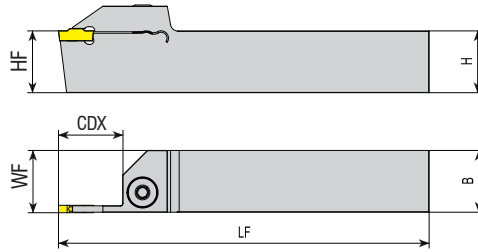

Takım Kodu Ordering Code Bestell-Bezeichnung	Stok Stock Lager		Takım Ölçüleri (mm) Dimension (mm) Abmessung (mm)				Kesici Uç Insert Wendeschneidplatte	Yedek Parçaları / Spare Parts / Ersatzteile				
	R	L	HF=H	B	LF	WF		CDX	Sıkma Vidası Screw Klemmschraube	Pul Stamp Ring	Anahtar Allen Key Innensechskantschlüssel	Tork Anahtar Torx Key Torx Innensechskantschlüssel
ADKT-RD-R/L-1616-2-T17	●	○	16	16	125	16.2	17	RD. - 2	AKV-02-M6x22	ABPL-01	AAL-03-3	
ADKT-RD-R/L-2020-2-T17	●	○	20	20	125	20.2	17					
ADKT-RD-R/L-2525-2-T17	●	○	25	25	150	25.2	17					
ADKT-RD-R/L-1616-3-T20	●	●	16	16	125	16.3	20	RD. - 3	2004-M8x1x20	-	AAL-05-4	
ADKT-RD-R/L-2020-3-T25	●	○	20	20	125	20.3	25					
ADKT-RD-R/L-2525-3-T25	●	○	25	25	150	25.3	25					
ADKT-RD-R/L-2020-4-T30	●	●	20	20	125	20.4	30	RD. - 4				
ADKT-RD-R/L-2525-4-T30	●	○	25	25	150	25.5	30					

R: Sağ / Right / Rechts L: Sol / Left / Links

● Stokta / In Stock / Auf Lager ○ Stokta Yok / Non Stock Item / Kein Lagerartikel, Lieferzeit auf Anfrage

TGTC Ucuna Uygun. / Compatible with TGTC Insert. / Kompatibel mit TGTC Wendeplatten.

Sipariş Örneği/Ordering Example/Bestellbeispiel
1 ad./pcs./stück AIKT-MB07-A16-090-15

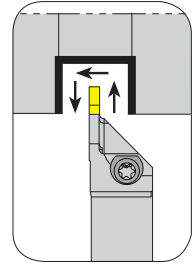
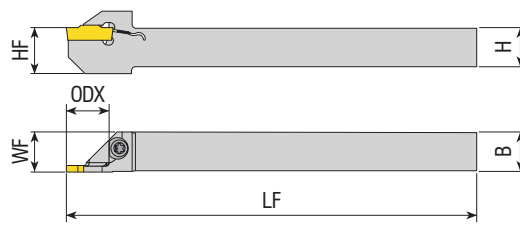

Takım Kodu
Ordering Code
Bestell-Bezeichnung

Takım Kodu Ordering Code Bestell-Bezeichnung	Stok Stock Lager		Takım Ölçüleri (mm) Dimension (mm) Abmessung (mm)				Kesici Uç Insert Wendeschneidplatte	Yedek Parçaları / Spare Parts / Ersatzteile			
	R	L	HF=H	B	LF	WF		CDX	Sıkma Vidası Screw Klemmschraube	Pul Stamp Ring	Tork Anahtar Torx Key Torx Innensechskantschlüssel
ADKT-RD-R/L-1212-2-T12-K-S	●	●	12	12	125	12.2	12	RD. - 2	4015-M4x11	-	80-T15
ADKT-RD-R/L-1616-2-T17-K-S	●	●	16	16	125	16.2	17				
ADKT-RD-R/L-1212-3-T12-K-S	●	●	12	12	125	12.2	12	RD. - 3			

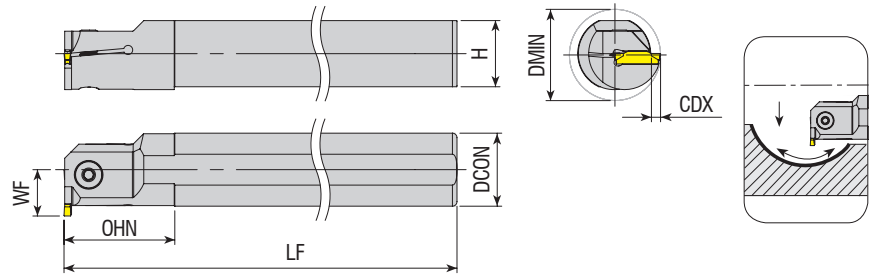

Takım Kodu Ordering Code Bestell-Bezeichnung	Stok Stock Lager		Takım Ölçüleri (mm) Dimension (mm) Abmessung (mm)						Kesici Uç Insert Wendeschneidplatte	Yedek Parçaları / Spare Parts / Ersatzteile		
	R	L	DCON	DMIN	LF	OHN	CDX	H		WF	Sıkma Vidası Screw Klemmschraube	Anahtar Allen Key Innensechskantschlüssel
AIKT-RD-R/L-16-2-T6	●	○	16	24	150	28	6	14.8	14	RD. - 2	2503-M4x10	AAL-03-3
AIKT-RD-R/L-20-2-T6	●	○	20	28	170	28	6	18.3	16		2504-M5x16	AAL-05-4
AIKT-RD-R/L-25-2-T6	●	○	25	33	200	28	6	23	18.5	RD. - 3	2503-M4x10	AAL-03-3
AIKT-RD-R/L-16-3-T6	●	○	16	24	150	28	6	14.8	14		2504-M5x12	AAL-05-4
AIKT-RD-R/L-20-3-T6	●	○	20	28	170	28	6	18.3	16	2504-M5x16		
AIKT-RD-R/L-25-3-T6	●	○	25	33	200	28	6	23	18.5	2004-M8x1x20		
AIKT-RD-R/L-32-3-T6	●	○	32	40	250	50	6	30	22	RD. - 4	2504-M5x12	AAL-05-4
AIKT-RD-R/L-20-4-T6	●	○	20	28	170	28	6	18.3	16		2504-M5x16	
AIKT-RD-R/L-25-4-T6	●	○	25	33	200	28	6	23	18.5	2004-M8x1x20		
AIKT-RD-R/L-32-4-T6	●	○	32	40	250	50	6	30	22			

R: Sağ / Right / Rechts L: Sol / Left / Links

● Stokta / In Stock / Auf Lager ○ Stokta Yok / Non Stock Item / Kein Lagerartikel, Lieferzeit auf Anfrage

TGTC Ucuna Uygun. / Compatible with TGTC Insert. / Kompatibel mit TGTC Wendeplatten.

Sipariş Örneği/Ordering Example/Bestellbeispiel

1 ad./pcs./stück ADKT-RD-R-1212-2-T12-K-S

TGTC Ucuna Uygundur. / Compatible with TGTC Insert. / Kompatibel mit TGTC Wendeplatten.

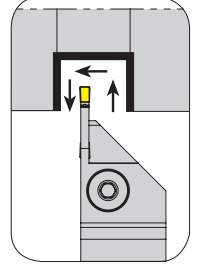
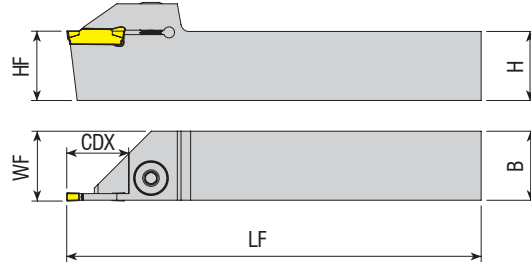

Takım Kodu Ordering Code Bestell-Bezeichnung	Stok Stock Lager		Takım Ölçüleri (mm) Dimension (mm) Abmessung (mm)				Kesici Uç Insert Wendeschneidplatte	Yedek Parçaları / Spare Parts / Ersatzteile			
	R	L	HF=H	B	LF	WF		CDX	Sıkma Vidası Screw Klemmschraube	Pul Stamp Ring	Anahtar Allen Key Innensechskantschlüssel
ADKT-TD-R/L-1212-2-T15	●	●	12	12	100	12.2	15	TD. - 2	AKV-02-M6x22	ABPL-01	AAL-03-3
ADKT-TD-R/L-1616-2-T8	●	●	16	16	125	16.2	8				
ADKT-TD-R/L-1616-2-T15	●	●	16	16	125	16.2	15				
ADKT-TD-R/L-2020-2-T9	●	○	20	20	125	20.2	9				
ADKT-TD-R/L-2020-2-T15	●	●	20	20	125	20.2	15				
ADKT-TD-R/L-2020-2-T17	●	○	20	20	125	20.2	17				
ADKT-TD-R/L-2020-2-T20	●	○	20	20	125	20.2	20				
ADKT-TD-R/L-2525-2-T8	●	●	25	25	150	25.2	8				
ADKT-TD-R/L-2525-2-T17	●	●	25	25	150	25.2	17				
ADKT-TD-R/L-1212-3-T15	●	●	12	12	100	12.4	15				
ADKT-TD-R/L-1616-3-T15	●	●	16	16	125	16.4	15				
ADKT-TD-R/L-2020-3-T12	●	●	20	20	125	20.4	12				
ADKT-TD-R/L-2020-3-T20	●	●	20	20	125	20.4	20				
ADKT-TD-R/L-2020-3-T25	●	○	20	20	125	20.4	25				
ADKT-TD-R/L-2020-3-T30	●	●	20	20	125	20.4	30				
ADKT-TD-R/L-2525-3-T9	●	●	25	25	150	25.4	9				
ADKT-TD-R/L-2525-3-T12	●	●	25	25	150	25.4	12				
ADKT-TD-R/L-2525-3-T22	●	●	25	25	150	25.4	22				
ADKT-TD-R/L-2525-3-T25	●	●	25	25	150	25.4	25				
ADKT-TD-R/L-2525-3-T30	●	●	25	25	150	25.4	30	TD. - 4			
ADKT-TD-R/L-3232-3-T25	●	○	32	32	170	32.4	25				
ADKT-TD-R/L-2525-4-T10	●	●	25	25	150	25.5	10				
ADKT-TD-R/L-2525-4-T15	●	●	25	25	150	25.5	15				
ADKT-TD-R/L-2525-4-T22	●	●	25	25	150	25.5	22				
ADKT-TD-R/L-2525-4-T25	●	○	25	25	150	25.4	25	TD. - 5			
ADKT-TD-R/L-2525-4-T30	●	○	25	25	150	25.5	30				
ADKT-TD-R/L-2525-5-T25	●	●	25	25	150	25.5	25				

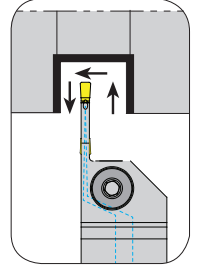
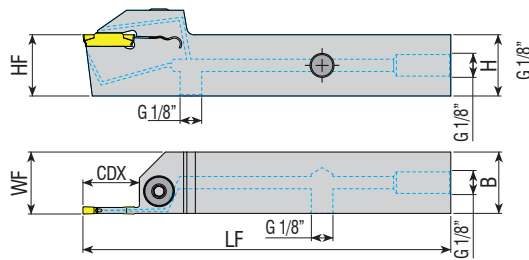

Takım Kodu Ordering Code Bestell-Bezeichnung	Stok Stock Lager		Takım Ölçüleri (mm) Dimension (mm) Abmessung (mm)				Kesici Uç Insert Wendeschneidplatte	Yedek Parçaları / Spare Parts / Ersatzteile			
	R	L	HF=H	B	LF	WF		CDX	Sıkma Vidası Screw Klemmschraube	Pul Stamp Ring	Anahtar Allen Key Innensechskantschlüssel
ADKT-TD-R/L-2020-3-T30-H	●	●	20	20	125	20.5	30	TD. - 3	2004-M8x1x20	-	AAL-05-4

R: Sağ / Right / Rechts L: Sol / Left / Links
● Stokta / In Stock / Auf Lager ○ Stokta Yok / Non Stock Item / Kein Lagerartikel, Lieferzeit auf Anfrage
TGTC Ucuna Uygundur. / Compatible with TGTC Insert. / Kompatibel mit TGTC Wendeplatten.

Sipariş Örneği/Ordering Example/Bestellbeispiel
1 ad./pcs./stück ADKT-TD-R-1212-2-T15

TGTC Ucuna Uygundur. / Compatible with TGTC Insert. / Kompatibel mit TGTC Wendeplatten.

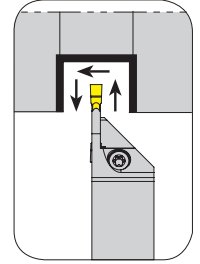
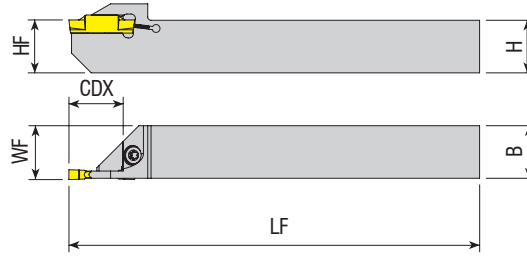

Takım Kodu Ordering Code Bestell-Bezeichnung	Stok Stock Lager		Takım Ölçüleri (mm) Dimension (mm) Abmessung (mm)				Kesici Uç Insert Wendeschneidplatte	Yedek Parçaları / Spare Parts / Ersatzteile			
	R	L	HF=H	B	LF	WF		CDX	Sıkma Vidası Screw Klemmschraube	Pul Stamp Ring	Tork Anahtar Torx Key Torx Innensechskantschlüssel
ADKT-TD-R/L-1010-2-R10-K-S	●	●	10	10	125	10.2	10	TD. - 2	4015-M4x11	-	80-T15
ADKT-TD-R/L-1212-2-T12-K-S	●	●	12	12	125	12.2	12				
ADKT-TD-R/L-1616-2-T16-K-S	●	●	16	16	125	16.2	16				
ADKT-TD-R/L-1212-3-T12-K-S	●	●	12	12	125	12.3	12	TD. - 3			
ADKT-TD-R/L-1616-3-T16-K-S	●	●	16	16	125	16.3	16				

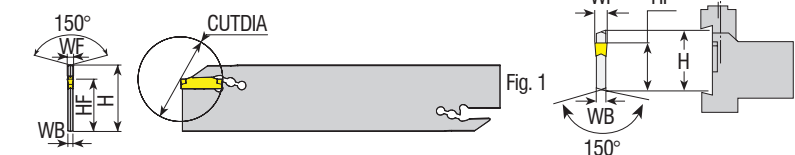
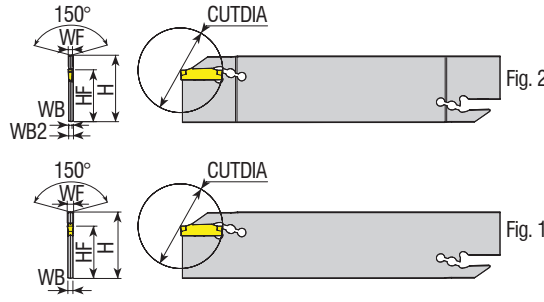

Takım Kodu Ordering Code Bestell-Bezeichnung	Stok Stock Lager	Takım Ölçüleri (mm) Dimension (mm) Abmessung (mm)								Kesici Uç Insert Wendeschneidplatte	Yedek Parçaları / Spare Parts / Ersatzteile
		H	WF	WB2	WB	I	HF	CUTDIA	Fig.		Anahtar Allen Key Innensechskantschlüssel
AKL-TD-32-2	●	32	2	2.4	1.6	150	25	39	2	TD. - 2	ALA-02
AKL-TD-26-3	●	26	3	-	2.40	110	26	40	1	TD. - 3	
AKL-TD-32-3	●	32	3	2.4	-	150	25	39	1	TD. - 4	
AKL-TD-26-4	●	26	4	-	3.20	110	26	40	1	TD. - 5	
AKL-TD-32-5	●	32	5	-	4	150	25	40	1		

Blok bilgileri için sayfa 155'ye gidin. / For block information, go to page 155. / Informationen zu den spannblock finden Sie auf Seite 155.

TGTC Ucuna Uygundur. / Compatible with TGTC Insert. / Kompatibel mit TGTC Wendeplatten.

Sipariş Örneği/Ordering Example/Bestellbeispiel
1 ad./pcs./stück ADKT-TD-R-1010-2-R10-K-S

TGTC Ucuna Uygundur. / Compatible with TGTC Insert. / Kompatibel mit TGTC Wendeplatten.

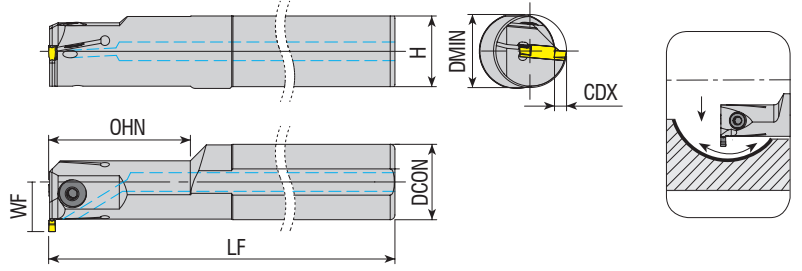

Takım Kodu
Ordering Code
Bestell-Bezeichnung

Stok
Stock
Lager

Takım Ölçüleri (mm)
Dimension (mm)
Abmessung (mm)

Kesici Uç
Insert
Wendeschneidplatte

Yedek Parçaları / Spare Parts / Ersatzteile

Sıkma Vidası
Screw
Klemmschraube

Anahtar
Allen Key
Innensechskantschlüssel

R

L

DCON

DMIN

LF

OHN

CDX

H

WF



Takım Kodu Ordering Code Bestell-Bezeichnung	R	L	DCON	DMIN	LF	OHN	CDX	H	WF
AIKT-TD-R/L-16-2-T8.5-H	●	○	16	25	150	28	8.5	14.8	16.5
AIKT-TD-R/L-20-3-T6-H	●	○	20	25	170	40	6	18.3	16
AIKT-TD-R/L-25-3-T6-H	●	○	25	25	200	40	6	23	18.5
AIKT-TD-R/L-32-3-T5-H	●	○	32	31	250	60	5	30	21
new AIKT-TD-R/L-32-3-T10-H	●	○	32	36	250	78	10	30	26
new AIKT-TD-R/L-40-3-T12-H	●	○	40	45	300	78	12	37.5	12
AIKT-TD-R/L-20-4-T10-H	○	●	20	27	170	40	10	18.3	20
AIKT-TD-R/L-25-4-T10-H	○	●	25	31	200	40	10	23	22.5
AIKT-TD-R/L-32-4-T10-H	○	●	32	36	250	60	10	30	26

TD - 2

2503-M4x10

AAL-03-3

TD - 3

2504-M5x12

2504-M5x16

2004-M8x1x20

TD - 4

2504-M5x12

2504-M5x16

2004-M8x1x20

AAL-05-4

TGTC Ucuna Uygundur. / Compatible with TGTC Insert. / Kompatibel mit TGTC Wendeplatten.

TNGLY Ucuna Uygundur. / Compatible with TNGLY Insert. / Kompatibel mit TNGLY Wendeplatten.

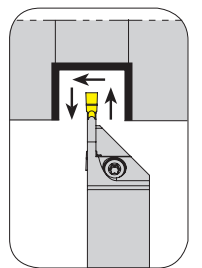
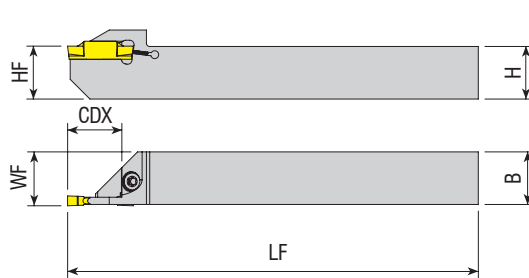

Takım Kodu
Ordering Code
Bestell-Bezeichnung

Stok
Stock
Lager

Takım Ölçüleri (mm)
Dimension (mm)
Abmessung (mm)

Kesici Uç
Insert
Wendeschneidplatte

Yedek Parçaları / Spare Parts / Ersatzteile

Sıkma Vidası
Screw
Klemmschraube

Pul
Stamp
Ring

Tork Anahtar
Torx Key
Torx Innensechskantschlüssel

R

L

HF=H

B

LF

WF

CDX



Takım Kodu Ordering Code Bestell-Bezeichnung	R	L	HF=H	B	LF	WF	CDX
ADKT-TG-R/L-1212-2-R12-K-S	●	○	12	12	125	12.2	12
ADKT-TG-R/L-1212-3-R12-K-S	●	○	12	12	125	12.3	12

DGM2-020

4015-M4x11

-

80-T15

R: Sağ / Right / Rechts L: Sol / Left / Links

● Stokta / In Stock / Auf Lager ○ Stokta Yok / Non Stock Item / Kein Lagerartikel, Lieferzeit auf Anfrage

TNGLY Ucuna Uygundur. / Compatible with TNGLY Insert. / Kompatibel mit TNGLY Wendeplatten.

Sipariş Örneği/Ordering Example/Bestellbeispiel
1 ad./pcs./stück AIKT-TD-R-16-2-T8.5-H

TNGLY Ucuna Uygundur. / Compatible with TNGLY Insert. / Kompatibel mit TNGLY Wendeplatten.

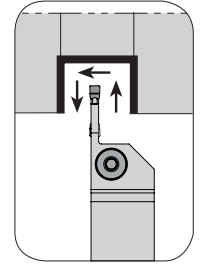
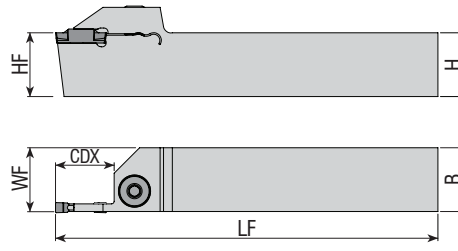

Takım Kodu Ordering Code Bestell-Bezeichnung	Stok Stock Lager		Takım Ölçüleri (mm) Dimension (mm) Abmessung (mm)					Kesici Uç Insert Wendeschneidplatte	Yedek Parçaları / Spare Parts / Ersatzteile			
	R	L	HF=H	B	LF	WF	CDX		Sıkma Vidası Screw Klemmschraube	Pul Stamp Ring	Anahtar Allen Key Innensechskantschlüssel	
ADKT-TG-R/L-1616-2-R17	●	○	16	16	125	16.2	17	DGM2-020	AKV-02-M6x22	ABPL-01	AAL-03-3	
ADKT-TG-R/L-2020-2-T8	●	○	20	20	125	20.2	8					
ADKT-TG-R/L-2020-2-R12	●	○	20	20	125	20.2	12					
ADKT-TG-R/L-2020-2-R17	●	○	20	20	125	20.2	17					
ADKT-TG-R/L-2525-2-T12	●	○	25	25	150	25.2	12					
ADKT-TG-R/L-2525-2-R17	●	○	25	25	150	25.2	17	DGM3-020	2004-M8x1x20	-	AAL-05-4	
ADKT-TG-R/L-1616-3-T20	●	○	16	16	125	16.3	20					
ADKT-TG-R/L-2020-3-T12	●	○	20	20	125	20.3	12					
ADKT-TG-R/L-2020-3-T20	●	○	20	20	125	20.3	20					
ADKT-TG-R/L-2525-3-T9	●	○	25	25	150	25.3	9					
ADKT-TG-R/L-2525-3-T20	●	○	25	25	150	25.3	20					
ADKT-TG-R/L-2525-3-R25	●	○	25	25	150	25.3	25					
ADKT-TG-R/L-2525-4-T15	●	○	25	25	150	25.5	15					
ADKT-TG-R/L-2525-4-T20	●	○	25	25	150	25.5	20					
ADKT-TG-R/L-2525-4-T25	●	○	25	25	150	25.5	25					
ADKT-TG-R/L-2525-5-T12	●	○	25	25	150	25.5	12	DGM4-030	2004-M8x1x20	-	AAL-05-4	
ADKT-TG-R/L-2525-5-T25	●	○	25	25	150	25.5	25					
ADKT-TG-R/L-2525-5-T32	●	○	25	25	150	25.5	32					

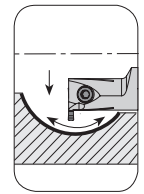
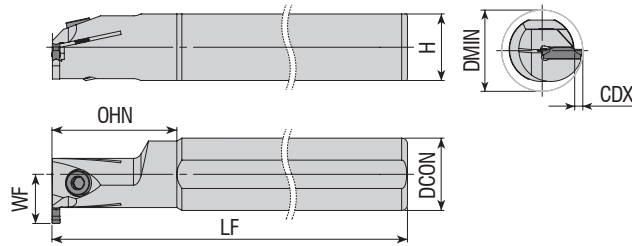

Takım Kodu Ordering Code Bestell-Bezeichnung	Stok Stock Lager		Takım Ölçüleri (mm) Dimension (mm) Abmessung (mm)						Kesici Uç Insert Wendeschneidplatte	Yedek Parçaları / Spare Parts / Ersatzteile		
	R	L	DCON	DMIN	LF	OHN	CDX	H		WF	Sıkma Vidası Screw Klemmschraube	Tork Anahtar Torx Key Torx Innensechskantschlüssel
AIKT-TG-R/L-20-2-T6	●	○	20	28	160	28	6	18.3	15.8	DGM2-020	2503-M4x10 2504-M5x12 2504-M5x16	AAL-03-3
AIKT-TG-R/L-20-3-T6	●	○	20	28	160	28	6	18.3	15.8			
AIKT-TG-R/L-25-3-T8	●	○	25	35	200	28	8	23	21.5			
AIKT-TG-R/L-32-3-T10	●	○	32	43	250	50	10	30	27	DTX3-030	2004-M8x1x20	AAL-05-4
AIKT-TG-R/L-32-3-T12	●	○	32	45	250	50	12	30	27			
AIKT-TG-R/L-32-4-T10	●	○	32	43	250	50	10	30	27	DTX4-040 DTX5-040	2004-M8x1x20	AAL-05-4
AIKT-TG-R/L-32-5-T10	●	○	32	43	250	50	10	30	27			

R: Sağ / Right / Rechts L: Sol / Left / Links

● Stokta / In Stock / Auf Lager ○ Stokta Yok / Non Stock Item / Kein Lagerartikel, Lieferzeit auf Anfrage

TNGLY Ucuna Uygundur. / Compatible with TNGLY Insert. / Kompatibel mit TNGLY Wendeplatten.

Sipariş Örneği/Ordering Example/Bestellbeispiel

1 ad./pcs./stück ADKT-TG-R-1616-2-R17

WLTR Ucuna Uygundur. / Compatible with WLTR Insert. / Kompatibel mit WLTR Wendeplatten.

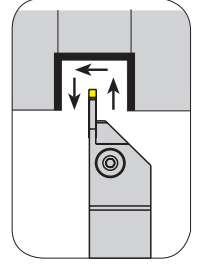
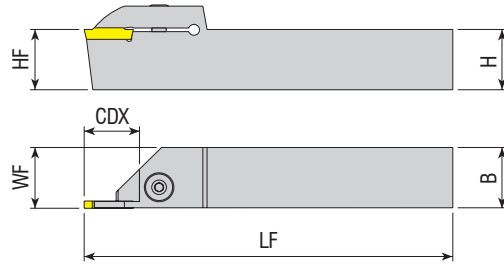

Takım Kodu Ordering Code Bestell-Bezeichnung	Stok Stock Lager		Takım Ölçüleri (mm) Dimension (mm) Abmessung (mm)					Kesici Uç Insert Wendeschneidplatte	Yedek Parçaları / Spare Parts / Ersatzteile			
	R	L	HF=H	B	LF	WF	CDX		Sıkma Vidası Screw Klemmschraube	Pul Stamp Ring	Anahtar Allen Key Innensechskantschlüssel	
ADKT-WGX16-R/L-2020-2-R16	●	○	20	20	125	20.2	16	GX16. - 2	AKV-02-M6x22	ABPL-01	AAL-03-3	
ADKT-WGX16-R/L-2525-2-R16	●	○	25	25	150	25.2	16					
ADKT-WGX24-R/L-2020-3-T20	●	●	20	20	125	20.4	20	GX24. - 3	2004-M8x1x20	-	AAL-05-4	
ADKT-WGX24-R/L-2525-3-T12	●	●	25	25	150	25.4	12					
ADKT-WGX24-R/L-2525-3-T22	●	●	25	25	150	25.4	22					
ADKT-WGX24-R/L-3232-3-T22	●	○	32	32	170	32.4	22					
ADKT-WGX24-R/L-2525-4-T22	●	●	25	25	150	25.5	22					
ADKT-WGX24-R/L-2525-5-T25	●	●	25	25	150	25.5	25	GX24. - 5				
ADKT-WGX24-R/L-3232-5-T25	●	●	32	32	170	32.5	25					

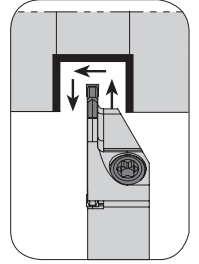
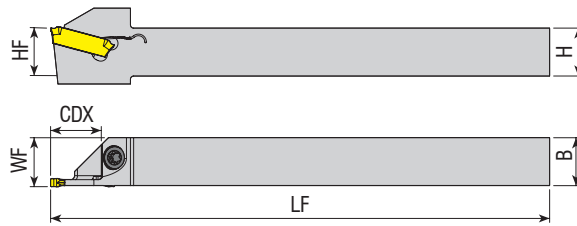

Takım Kodu Ordering Code Bestell-Bezeichnung	Stok Stock Lager		Takım Ölçüleri (mm) Dimension (mm) Abmessung (mm)					Kesici Uç Insert Wendeschneidplatte	Yedek Parçaları / Spare Parts / Ersatzteile			
	R	L	HF=H	B	LF	WF	CDX		Sıkma Vidası Screw Klemmschraube	Pul Stamp Ring	Tork Anahtar Torx Key Torx Innensechskantschlüssel	
ADKT-WGX16-R/L-1212-2-R12-K-S	●	●	12	12	125	12.2	12	GX16. - 2	4015-M4x11	-	80-T15	
ADKT-WGX16-R/L-1616-2-R16-K-S	●	○	16	16	125	16.2	16					
ADKT-WGX24-R/L-1616-3-R16-K-S	●	○	16	16	125	16.3	16	GX24. - 3				

R: Sağ / Right / Rechts L: Sol / Left / Links

● Stokta / In Stock / Auf Lager ○ Stokta Yok / Non Stock Item / Kein Lagerartikel, Lieferzeit auf Anfrage

WLTR Ucuna Uygundur. / Compatible with WLTR Insert. / Kompatibel mit WLTR Wendeplatten.

Sipariş Örneği/Ordering Example/Bestellbeispiel

1 ad./pcs./stück ADKT-WGX16-R-2020-2-R16

WLTR Ucuna Uygundur. / Compatible with WLTR Insert. / Kompatibel mit WLTR Wendeplatten.

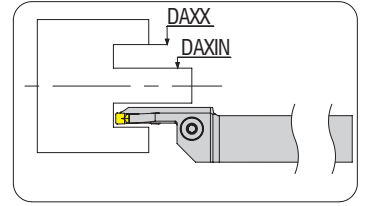
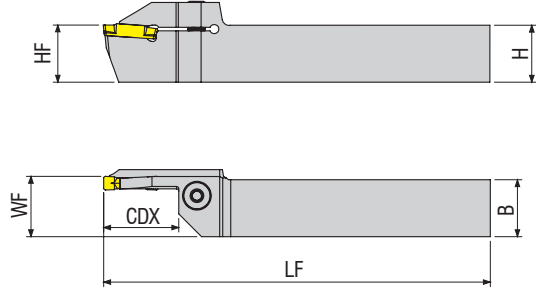

Takım Kodu
Ordering Code
Bestell-Bezeichnung

Stok
Stock
Lager

Takım Ölçüleri (mm)
Dimension (mm)
Abmessung (mm)

Kesici Uç
Insert
Wendeschneidplatte

Yedek Parçaları / Spare Parts / Ersatzteile

Sıkma Vidası
Screw
Klemmschraube

Pul
Stamp
Ring

Anahtar
Allen Key
Innensechskantschlüssel

AAKT-WGX24-R-L-2525-58-100-6-T32
AAKT-WGX24-R-L-2525-88-180-6-T32

R L

HF=H

B

LF

WF

CDX

DAXIN

DAXX

GX24-6

2004-M8x1x20

-

AAL-05-4

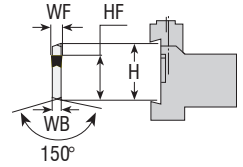
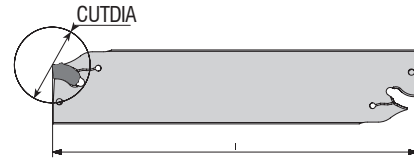
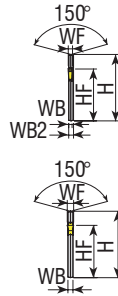

Takım Kodu
Ordering Code
Bestell-Bezeichnung

Stok
Stock
Lager

Takım Ölçüleri (mm)
Dimension (mm)
Abmessung (mm)

Kesici Uç
Insert
Wendeschneidplatte

Yedek Parçaları / Spare Parts
Ersatzteile

Anahtar
Allen Key
Innensechskantschlüssel

AKL-SX-32-3
AKL-SX-32-4
AKL-SX-32-5
AKL-SX-32-6

H

WF

WB2

WB

I

HF

CUTDIA

Fig.

SX-3E.300N

SX-4E.400N

SX-5E.500N

SX-5E.600N

ALA-04

R: Sağ / Right / Rechts L: Sol / Left / Links

● Stokta / In Stock / Auf Lager ○ Stokta Yok / Non Stock Item / Kein Lagerartikel, Lieferzeit auf Anfrage

Blok bilgileri için sayfa 155'ye gidin. / For block information, go to page 155. / Informationen zu den spannblock finden Sie auf Seite 155.

WLTR Ucuna Uygundur. / Compatible with WLTR Insert. / Kompatibel mit WLTR Wendeplatte.

Sipariş Örneği/Ordering Example/Bestellbeispiel
1 ad./pcs./stück AAKT-WGX24-R-2525-58-100-6-T32

XTC-GSC Ucuna Uygundur. / Compatible with **XTC-GSC** Insert. / Kompatibel mit **XTC-GSC** Wendeplatten.

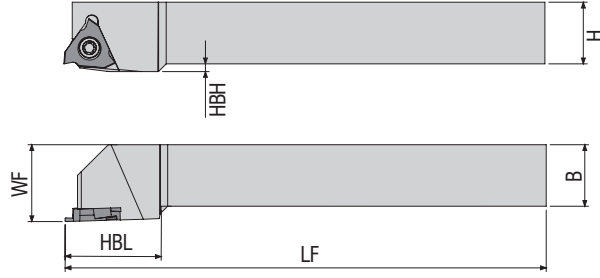

Takım Kodu Ordering Code Bestell-Bezeichnung	Stok Stock Lager		Takım Ölçüleri (mm) Dimension (mm) Abmessung (mm)				Kesici Uç Insert Wendeschneidplatte	Yedek Parçaları / Spare Parts / Ersatzteile			
	R	L	HF=H	B	LF	WF		Sıkma Vidası Screw Klemmschraube	Pul Stamp Ring	Tork Anahtar Torx Key Torx Innensechskantschlüssel	
ADKT-GB-R/L-1212-3	●	○	12	12	100	16	GB3100	4015-M3.5x10	-	80-T15	
ADKT-GB-R/L-1616-3	●	○	16	16	125	20					
ADKT-GB-R/L-2020-3	●	○	20	20	125	25					

XTC-GSC Ucuna Uygundur. / Compatible with **XTC-GSC** Insert. / Kompatibel mit **XTC-GSC** Wendeplatten.

ZCC Ucuna Uygundur. / Compatible with **ZCC** Insert. / Kompatibel mit **ZCC** Wendeplatten.

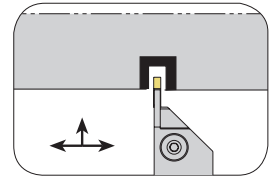
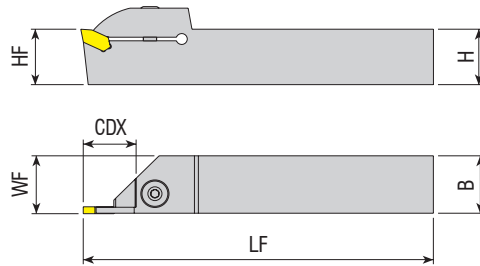

Takım Kodu Ordering Code Bestell-Bezeichnung	Stok Stock Lager		Takım Ölçüleri (mm) Dimension (mm) Abmessung (mm)				Kesici Uç Insert Wendeschneidplatte	Yedek Parçaları / Spare Parts / Ersatzteile			
	R	L	HF=H	B	LF	WF		CDX	Sıkma Vidası Screw Klemmschraube	Pul Stamp Ring	Anahtar Allen Key Innensechskantschlüssel
ADKT-ZCC1-R/L-2020-3-T20	●	○	20	20	125	20.3	20	ZQMX - 3	2004-M8x1x20	-	AAL-05-4
ADKT-ZCC1-R/L-2525-3-T22	●	○	25	25	150	25.3	22				
ADKT-ZCC1-R/L-2020-4-T20	●	○	20	20	125	20.4	20	ZQMX - 4	-	-	-
ADKT-ZCC1-R/L-2525-4-T22	●	○	25	25	150	25.4	22				

R: Sağ / Right / Rechts L: Sol / Left / Links

● Stokta / In Stock / Auf Lager ○ Stokta Yok / Non Stock Item / Kein Lagerartikel, Lieferzeit auf Anfrage

ZCC Ucuna Uygundur. / Compatible with **ZCC** Insert. / Kompatibel mit **ZCC** Wendeplatten.

Sipariş Örneği/Ordering Example/Bestellbeispiel

1 ad./pcs./stück ADKT-GB-R-1212-3

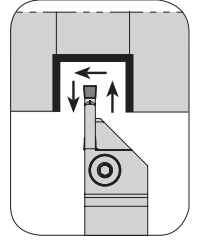
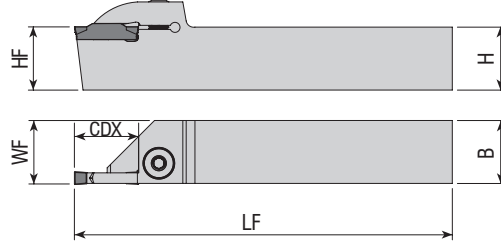

Takım Kodu
Ordering Code
Bestell-Bezeichnung

Stok
Stock
Lager

Takım Ölçüleri (mm)
Dimension (mm)
Abmessung (mm)

Kesici Uç
Insert
Wendeschneidplatte

Yedek Parçaları / Spare Parts / Ersatzteile

Sıkma Vidası
Screw
Klemmschraube

Pul
Stamp
Ring

Anahtar
Allen Key
Innensechskantschlüssel

R	L	HF=H	B	LF	WF	CDX	Kesici Uç Insert Wendeschneidplatte	Sıkma Vidası Screw Klemmschraube	Pul Stamp Ring	Anahtar Allen Key Innensechskantschlüssel	
ADKT-ZCC2-R/L-1616-2-T15	●	●	16	16	125	16.2	15	Z.BD - 2	AKV-02-M6x22	ABPL-01	AAL-03-3
ADKT-ZCC2-R/L-2020-2-T17	●	●	20	20	125	20.2	7				
ADKT-ZCC2-R/L-2020-2-T15	●	●	20	20	125	20.2	15				
ADKT-ZCC2-R/L-2525-2-T15	●	●	25	25	150	25.2	15	Z.ED - 2.5			
ADKT-ZCC2-R/L-1616-2.5-T15	●	●	16	16	125	16.3	15				
ADKT-ZCC2-R/L-2020-2.5-T17	●	●	20	20	125	20.3	17				
ADKT-ZCC2-R/L-2525-2.5-T15	●	●	25	25	150	25.3	15	Z.FD - 3			
ADKT-ZCC2-R/L-1616-3-T15	●	●	16	16	125	16.3	15				
ADKT-ZCC2-R/L-1616-3-T17	●	○	16	16	125	16.3	17				
ADKT-ZCC2-R/L-1616-3-T20	●	○	16	16	125	16.3	20	Z.GD - 4	2004-M8x1x20	-	AAL-05-4
ADKT-ZCC2-R/L-2020-3-T12	●	●	20	20	125	20.3	12				
ADKT-ZCC2-R/L-2020-3-T20	●	●	20	20	125	20.3	20				
ADKT-ZCC2-R/L-2020-3-R21	●	○	20	20	125	20.3	21	Z.HD - 5			
ADKT-ZCC2-R/L-2020-3-R25	●	●	20	20	125	20.3	25				
ADKT-ZCC2-R/L-2525-3-T12	●	○	25	25	150	25.3	12				
ADKT-ZCC2-R/L-2525-3-T22	●	●	25	25	150	25.3	22	Z.KD - 6			
ADKT-ZCC2-R/L-2525-3-R30	●	●	25	25	150	25.3	30				
ADKT-ZCC2-R/L-2020-4-T12	●	○	20	20	125	20.5	12				
ADKT-ZCC2-R/L-2020-4-T20	●	●	20	20	125	20.5	20	Z.HD - 5			
ADKT-ZCC2-R/L-2525-4-T12	●	●	25	25	150	25.5	12				
ADKT-ZCC2-R/L-2525-4-T22	●	●	25	25	150	25.5	22				
ADKT-ZCC2-R/L-2020-5-T12	●	○	20	20	125	20.5	12	Z.KD - 6			
ADKT-ZCC2-R/L-2020-5-T20	●	●	20	20	125	20.5	20				
ADKT-ZCC2-R/L-2525-5-T12	●	○	25	25	150	25.5	12				
ADKT-ZCC2-R/L-2525-5-T25	●	●	25	25	150	25.5	25	Z.KD - 6			
ADKT-ZCC2-R/L-3232-5-T25	●	●	32	32	170	32.5	25				
ADKT-ZCC2-R/L-2020-6-T20	●	●	20	20	125	20.6	20				
ADKT-ZCC2-R/L-2525-6-T25	●	●	25	25	150	25.6	25	Z.KD - 6			
ADKT-ZCC2-R/L-3232-6-T25	●	●	32	32	170	32.6	25				
ADKT-ZCC2-R/L-3232-6-T30	●	●	32	32	170	32.6	30				

R: Sağ / Right / Rechts L: Sol / Left / Links

● Stokta / In Stock / Auf Lager ○ Stokta Yok / Non Stock Item / Kein Lagerartikel, Lieferzeit auf Anfrage

ZCC Ucuna Uygundur. / Compatible with ZCC Insert. / Kompatibel mit ZCC Wendeplatten.

Sipariş Örneği/Ordering Example/Bestellbeispiel

1 ad./pcs./stück ADKT-ZCC2-R-1616-2-T15

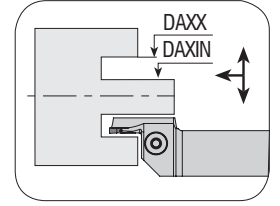
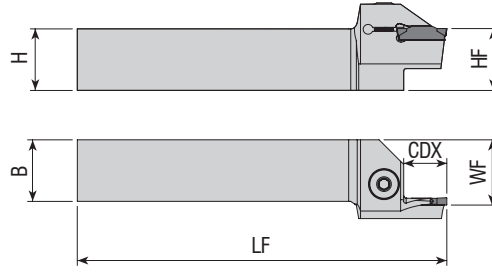

Takım Kodu Ordering Code Bestell-Bezeichnung	Takım Ölçüleri (mm) Dimension (mm) Abmessung (mm)									Kesici Uç Insert Wendeschneidplatte	Yedek Parçaları / Spare Parts / Ersatzteile		
	R	L	HF=H	B	LF	WF	CDX	DAXIN	DAXX		Sıkma Vidası Screw Klemmschraube	Pul Stamp Ring	Anahtar Allen Key Innensechskantschlüssel
AAKT-ZCC2-R/L-2525-140-180-2-T4	●	○	25	25	150	26.5	4	140	180	Z.BD - 2	2004-M8x1x20	-	AAL-05-4
AAKT-ZCC2-R/L-2525-35-45-3-T17	●	●	25	25	150	26.5	17	35	45	Z.FD - 3			
AAKT-ZCC2-R/L-2525-39-55-3-T17	●	○	25	25	150	26.5	17	39	55				
AAKT-ZCC2-R/L-2525-49-80-3-T17	●	●	25	25	150	26.5	17	49	80				
AAKT-ZCC2-R/L-2525-70-110-3-T15	●	○	25	25	150	26.5	15	70	110				
AAKT-ZCC2-R/L-2525-70-110-3-T17	●	●	25	25	150	26.5	17	70	110				
AAKT-ZCC2-R/L-2525-100-150-3-T17	●	●	25	25	150	26.5	17	100	150				
AAKT-ZCC2-R/L-2525-100-150-3-T22	●	●	25	25	150	26.5	22	100	150				
new AAKT-ZCC2-R/L-3232-135-175-3-T5	●	○	32	32	170	33.5	5	135	175	Z.HD-3			
new AAKT-ZCC2-R/L-3232-145-175-3-T15	●	○	32	32	170	33.5	15	145	175				
new AAKT-ZCC2-R/L-3232-155-185-3-T7	●	○	32	32	170	33.5	7	155	185				
new AAKT-ZCC2-R/L-3232-180-215-3-T5	●	○	32	32	170	33.5	5	180	215				
AAKT-ZCC2-R/L-2525-40-60-4-T22	●	○	25	25	150	26.5	22	40	60	Z.GD - 4			
AAKT-ZCC2-R/L-2525-52-80-4-T22	●	●	25	25	150	26.5	22	52	80				
AAKT-ZCC2-R/L-2525-72-110-4-T22	●	●	25	25	150	26.5	22	72	110				
AAKT-ZCC2-R/L-2525-100-150-4-T22	●	●	25	25	150	26.5	22	100	150				
AAKT-ZCC2-R/L-2525-140-200-4-T22	●	●	25	25	150	26.5	22	140	200				
new AAKT-ZCC2-R/L-3232-130-195-4-T10	●	○	32	32	170	33.5	10	130	195	Z.HD-4			
AAKT-ZCC2-R/L-2525-55-95-5-T25	●	○	25	25	150	26.5	25	55	95	Z.HD - 5			
AAKT-ZCC2-R/L-2525-85-140-5-T25	●	●	25	25	150	26.5	25	85	140				
new AAKT-ZCC2-R/L-2525-100-200-5-T45	●	○	25	25	150	26.5	45	100	200				
AAKT-ZCC2-R/L-2525-130-200-5-T25	●	●	25	25	150	26.5	25	130	200				
AAKT-ZCC2-R/L-2525-190-400-5-T25	●	○	25	25	150	26.5	25	190	400				
AAKT-ZCC2-R/L-2525-190-400-5-T35	●	○	25	25	150	26.5	35	190	400				
new AAKT-ZCC2-R/L-3232-150-215-5-T10	●	○	32	32	170	33.5	10	150	215				
AAKT-ZCC2-R/L-2525-200-500-5-T17	●	●	25	25	150	26.5	17	200	500	Z.KD - 6			
AAKT-ZCC2-R/L-2525-60-110-6-T15	●	○	25	25	150	26.5	15	60	110				
AAKT-ZCC2-R/L-3232-160-400-6-T25	○	●	32	32	170	33.5	25	160	400				

R: Sağ / Right / Rechts L: Sol / Left / Links

● Stokta / In Stock / Auf Lager ○ Stokta Yok / Non Stock Item / Kein Lagerartikel, Lieferzeit auf Anfrage

ZCC Ucuna Uygundur. / Compatible with ZCC Insert. / Kompatibel mit ZCC Wendeplatten.

Sipariş Örneği/Ordering Example/Bestellbeispiel
1 ad./pcs./stück AAKT-ZCC2-R-2525-140-180-2-T4

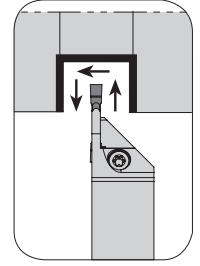
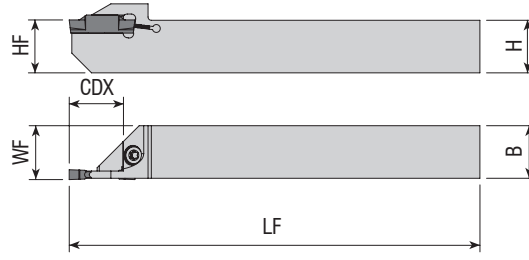

Takım Kodu Ordering Code Bestell-Bezeichnung	Stok Stock Lager		Takım Ölçüleri (mm) Dimension (mm) Abmessung (mm)				Kesici Uç Insert Wendeschneidplatte	Yedek Parçaları / Spare Parts / Ersatzteile			
	R	L	HF=H	B	LF	WF		CDX	Sıkma Vidası Screw Klemmschraube	Pul Stamp Ring	Tork Anahtar Torx Key Torx Innensechskantschlüssel
ADKT-ZCC2-R/L-1010-2-T12-K-S	●	●	10	10	125	10.2	12	Z.BD - 2	4015-M4x11	-	80-T15
ADKT-ZCC2-R/L-1212-2-T12-K-S	●	●	12	12	125	12.2	12				
ADKT-ZCC2-R/L-1616-2-R16-K-S	●	●	16	16	125	16.2	16	Z.FD - 3			
ADKT-ZCC2-R/L-1212-3-T12-K-S	●	●	12	12	125	12.3	12				

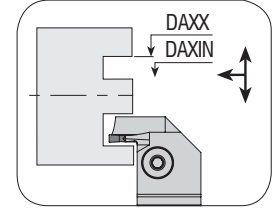
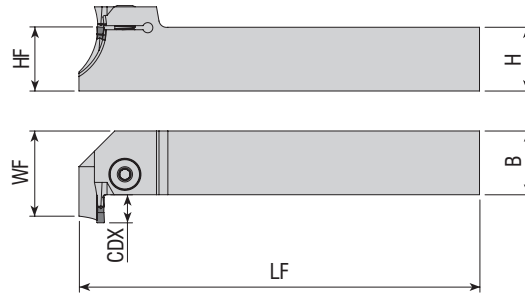

Takım Kodu Ordering Code Bestell-Bezeichnung	Stok Stock Lager		Takım Ölçüleri (mm) Dimension (mm) Abmessung (mm)							Kesici Uç Insert Wendeschneidplatte	Yedek Parçaları / Spare Parts / Ersatzteile		
	R	L	HF=H	B	LF	WF	CDX	DAXIN	DAXX		Sıkma Vidası Screw Klemmschraube	Pul Stamp Ring	Anahtar Allen Key Innensechskantschlüssel
ALKT-ZCC2-R/L-2525-35-45-3-T10	●	●	25	25	150	36	10	35	45	Z.FD - 3	2004-M8x1x20	-	AAL-05-4
ALKT-ZCC2-R/L-2525-39-55-3-T10	●	●	25	25	150	36	10	39	55				
ALKT-ZCC2-R/L-2525-35-∞-3-T4	●	●	25	25	150	30	4	35	∞	Z.GD - 4			
ALKT-ZCC2-R/L-2525-40-60-4-T14	●	●	25	25	150	40	14	40	60				
ALKT-ZCC2-R/L-2525-52-80-4-T14	●	○	25	25	150	40	14	52	80	Z.GD - 4			
ALKT-ZCC2-R/L-2525-72-110-4-T14	●	○	25	25	150	40	14	72	110				
ALKT-ZCC2-R/L-2525-100-230-4-T14	●	●	25	25	150	40	14	100	230	Z.GD - 4			
ALKT-ZCC2-R/L-2525-40-∞-4-T4	●	●	25	25	150	30	4	40	∞				

R: Sağ / Right / Rechts L: Sol / Left / Links

● Stokta / In Stock / Auf Lager ○ Stokta Yok / Non Stock Item / Kein Lagerartikel, Lieferzeit auf Anfrage

ZCC Ucuna Uygundur. / Compatible with ZCC Insert. / Kompatibel mit ZCC Wendeplatten.

Sipariş Örneği/Ordering Example/Bestellbeispiel
1 ad./pcs./stück ADKT-ZCC2-R-1010-2-T12-K-S

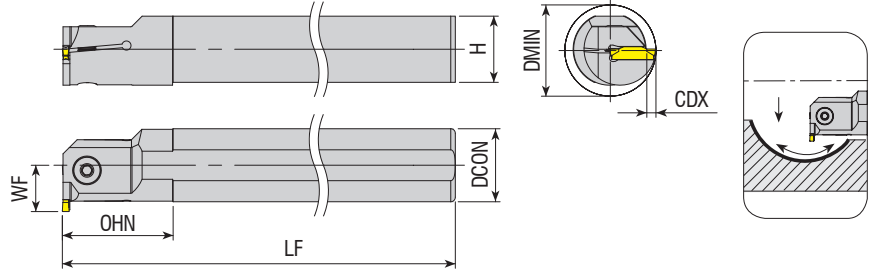

Takım Kodu Ordering Code Bestell-Bezeichnung	Stok Stock Lager		Takım Ölçüleri (mm) Dimension (mm) Abmessung (mm)						Kesici Uç Insert Wendeschneidplatte	Yedek Parçaları / Spare Parts / Ersatzteile		
	R	L	DCON	DMIN	LF	OHN	CDX	H	WF	Sıkma Vidası Screw Klemmschraube	Anahtar Allen Key Innensechskantschlüssel	
AIKT-ZCC2-R/L-16-2-T4	●	○	16	21	150	28	4	14.8	12	Z.BD - 2	2503-M4x10	AAL-03-3
AIKT-ZCC2-R/L-20-3-T5	●	●	20	27	170	30	5	18.3	15	Z.FD - 3	2504-M5x12	AAL-05-4
AIKT-ZCC2-R/L-20-3-T8	●	○	20	29	170	30	8	18.3	18		2504-M5x16	
AIKT-ZCC2-R/L-25-3-T5	●	○	25	31	200	40	5	23	17.5		2504-M5x16	
AIKT-ZCC2-R/L-25-3-T10	●	○	25	36	200	40	10	23	22.5		2504-M5x16	
AIKT-ZCC2-R/L-32-3-T6	●	○	32	39	250	50	6	30	22	Z.GD - 4	2004-M8x1x20	AAL-05-4
AIKT-ZCC2-R/L-32-3-T8	●	○	32	41	250	50	8	30	24			
AIKT-ZCC2-R/L-32-3-T13	●	○	32	46	250	50	13	30	29			
AIKT-ZCC2-R/L-40-3-T12	●	○	40	53	300	55	12	37.5	32			
AIKT-ZCC2-R/L-25-4-T6	●	○	25	32	200	40	6	23	18.5	Z.HD - 5	2504-M5x16	AAL-05-4
AIKT-ZCC2-R/L-32-4-T7	●	○	32	40	250	50	7	30	23			
AIKT-ZCC2-R/L-32-4-T8	●	○	32	41	250	50	8	30	24			
AIKT-ZCC2-R/L-32-4-T10	●	○	32	43	250	50	10	30	26			
AIKT-ZCC2-R/L-32-5-T7	●	○	32	40	250	50	7	30	23	2004-M8x1x20	AAL-05-4	
AIKT-ZCC2-R/L-32-5-T8	●	○	32	41	250	50	8	30	24			
AIKT-ZCC2-R/L-40-5-T8	●	○	40	49	300	55	8	37.5	28			
AIKT-ZCC2-R/L-40-5-T10	●	○	40	51	300	55	10	37.5	30			

R: Sağ / Right / Rechts L: Sol / Left / Links

● Stokta / In Stock / Auf Lager ○ Stokta Yok / Non Stock Item / Kein Lagerartikel, Lieferzeit auf Anfrage

ZCC Ucuna Uygundur. / Compatible with ZCC Insert. / Kompatibel mit ZCC Wendeplatten.

Sipariş Örneği/Ordering Example/Bestellbeispiel

1 ad./pcs./stück AIKT-ZCC2-R/L-16-2-T4

ZCC Ucuna Uygundur. / Compatible with ZCC Insert. / Kompatibel mit ZCC Wendeplatten.

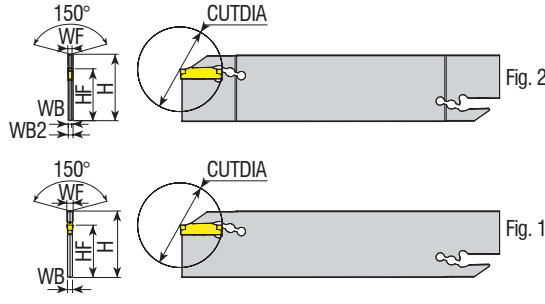
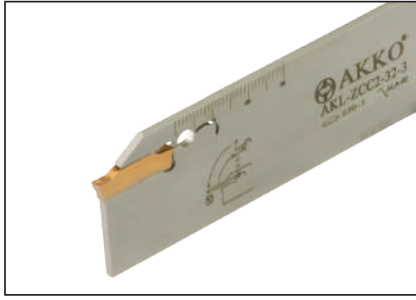

Takım Kodu Ordering Code Bestell-Bezeichnung	Stok Stock Lager		Takım Ölçüleri (mm) Dimension (mm) Abmessung (mm)							Kesici Uç Insert Wendeschneidplatte	Yedek Parçaları / Spare Parts Ersatzteile	
			H	WF	WB2	WB	l	HF	CUTDIA	Fig.		Anahtar Allen Key Innensechskantschlüssel
AKL-ZCC2-32-3	●		32	3	-	2.40	150	25	39	1	Z.FD-3	ALA-02
AKL-ZCC2-32-4	●		32	4	-	3.20	150	25	50.8	1	Z.FD-4	
AKL-ZCC2-32-5	●		32	5	-	4	150	25	50.8	1	Z.FD-5	

Blok bilgileri için sayfa 155'ye gidin. / For block information, go to page 155. / Informationen zu den spannblock finden Sie auf Seite 155.

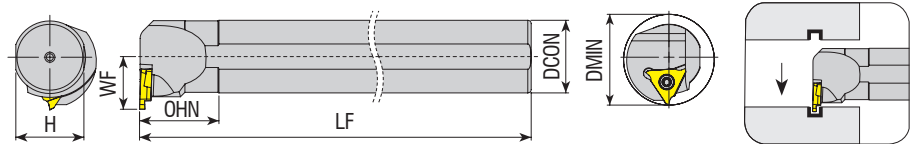

Takım Kodu Ordering Code Bestell-Bezeichnung	Stok Stock Lager		Takım Ölçüleri (mm) Dimension (mm) Abmessung (mm)							Kesici Uç Insert Wendeschneidplatte	Yedek Parçaları / Spare Parts / Ersatzteile	
	R	L	DCON	DMIN	LF	OHN	CDX	H	WF		Sıkma Vidası Screw Klemmschraube	Tork Anahtar Torx Key Torx Innensechskantschlüssel
AIKT-QC11-R/L-20-(0.5-1.8)	●	○	20	16	150	40	-	18.3	11.1	QC11R/L (0.50-1.80)	3008 M2.5x6	82-T08
AIKT-QC16-R/L-20-(0.5-1.8)	○	○	20	25	150	35	-	18.3	13.5	QC16R/L (0.50-1.80)	4015-M3.5x10	80-T15
AIKT-QC16-R/L-20-(0.5-2.5)	●	○	20	25	150	35	-	18.3	13.5	QC16R/L (0.50-2.50)		
AIKT-QC22-R/L-25-(1-2.3)	○	○	25	35	150	35	-	23	18.2	QC22R/L (1.00-2.30)		
AIKT-QC22-R/L-25-(2.5-3.3)	●	○	25	35	150	35	-	23	18.2	QC22R/L (2.50-3.30)	1020 M5x11	80-T20
AIKT-QC22-R/L-25-(3.3-4.8)	●	○	25	35	150	35	-	23	18.2	QC22R/L (3.30-4.80)		
AIKT-QC22-R/L-32-(1-2.3)	○	○	32	45	150	35	-	30	23.2	QC22R/L (1.00-2.30)		

R: Sağ / Right / Rechts L: Sol / Left / Links

● Stokta / In Stock / Auf Lager ○ Stokta Yok / Non Stock Item / Kein Lagerartikel, Lieferzeit auf Anfrage

ZCC Ucuna Uygundur. / Compatible with ZCC Insert. / Kompatibel mit ZCC Wendeplatten.

Sipariş Örneği/Ordering Example/Bestellbeispiel

1 ad./pcs./stück AKL-ZCC2-32-3

konusulan
the spoken kalite...
quality...



DELİK DELME ve İŞLEME TAKIMLARI
DRILLING and HOLEMAKING TOOLS
BOHRWERKZEUGE





*konusulan
the spoken kalite...
quality...*

U-DRILL

TAKMA UÇLU MATKAPLAR
U-DRILL SYSTEM
VOLLBOHRER





AKKO **A** **TUM** **16** x **D3**

S **P** **G** **T** **06** **02** **04**

2 Kesici Stili / Cutter Style
Werkzeugtyp

TUM: Takma Uçlu Matkap
U-Drill
Vollbohrer

3 Takım Çapı / Tool Diameter /
Werkzeughdurchmesser

4 Delme Derinliği / Drilling Depth /
Bohrtiefe

5 Uç Şekli / Insert Form
Plattenform

W **S**

8 Uç Tipi / Insert Type
Plattentyp

A $\beta = 70-90^\circ$ J $\beta = 70-90^\circ$ T $\beta = 40-60^\circ$
 B $\beta = 70-90^\circ$ M $\beta = 40-60^\circ$ U $\beta = 40-60^\circ$
 C $\beta = 70-90^\circ$ N $\beta = 40-60^\circ$ W $\beta = 40-60^\circ$
 F $\beta = 70-90^\circ$ Q $\beta = 40-60^\circ$
 G $\beta = 70-90^\circ$ R $\beta = 40-60^\circ$ X Özel Sonder
 H $\beta = 70-90^\circ$

10 Kalınlık / Thickness
Dicke

01 s = 1.59
 T1 s = 1.98
 02 s = 2.38
 T2 s = 2.78
 03 s = 3.18
 T3 s = 3.97
 04 s = 4.76
 05 s = 5.56
 06 s = 6.35
 07 s = 7.94
 09 s = 9.52

6 Serbest Uç Açısı / Clearance angle of Insert
Freiwinkel der Wendeschneidplatte

C **P**

7 Toleranslar / Tolerance Classes / Toleranzen

	IC	M	S
A	± 0.025	± 0.005	± 0.025
C	± 0.025	± 0.013	± 0.025
E	± 0.025	± 0.025	± 0.025
F	± 0.013	± 0.005	± 0.025
G	± 0.025	± 0.025	± 0.130
H	± 0.013	± 0.013	± 0.025
J	± 0.05-0.15	± 0.005	± 0.025
K	± 0.05-0.15	± 0.013	± 0.025
L	± 0.05-0.15	± 0.025	± 0.025
M	± 0.05-0.15	± 0.08-0.20	± 0.130
N	± 0.05-0.15	± 0.08-0.20	± 0.025
U	± 0.08-0.25	± 0.13-0.38	± 0.130

IC : Daire Ölçüsü / Inscribed Circle / Kreisgröße
 M : Şekle Göre / Refer to Figure / Siehe Abbildung
 S : Kalınlık / Thickness / Dicke

9 Kesme Kenar Uzunluğu / Cutting Edge Length
Schneidkantenlänge

11 Köşe Konfigurasyonu / Corner Radius
Eckenradius

01 r = 0.1
 02 r = 0.2
 04 r = 0.4
 08 r = 0.8
 12 r = 1.2
 16 r = 1.6
 24 r = 2.4

HELİSEL İÇTEN SU VERME KANALLI MATKAPLAR

INDEXABLE DRILLS WITH HELICAL COOLANT HOLE

INDIZIERBARE VOLLBOHRER MIT HELIX KÜHLUNGSHÖHLEN

Farklı çaplarda ve ALFA KAPLAMA teknolojisi ile siparişe hazır.

They are ready to order in different diameters and with ALPHA COATING technology.

Die Vollbohrer sind in unterschiedlichen Dimensionen und mit ALFABESCHICHTUNGSTECHNOLOGIE bereit für die Bestellungen.

- Helisel içten su verme kanallı
- Üstün Alpha Kaplama Teknolojisi
- 1000 Vickers'e dayanan yüksek yüzey sertliği
- Aşınmaya karşı yüksek direnç
- Dengeli ve hassas kesim
- Helical Internal Coolant Holes
- Superior Alpha Coating Technology
- High surface hardness up to 1000 Vickers
- High resistance to abrasion
- Balanced and precise cutting
- Helix ininterne Kühlungshöhlen
- Überragende Alphabeschichtungsstechnologie
- Hohe Oberflächen Härte bis zu 1000 Vickers.
- Hoher Widerstand gegen Abnutzung
- Ausgewogene und präzise Bearbeitung

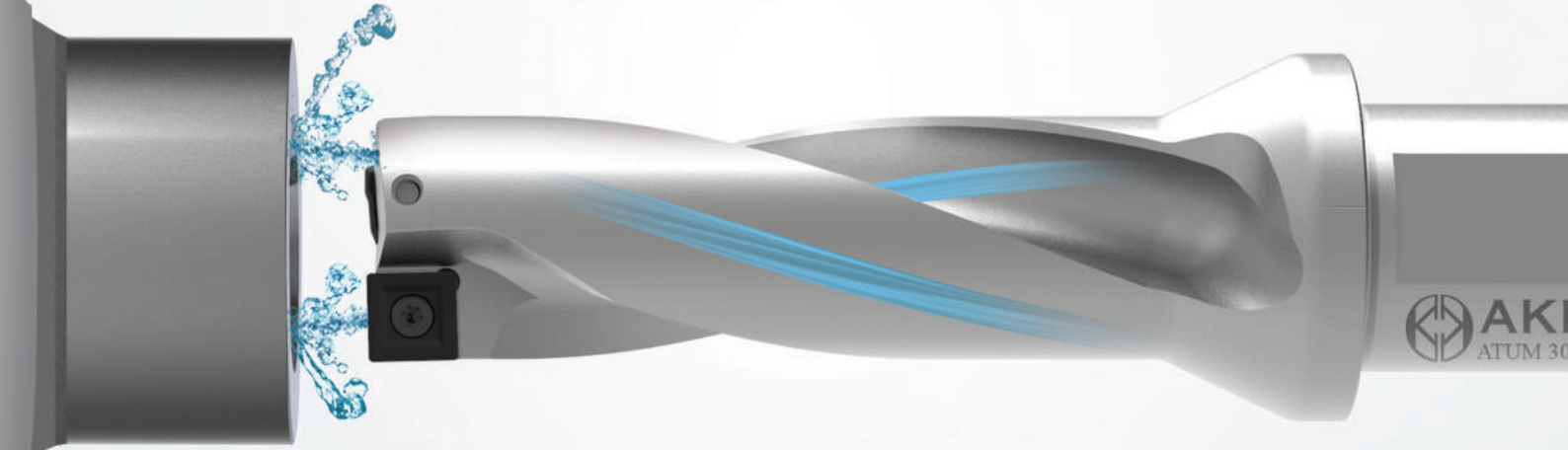

AKKO HELİSEL KANAL TEKNOLOJİSİ
AKKO HELICAL CHANNEL TECHNOLOGY
AKKO HELIX KANAL TECHNOLOGIE

RAKİPLER
COMPETITORS
KONKURRENZ



* STOK DURUMU / STOCK STATUS / STOCK STATUS

D2 / D3 / D4 / D5

* Helisel İçten Su Verme Kanallı
Twisted Coolant Hole
Spiralförmige Kühlungshöhlen

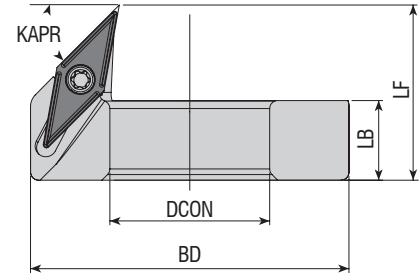

Takım Kodu Ordering Code Bestell-Bezeichnung	Stok Stock Lager	Takım Ölçüleri (mm) Dimension (mm) Abmessung (mm)				Kullanılacak ATUM Ölçüsü Compatible ATUM Diameter Verwendeter Vollbohrer	Yedek Parçaları / Spare Parts / Ersatzteile				
		BD	DCON	LB	LF		ATUM Ø	Kesici Uç Insert Wendeschneidplatte	Sıkma Vidası Screw Schraube	Tork Anahtar Torx Key Torx-Schlüssel	Montaj Vidası Mounting Screw Befestigungsschraube
ADCR-120-VB1103	●	32	12	10	22	12.5	VB.T 1103..	4008-M2.5x6	82-T08	AAV-14-M5x14	AAL-03-3
ADCR-125-VB1103	●	32.5	12.5	10	22	13					
ADCR-130-VB1103	●	33	13	10	22	13.5					
ADCR-135-VB1103	●	33.5	13.5	10	22	14					
ADCR-140-VB1103	●	34	14	10	22	14.5					
ADCR-145-VB1103	●	34.5	14.5	10	22	15					
ADCR-150-VB1103	●	35	15	10	22	15.5 -16					
ADCR-155-VB1103	●	35.5	15.5	10	22	16.5					
ADCR-160-VB1103	●	36	16	10	22	17					
ADCR-165-VB1103	●	36.5	16.5	10	22	17.5					
ADCR-170-VB1103	●	37	17	10	22	18					
ADCR-175-VB1103	●	37.5	17.5	10	22	18.5					
ADCR-180-VB1103	●	38	18	10	22	19					
ADCR-185-VB1103	●	38.5	18.5	10	22	19.5					
ADCR-190-VB1103	●	39	19	10	22	20					
ADCR-195-VB1103	●	39.5	19.5	10	22	20.5					
ADCR-200-VB1103	●	40	20	10	22	21					
ADCR-205-VB1103	●	40.5	20.5	10	22	21.5					
ADCR-210-VB1103	●	41	21	10	22	22					
ADCR-215-VB1103	●	41.5	21.5	10	22	22.5					
ADCR-220-VB1103	●	42	22	10	22	23					
ADCR-225-VB1103	●	42.5	22.5	10	22	23.5					
ADCR-230-VB1103	●	43	23	10	22	24					
ADCR-235-VB1103	●	43.5	23.5	10	22	24.5					
ADCR-240-VB1103	●	44	24	10	22	25					
ADCR-245-VB1103	●	44.5	24.5	10	22	25.5					
ADCR-250-VB1103	●	45	25	10	22	26					
ADCR-255-VB1103	●	45.5	25.5	10	22	26.5					
ADCR-260-VB1103	●	46	26	10	22	27					
ADCR-265-VB1103	●	46.5	26.5	10	22	27.5					
ADCR-270-VB1103	●	47	27	10	22	28					
ADCR-275-VB1103	●	47.5	27.5	10	22	28.5					
ADCR-280-VB1103	●	48	28	10	22	29					
ADCR-285-VB1103	●	48.5	28.5	10	22	29.5					
ADCR-290-VB1103	●	49	29	10	22	30					
ADCR-295-VB1103	●	49.5	29.5	10	22	30.5					
ADCR-300-VB1103	●	50	30	10	22	31					

R: Sağ / Right / Rechts/ L: Sol / Left / Links

● Stokta / In Stock / Auf Lager ○ Stokta Yok / Non Stock Item / Kein Lagerartikel, Lieferzeit auf Anfrage

ISO Uçuna Uygundur. / Compatible with ISO Insert. / Kompatibel mit ISO Wendeplatten.

Sipariş Örneği/Ordering Example/Bestellbeispiel

1 ad./pcs./stück ADCR-120-VB1103

Delik Pahlama Bileziği Kullanım Kılavuzu : S 202 / User's Guide For Drill Chamfering Ring Tools : P 202

Technische Information Für Bohrer-Färsingwerkzeuge: P 202

Tavsiye Edilen / Recommended / Empfehlung

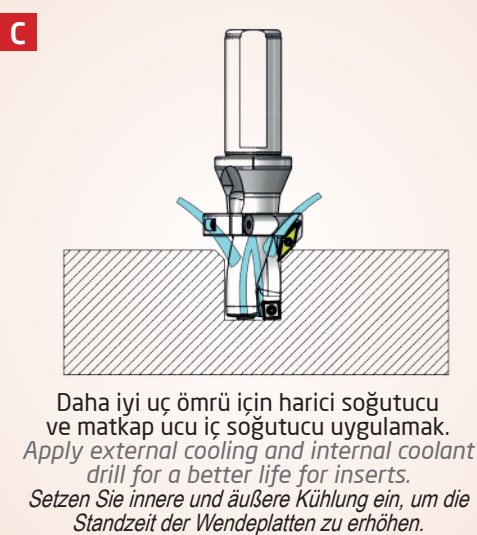
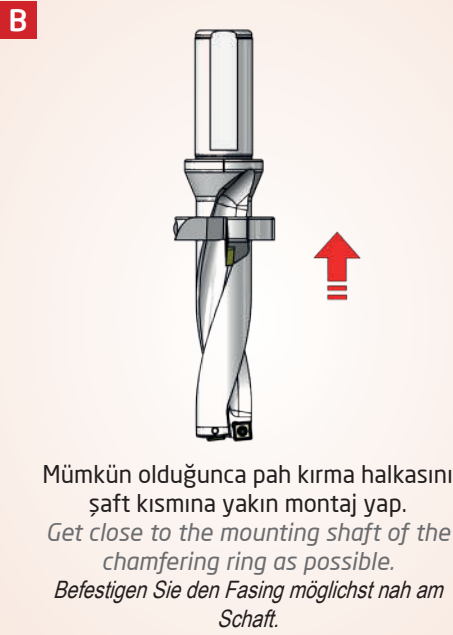
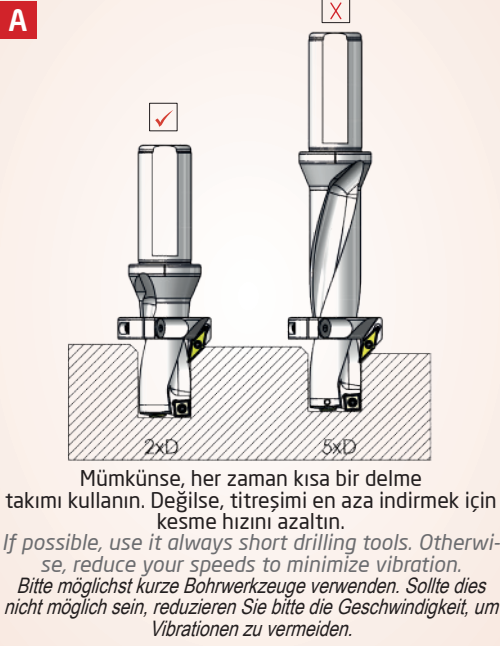

Montaj Şekli / Mounting System / Montage-Hinweise

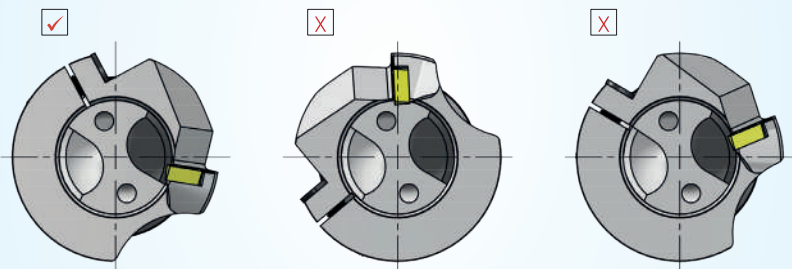
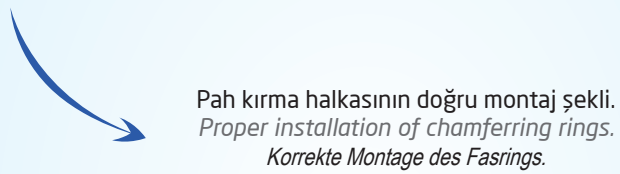
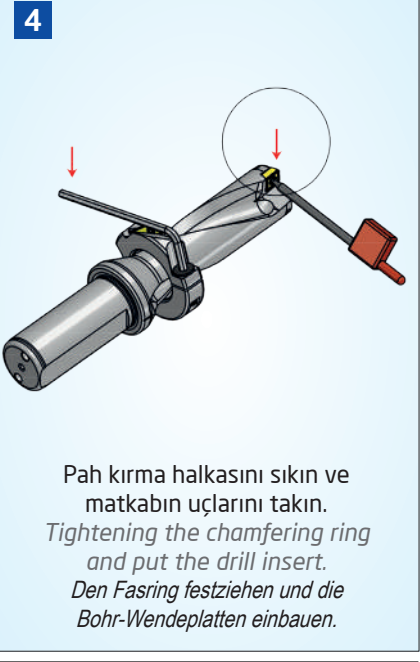

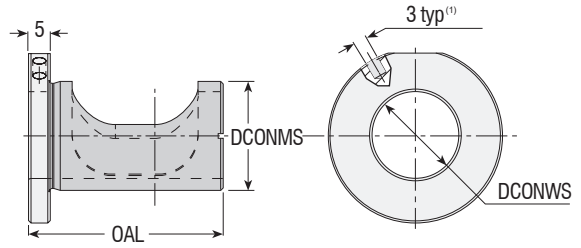

Takım Kodu Ordering Code Bestell-Bezeichnung	Stok Stock Lager	Takım Ölçüleri (mm) Dimension (mm) Abmessung (mm)		
		DCONWS	DCONMS	OAL
AET-2025	●	20	25	44
AET-2532	●	25	32	46
AET-3240	●	32	40	55

■⁽¹⁾ Delik ince bir metal yardımıyla adaptörün radyal olarak ayarlanmasını kolaylaştırmak için kullanılır. / Holes for inserting a pin, used to facilitate radial adjustment of the sleeve (pin not supplied).
 Bohrung zum Einsetzen eines Stiftes mit dem der Adapter radial eingestellt werden kann (Stift ist nicht im Lieferumfang enthalten).

Frezeleme tezgahında takma uçlu matkabın nominal çapı, matkabın ekseninin, spindle eksenine göre ötelenmesiyle değiştirilebilir.
 On a milling machine the drill's nominal diameter can be changed by shifting the drill's axis out of the tool spindle.
 Auf einer Fräsmaschine kann die Nennweite des Bohrers durch Verschieben der Bohrerachse aus der Spindelachse verändert werden..

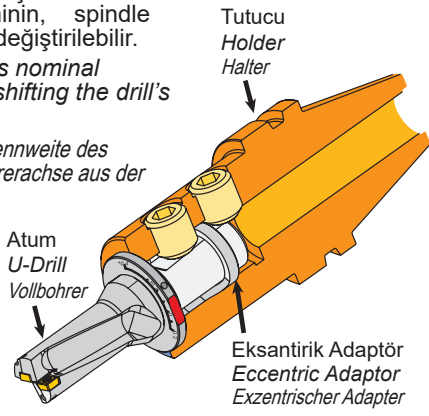

Radyal ayarlama pimi.
(Verilmeyecektir.)
 Radial adjustment pin. (not supplied)
 Radial - Einstellstift
(nicht im Lieferumfang)

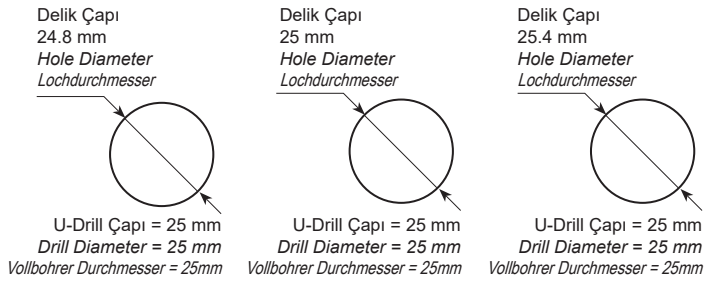
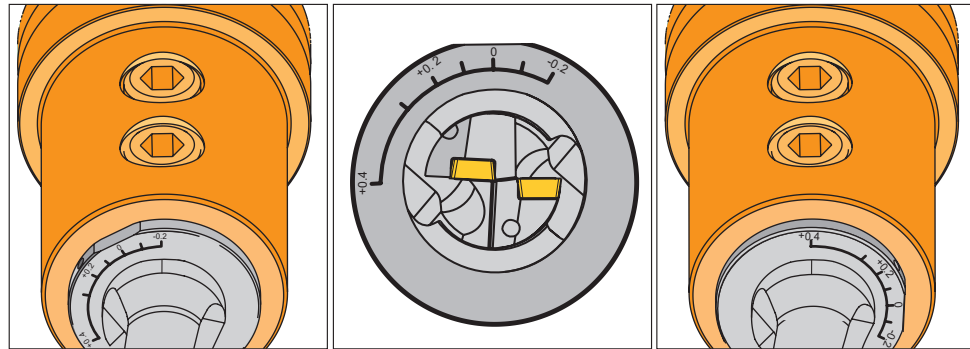
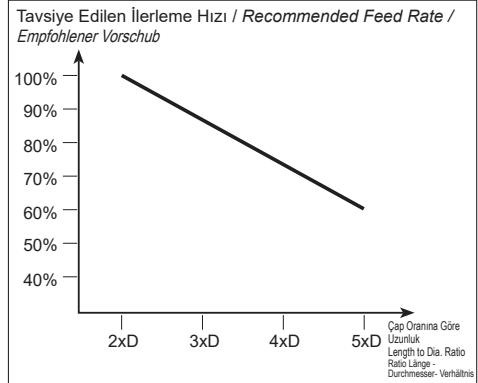
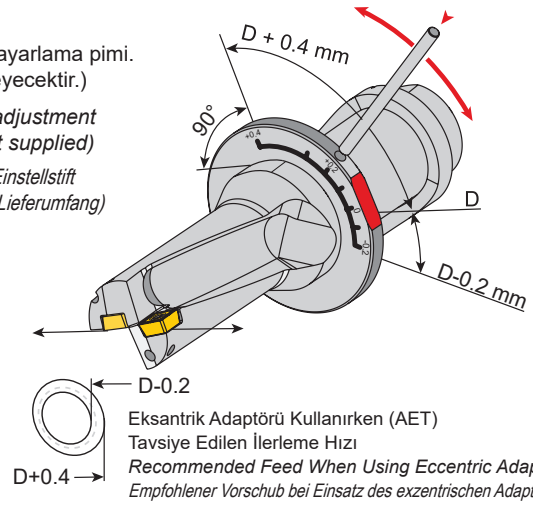

ATUM'un üzerindeki düz çizgi adaptörün sıfır rakamının üzerine konulmalıdır. AET'nin (eksantrik adaptörün) çevrilmesini kolaylaştırmak için AET'nin üzerindeki deliğe, metal bir çubuk ya da vida anahtarı yerleştirilebilir. AET'yi ayarlama önce tutucunun vidasını hafifçe çözün.
 The adjustment markings should be located perpendicular to the flat on the circumference of the U-DRILL flange.
 To facilitate the rotation of the adaptor, a metal rod or a screw key may be inserted into a hole on the excentric adaptor flange. Unlock adapter screw before adjusting adaptor.
 Die Einstellmarkierung sollte senkrecht zur Fläche des Bohrerschafes stehen. Zum Drehen des Adapters sollte ein Stift in die Bohrung am Adapterflansch eingesetzt werden. Lösen Sie die Adapter-Schraube vor dem Einstellen des Adapters.

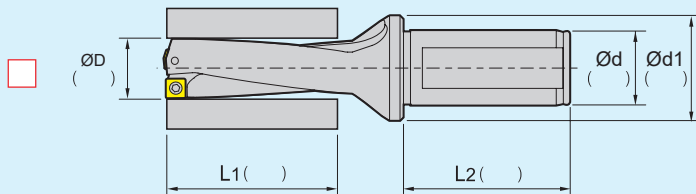
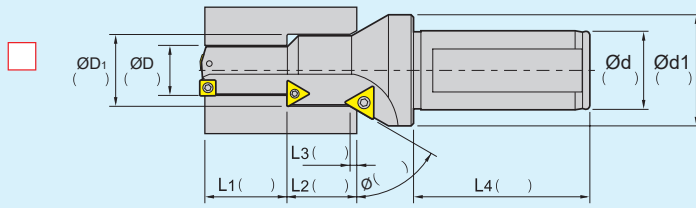
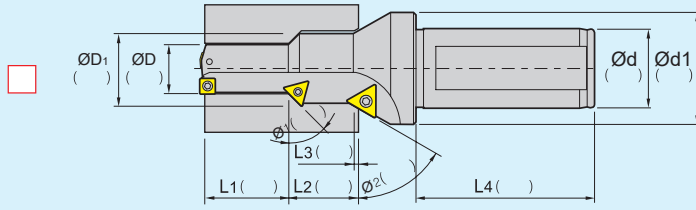
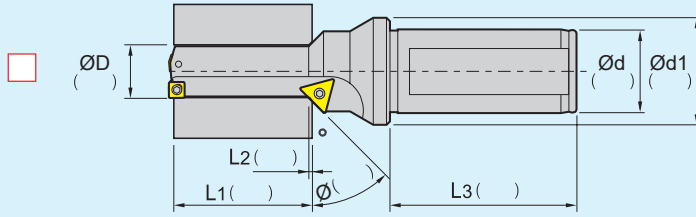
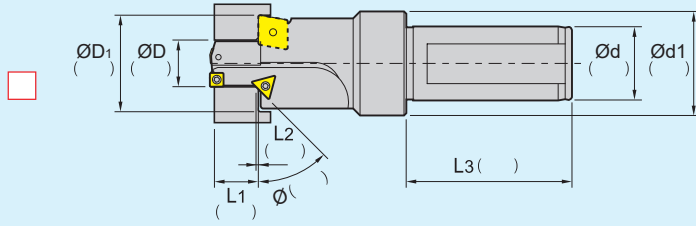

• Soğutma Tipi / Coolant type / Kühlmittelanschluss

- Yağ Deliği Dalma Kismında
Oil Hole On the Plunge Part
Kühlmittelzuführung über den Bund
- Yağ Deliği Şaft Kismında
"Oil hole On the Shank"
Kühlmittelbohrung durch den Schaft

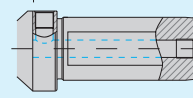

• Delik Tipi / Hole Type / Bohrungstyp

- Kapalı Delik
Blind Hole
Grundbohrung
- Açık Delik
Thru Hole
Durchgangsbohrung

• Şaft Tipleri / Types of Shank / Schaftausführung

- Düz Tip
Flat Type
Bohrungstyp
- Weldon Tip
Weldon Type
Weldon-Schaft
- Eğimli Yargı Tipi
Whistle Notch Type
Whistle-Notch-Schaft

• Yargı Bağlama Yeri / Location of Side Lock / Position der Spannfläche

- Dış Uca Parellel (Standart)
Parallel to Peripheral Insert (Standard)
Parallel zur äußeren Wendeplatte
- Dış Uca 90° Açılı
90° angle to peripheral insert
90° außen abgewinkelt
- Dış Uca 150° Açılı
150° angle to peripheral insert
150° außen abgewinkelt
- Dış Uca 180° Açılı
180° angle to peripheral insert
180° außen abgewinkelt

• Not / Note / Hinweis :

- Şu Anki Kullanılan Takım / Currently Using Tool
- Aktuell verwendetes Werkzeug
- Şu Anki Kesme Durumu / Current Cutting Condition
- Aktuelle Schnittbedingungen
- RPM ya da vc(m/min) / - RPM or vc(m/min)
- Umdrehungen pro Minute oder vc (m/min.)
- vf(mm/min) ya da fn(mm/rev)
- vf(mm/min) or fn(mm/rev) vf (mm/min.) oder fn (mm/Umdr.)
- Kesme Derinliği / Depth of Cut(mm)
- Schnitttiefe (mm)
- Ölçülen Standart Takım Ömrü / Standard of Measuring Tool Life
- Standzeit des Werkzeugs
- Şu Anki Kullanılan Makinalar / Currently Using Machine
- Aktuell eingesetzte Maschine
- İşleme Merkezi / Machining Center
- Bearbeitungszentrum
- Genel Torna / General Lathe
- Drehmaschine
- CNC Torna / CNC Lathe
- CNC-Drehmaschine



Delme Derinliği
Drilling Depth
Bohrtiefe

= 2x Çap
= 2x Diameter
= 2x Durchmesser

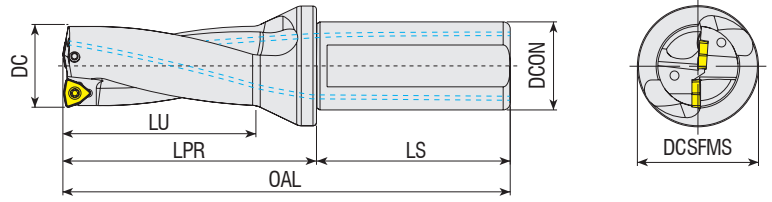

Takım Kodu Ordering Code Bestell-Bezeichnung	Stok Stock Lager	Takım Ölçüleri (mm) Dimension (mm) Abmessung (mm)							Maks. Ofset (radial) Max. Offset (radial) Max. Versatz (radial)		Kesici Uç Insert Wendeschneidplatte	Yedek Parçaları / Spare Parts / Ersatzteile	
		DC	DCON	DCSFMS	OAL	LU	LPR	LS	X_{max}	DC_{max}		Sıkma Vidası Screw Schraube	Tork Anahtar Torx Key Torx-Schlüssel
ATUM 16XD2 WCM. 030208	●	16	25	34	110	32	54	56	1.5	19	WCM. 030208	3008-M2.5x6	82-T08
ATUM 16.5XD2 WCM. 030208	●	16.5	25	34	110	32	54	56	1.5	19.5			
ATUM 17XD2 WCM. 030208	●	17	25	34	112	34	56	56	1.5	20			
ATUM 17.5XD2 WCM. 030208	●	17.5	25	34	112	34	56	56	1.5	20.5			
ATUM 18XD2 WCM. 030208	●	18	25	34	114	36	58	56	1.4	20.8			
ATUM 18.5XD2 WCM. 030208	●	18.5	25	34	114	36	58	56	1.3	21.1			
ATUM 19XD2 WCM. 030208	●	19	25	34	116	38	60	56	1.2	21.4			
ATUM 19.5XD2 WCM. 030208	●	19.5	25	34	116	38	60	56	1.2	21.9			
ATUM 20XD2 WCM. 040208	●	20	25	34	118	40	62	56	1.5	23			
ATUM 20.5XD2 WCM. 040208	●	20.5	25	34	118	40	62	56	1.5	23.5			
ATUM 21XD2 WCM. 040208	●	21	25	34	120	42	64	56	1	23			
ATUM 21.5XD2 WCM. 040208	●	21.5	25	34	120	42	64	56	1	23.5			
ATUM 22XD2 WCM. 040208	●	22	25	34	122	44	66	56	1	24			
ATUM 22.5XD2 WCM. 040208	●	22.5	25	34	122	44	66	56	1	24.5			
ATUM 23XD2 WCM. 040208	●	23	25	34	124	46	68	56	1	25			
ATUM 23.5XD2 WCM. 040208	●	23.5	25	34	124	46	68	56	1	25.5			
ATUM 24XD2 WCM. 050308	●	24	25	34	126	48	70	56	1.4	26.8	WCM. 050308	3008-M3x8	82-T08
ATUM 24.5XD2 WCM. 050308	●	24.5	25	34	126	48	70	56	1.4	27.3			
ATUM 25XD2 WCM. 050308	●	25	25	34	128	50	72	56	1.45	27.9			
ATUM 25.5XD2 WCM. 050308	●	25.5	25	34	128	50	72	56	1.45	28.4			
ATUM 26XD2 WCM. 050308	●	26	25	34	130	52	74	56	1.45	28.9			
ATUM 26.5XD2 WCM. 050308	●	26.5	25	34	130	52	74	56	1.45	29.4			
ATUM 27XD2 WCM. 050308	●	27	25	34	132	54	76	56	1.45	29.9			
ATUM 27.5XD2 WCM. 050308	●	27.5	25	34	132	54	76	56	1.45	30.4			
ATUM 28XD2 WCM. 050308	●	28	25	34	134	56	78	56	1.6	31.2			
ATUM 28.5XD2 WCM. 050308	●	28.5	25	34	134	56	78	56	1.6	31.7			
ATUM 29XD2 WCM. 050308	●	29	25	34	136	58	80	56	1.65	32.3			
ATUM 29.5XD2 WCM. 050308	●	29.5	25	34	136	58	80	56	1.65	32.8			

R: Sağ / Right / Rechts/ L: Sol / Left / Links

● Stokta / In Stock / Auf Lager ○ Stokta Yok / Non Stock Item / Kein Lagerartikel, Lieferzeit auf Anfrage

ISO Ucuna Uygun. / Compatible with ISO Insert. / Kompatibel mit ISO Wendeplatten.

Sipariş Örneği/Ordering Example/Bestellbeispiel

1 ad./pcs./stück ATUM 16XD2 WCM. 030208

Takma Uçlu Matkap Kullanım Kılavuzu : S 427 / User's Guide For U-Drills : P 427

Bedienungsanleitung für Vollbohrer : S 427



Delme Derinliği
Drilling Depth
Bohrtiefe

= 2x Çap
= 2x Diameter
= 2x Durchmesser

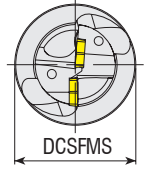
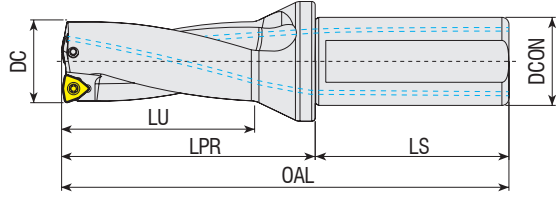

Takım Kodu Ordering Code Bestell-Bezeichnung	Stok Stock Lager	Takım Ölçüleri (mm) Dimension (mm) Abmessung (mm)							Maks. Offset (radyal) Max. Offset (radial) Max. Versatz (radial)		Kesici Uç Insert Wendeschneidplatte	Yedek Parçaları / Spare Parts / Ersatzteile	
		DC	DCON	DCSFMS	OAL	LU	LPR	LS	X _{max} [mm]	DC _{max} [mm]		Sıkma Vidası Screw Schraube	Tork Anahtar Torx Key Torx-Schlüssel
ATUM 30XD2 WCM. 06T308	●	30	32	44	147	60	87	60	2.4	34.8	WCM. 06T308	3010-M3.5x9	82-T10
new ATUM 30.5XD2 WCM. 06T308	●	30.5	32	44	147	60	87	60	2.4	35.3			
ATUM 31XD2 WCM. 06T308	●	31	32	44	149	62	89	60	2.3	35.6			
ATUM 32XD2 WCM. 06T308	●	32	32	44	151	64	91	60	2.1	36.2			
ATUM 33XD2 WCM. 06T308	●	33	32	44	153	66	93	60	1.9	36.8			
ATUM 34XD2 WCM. 06T308	●	34	32	44	155	68	95	60	1.9	37.8			
ATUM 35XD2 WCM. 06T308	●	35	32	44	157	70	97	60	1.9	38.8			
ATUM 36XD2 WCM. 06T308	●	36	32	44	159	72	99	60	2	40			
ATUM 37XD2 WCM. 06T308	●	37	32	44	161	74	101	60	1.8	40.6			
ATUM 38XD2 WCM. 06T308	●	38	32	44	163	76	103	60	1.5	41			
ATUM 39XD2 WCM. 06T308	●	39	32	44	165	78	105	60	1.3	41.6			
ATUM 40XD2 WCM. 06T308	●	40	32	44	167	80	107	60	1	42			
ATUM 41XD2 WCM. 06T308	●	41	32	44	169	82	109	60	0.8	42.6			
ATUM 42XD2 WCM. 06T308	●	42	32	44	171	84	111	60	0.5	43			
ATUM 43XD2 WCM. 06T308	●	43	32	44	173	86	113	60	0.3	43.6			
ATUM 44XD2 WCM. 06T308	●	44	32	44	175	88	115	60	0	44			
ATUM 45XD2 WCM. 080412	●	45	40	54	192	90	122	70	3.3	51.6	WCM. 080412	4015-M4x11	80-T15
ATUM 46XD2 WCM. 080412	●	46	40	54	194	92	124	70	3	52			
ATUM 47XD2 WCM. 080412	●	47	40	54	196	94	126	70	2.8	52.6			
ATUM 48XD2 WCM. 080412	●	48	40	54	198	96	128	70	2.5	53			
ATUM 49XD2 WCM. 080412	●	49	40	54	200	98	130	70	2.2	53.4			
ATUM 50XD2 WCM. 080412	●	50	40	54	202	100	132	70	2	54			
ATUM 51XD2 WCM. 080412	●	51	40	54	204	102	134	70	1.8	54.6			
ATUM 52XD2 WCM. 080412	●	52	40	54	206	104	136	70	1.5	55			
ATUM 53XD2 WCM. 080412	●	53	40	54	208	106	138	70	1.3	55.6			
ATUM 54XD2 WCM. 080412	●	54	40	54	210	108	140	70	1	56			
ATUM 55XD2 WCM. 080412	●	55	40	54	212	110	142	70	0.8	56.6			
ATUM 56XD2 WCM. 080412	●	56	40	64	214	112	144	70	0.5	57			
ATUM 57XD2 WCM. 080412	●	57	40	64	216	114	146	70	0.3	57.6			
ATUM 58XD2 WCM. 080412	●	58	40	64	218	116	148	70	0	58			
ATUM 59XD2 WCM. 080412	●	59	40	64	220	118	150	70	0	59			
ATUM 60XD2 WCM. 080412	●	60	40	64	222	120	152	70	0	60			

R: Sağ / Right / Rechts/ L: Sol / Left / Links

● Stokta / In Stock / Auf Lager ○ Stokta Yok / Non Stock Item / Kein Lagerartikel, Lieferzeit auf Anfrage

ISO Ucuna Uygundur. / Compatible with ISO Insert. / Kompatibel mit ISO Wendeplatten.

Takma Uçlu Matkap Kullanım Kılavuzu : S 427 / User's Guide For U-Drills : P 427 | Bedienungsanleitung für Vollbohrer : S 427

Sipariş Örneği/Ordering Example/Bestellbeispiel

1 ad./pcs./stück ATUM 30XD2 WCM. 06T308



Delme Derinliği
Drilling Depth
Bohrtiefe

= 3x Çap
= 3x Diameter
= 3x Durchmesser

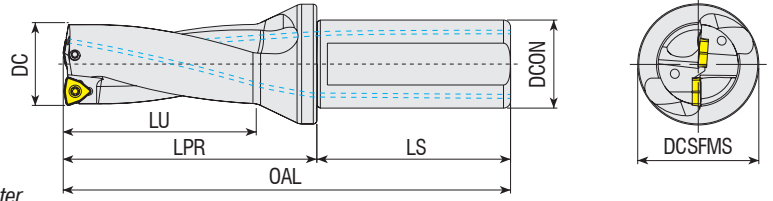

Takım Kodu
Ordering Code
Bestell-Bezeichnung

Stok
Stock
Lager

Takım Ölçüleri (mm)
Dimension (mm)
Abmessung (mm)

Maks. Ofset (radyal)
Max. Offset (radial)
Max. Versatz (radial)

Kesici Uç
Insert
Wendeschneidplatte

Yedek Parçaları / Spare Parts / Ersatzteile

Sıkma Vidası
Screw
Schraube

Tork Anahtar
Torx Key
Torx-Schlüssel

Takım Kodu Ordering Code Bestell-Bezeichnung	Stok Stock Lager	Takım Ölçüleri (mm) Dimension (mm) Abmessung (mm)							Maks. Ofset (radyal) Max. Offset (radial) Max. Versatz (radial)		Kesici Uç Insert Wendeschneidplatte	Sıkma Vidası Screw Schraube	Tork Anahtar Torx Key Torx-Schlüssel
		DC	DCON	DCSFMS	OAL	LU	LPR	LS	X _{max} [mm]	DC _{max} [mm]			
ATUM 16XD3 WCM. 030208	●	16	25	34	126	48	70	56	1.5	19	WCM. 030208	3008-M2.5x6	82-T08
ATUM 16.5XD3 WCM. 030208	●	16.5	25	34	126	48	70	56	1.5	19.5			
ATUM 17XD3 WCM. 030208	●	17	25	34	129	51	73	56	1.5	20			
ATUM 17.5XD3 WCM. 030208	●	17.5	25	34	129	51	73	56	1.5	20.5			
ATUM 18XD3 WCM. 030208	●	18	25	34	132	54	76	56	1.4	20.8			
ATUM 18.5XD3 WCM. 030208	●	18.5	25	34	132	54	76	56	1.3	21.1			
ATUM 19XD3 WCM. 030208	●	19	25	34	135	57	79	56	1.2	21.4			
ATUM 19.5XD3 WCM. 030208	●	19.5	25	34	135	57	79	56	1.2	21.9			
ATUM 20XD3 WCM. 040208	●	20	25	34	138	60	82	56	1.5	23	WCM. 040208	3008-M2.5x6	82-T08
ATUM 20.5XD3 WCM. 040208	●	20.5	25	34	138	60	82	56	1.5	23.5			
ATUM 21XD3 WCM. 040208	●	21	25	34	141	63	85	56	1	23			
ATUM 21.5XD3 WCM. 040208	●	21.5	25	34	141	63	85	56	1	23.5			
ATUM 22XD3 WCM. 040208	●	22	25	34	144	66	88	56	1	24			
ATUM 22.5XD3 WCM. 040208	●	22.5	25	34	144	66	88	56	1	24.5			
ATUM 23XD3 WCM. 040208	●	23	25	34	147	69	91	56	1	25			
ATUM 23.5XD3 WCM. 040208	●	23.5	25	34	147	69	91	56	1	25.5			
ATUM 24XD3 WCM. 050308	●	24	25	34	150	72	94	56	1.4	26.8	WCM. 050308	3008-M3x8	82-T08
ATUM 24.5XD3 WCM. 050308	●	24.5	25	34	150	72	94	56	1.4	27.3			
ATUM 25XD3 WCM. 050308	●	25	25	34	153	75	97	56	1.45	27.9			
ATUM 25.5XD3 WCM. 050308	●	25.5	25	34	153	75	97	56	1.45	28.4			
ATUM 26XD3 WCM. 050308	●	26	25	34	156	78	100	56	1.45	28.9			
ATUM 26.5XD3 WCM. 050308	●	26.5	25	34	156	78	100	56	1.45	29.4			
ATUM 27XD3 WCM. 050308	●	27	25	34	159	81	103	56	1.45	29.9			
ATUM 27.5XD3 WCM. 050308	●	27.5	25	34	159	81	103	56	1.45	30.4			
ATUM 28XD3 WCM. 050308	●	28	25	34	162	84	106	56	1.6	31.2	WCM. 06T308	3010-M3.5x9	82-T10
ATUM 28.5XD3 WCM. 050308	●	28.5	25	34	162	84	106	56	1.6	31.7			
ATUM 29XD3 WCM. 050308	●	29	25	34	165	87	109	56	1.65	32.3			
ATUM 29.5XD3 WCM. 050308	●	29.5	25	34	165	87	109	56	1.65	32.8			
ATUM 30XD3 WCM. 06T308	●	30	32	44	177	90	117	60	2.4	34.8			
ATUM 30.5XD3 WCM. 06T308	●	30.5	32	44	177	90	117	60	2.4	35.3			
ATUM 31XD3 WCM. 06T308	●	31	32	44	180	93	120	60	2.3	35.6			
ATUM 31.5XD3 WCM. 06T308	●	31.5	32	44	180	93	120	60	2.3	36.1			
ATUM 32XD3 WCM. 06T308	●	32	32	44	183	96	123	60	2.1	36.2			
ATUM 32.5XD3 WCM. 06T308	●	32.5	32	44	183	96	123	60	2.1	36.7			
ATUM 33XD3 WCM. 06T308	●	33	32	44	186	99	126	60	1.9	36.8			
ATUM 33.5XD3 WCM. 06T308	●	33.5	32	44	186	99	126	60	1.9	37.3			
ATUM 34XD3 WCM. 06T308	●	34	32	44	189	102	129	60	1.9	37.8			
ATUM 34.5XD3 WCM. 06T308	●	34.5	32	44	189	102	129	60	1.9	38.3			

R: Sağ / Right / Rechts/ L: Sol / Left / Links

● Stokta / In Stock / Auf Lager ○ Stokta Yok / Non Stock Item / Kein Lagerartikel, Lieferzeit auf Anfrage

ISO Ucuna Uygundur. / Compatible with ISO Insert. / Kompatibel mit ISO Wendeplatten.

Sipariş Örneği/Ordering Example/Bestellbeispiel

1 ad./pcs./stück ATUM 16XD3 WCM. 030208

Takma Uçlu Matkap Kullanım Kılavuzu : S 427 / User's Guide For U-Drills : P 427

Bedienungsanleitung für Vollbohrer : S 427



Delme Derinliği
Drilling Depth
Bohrtiefe

= 3x Çap
= 3x Diameter
= 3x Durchmesser

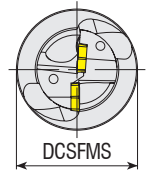
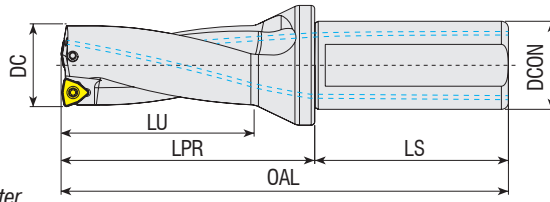

Takım Kodu Ordering Code Bestell-Bezeichnung	Stok Stock Lager	Takım Ölçüleri (mm) Dimension (mm) Abmessung (mm)							Maks. Ofset (radyal) Max. Offset (radial) Max. Versatz (radial)		Kesici Uç Insert Wendeschneidplatte	Yedek Parçaları / Spare Parts / Ersatzteile		
		DC	DCON	DCSFMS	OAL	LU	LPR	LS	X _{max}	DC _{max}		Sıkma Vidası Screw Schraube	Tork Anahtar Torx Key Torx-Schlüssel	
ATUM 35XD3 WCM. 06T308	●	35	32	44	192	105	132	60	1.9	38.8	WCM. 06T308	3010-M3.5x9	82-T10	
ATUM 35.5XD3 WCM. 06T308	●	35.5	32	44	192	105	132	60	1.9	39.3				
ATUM 36XD3 WCM. 06T308	●	36	32	44	195	108	135	60	2	40				
ATUM 36.5XD3 WCM. 06T308	●	36.5	32	44	195	108	135	60	2	40.5				
ATUM 37XD3 WCM. 06T308	●	37	32	44	198	111	138	60	1.8	40.6				
ATUM 37.5XD3 WCM. 06T308	●	37.5	32	44	198	111	138	60	1.8	41.1				
ATUM 38XD3 WCM. 06T308	●	38	32	44	201	114	141	60	1.5	41				
ATUM 38.5XD3 WCM. 06T308	●	38.5	32	44	201	114	141	60	1.5	41.5				
ATUM 39XD3 WCM. 06T308	●	39	32	44	204	117	144	60	1.3	41.6				
ATUM 39.5XD3 WCM. 06T308	●	39.5	32	44	204	117	144	60	1.3	42.1				
ATUM 40XD3 WCM. 06T308	●	40	32	44	207	120	147	60	1	42				
ATUM 40.5XD3 WCM. 06T308	●	40.5	32	44	207	120	147	60	1	42.5				
ATUM 41XD3 WCM. 06T308	●	41	32	44	210	123	150	60	0.8	42.6				
ATUM 41.5XD3 WCM. 06T308	●	41.5	32	44	210	123	150	60	0.8	43.1				
ATUM 42XD3 WCM. 06T308	●	42	32	44	213	126	153	60	0.5	43				
ATUM 42.5XD3 WCM. 06T308	●	42.5	32	44	213	126	153	60	0.5	43.5				
ATUM 43XD3 WCM. 06T308	●	43	32	44	216	129	156	60	0.3	43.6				
ATUM 43.5XD3 WCM. 06T308	●	43.5	32	44	216	129	156	60	0.3	44.1				
ATUM 44XD3 WCM. 06T308	●	44	32	44	219	132	159	60	0	44				
ATUM 44.5XD3 WCM. 06T308	●	44.5	32	44	219	132	159	60	0	44.5				
ATUM 45XD3 WCM. 080412	●	45	40	54	237	135	167	70	3.3	51.6	WCM. 080412	4015-M4x11	80-T15	
ATUM 45.5XD3 WCM. 080412	●	45.5	40	54	237	135	167	70	3.3	52.1				
ATUM 46XD3 WCM. 080412	●	46	40	54	240	138	170	70	3	52				
ATUM 47XD3 WCM. 080412	●	47	40	54	243	141	173	70	2.8	52.6				
ATUM 48XD3 WCM. 080412	●	48	40	54	246	144	176	70	2.5	53				
ATUM 49XD3 WCM. 080412	●	49	40	54	249	147	179	70	2.2	53.4				
ATUM 50XD3 WCM. 080412	●	50	40	54	252	150	182	70	2	54				
ATUM 51XD3 WCM. 080412	●	51	40	54	255	153	185	70	1.8	54.6				
ATUM 52XD3 WCM. 080412	●	52	40	54	258	156	188	70	1.5	55				
ATUM 53XD3 WCM. 080412	●	53	40	54	261	159	191	70	1.3	55.6				
ATUM 54XD3 WCM. 080412	●	54	40	54	264	162	194	70	1	56				
ATUM 55XD3 WCM. 080412	●	55	40	54	267	165	197	70	0.8	56.6				
ATUM 56XD3 WCM. 080412	●	56	40	64	270	168	200	70	0.5	57				
ATUM 57XD3 WCM. 080412	●	57	40	64	273	171	203	70	0.3	57.6				
ATUM 58XD3 WCM. 080412	●	58	40	64	276	174	206	70	0	58				
ATUM 59XD3 WCM. 080412	●	59	40	64	279	177	209	70	0	59				
ATUM 60XD3 WCM. 080412	●	60	40	64	282	180	212	70	0	60				

R: Sağ / Right / Rechts/ L: Sol / Left / Links

● Stokta / In Stock / Auf Lager ○ Stokta Yok / Non Stock Item / Kein Lagerartikel, Lieferzeit auf Anfrage

ISO Ucuna Uygundur. / Compatible with ISO Insert. / Kompatibel mit ISO Wendeplatten.

Sipariş Örneği/Ordering Example/Bestellbeispiel

1 ad./pcs./stück ATUM 35XD3 WCM. 06T308

Takma Uçlu Matkap Kullanım Kılavuzu : S 427 / User's Guide For U-Drills : P 427

Bedienungsanleitung für Vollbohrer : S 427



Delme Derinliği
Drilling Depth
Bohrtiefe

= 4x Çap
= 4x Diameter
= 4x Durchmesser

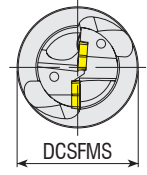
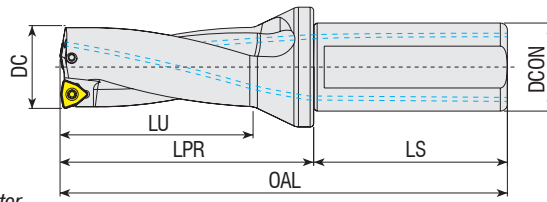

Takım Kodu Ordering Code Bestell-Bezeichnung	Stok Stock Lager	Takım Ölçüleri (mm) Dimension (mm) Abmessung (mm)							Maks. Ofset (radyal) Max. Offset (radial) Max. Versatz (radial)		Kesici Uç Insert Wendeschneidplatte	Yedek Parçaları / Spare Parts / Ersatzteile				
		DC	DCON	DCSFMS	OAL	LU	LPR	LS	X _{max}	DC _{max}		Sıkma Vidası Screw Schraube	Tork Anahtar Torx Key Torx-Schlüssel			
ATUM 16XD4 WCM. 030208	●	16	25	34	142	64	86	56	1.5	19	WCM. 030208	3008-M2.5x6				
ATUM 16.5XD4 WCM. 030208	○	16.5	25	34	142	64	86	56	1.5	19.5						
ATUM 17XD4 WCM. 030208	●	17	25	34	146	68	90	56	1.5	20						
ATUM 17.5XD4 WCM. 030208	●	17.5	25	34	146	68	90	56	1.5	20.5						
ATUM 18XD4 WCM. 030208	●	18	25	34	150	72	94	56	1.4	20.8						
ATUM 18.5XD4 WCM. 030208	○	18.5	25	34	150	72	94	56	1.3	21.1						
ATUM 19XD4 WCM. 030208	●	19	25	34	154	76	98	56	1.2	21.4						
ATUM 19.5XD4 WCM. 030208	○	19.5	25	34	154	76	98	56	1.2	21.9						
ATUM 20XD4 WCM. 040208	●	20	25	34	158	80	102	56	1.5	23				WCM. 040208	3008-M2.5x6	82-T08
ATUM 20.5XD4 WCM. 040208	○	20.5	25	34	158	80	102	56	1.5	23.5						
ATUM 21XD4 WCM. 040208	●	21	25	34	162	84	106	56	1	23						
ATUM 21.5XD4 WCM. 040208	○	21.5	25	34	162	84	106	56	1	23.5						
ATUM 22XD4 WCM. 040208	●	22	25	34	166	88	110	56	1	24						
ATUM 22.5XD4 WCM. 040208	●	22.5	25	34	166	88	110	56	1	24.5						
ATUM 23XD4 WCM. 040208	●	23	25	34	170	92	114	56	1	25	WCM. 050308	3008-M3x8				
ATUM 23.5XD4 WCM. 040208	○	23.5	25	34	170	92	114	56	1	25.5						
ATUM 24XD4 WCM. 050308	●	24	25	34	174	96	118	56	1.4	26.8						
ATUM 24.5XD4 WCM. 050308	○	24.5	25	34	174	96	118	56	1.4	27.3						
ATUM 25XD4 WCM. 050308	●	25	25	34	178	100	122	56	1.45	27.9						
ATUM 25.5XD4 WCM. 050308	○	25.5	25	34	178	100	122	56	1.45	28.4						
ATUM 26XD4 WCM. 050308	●	26	25	34	182	104	126	56	1.45	28.9						
ATUM 26.5XD4 WCM. 050308	●	26.5	25	34	182	104	126	56	1.45	29.4						
ATUM 27XD4 WCM. 050308	●	27	25	34	186	108	130	56	1.45	29.9						
ATUM 27.5XD4 WCM. 050308	○	27.5	25	34	186	108	130	56	1.45	30.4						
ATUM 28XD4 WCM. 050308	●	28	25	34	190	112	134	56	1.6	31.2						
ATUM 28.5XD4 WCM. 050308	●	28.5	25	34	190	112	134	56	1.6	31.7						
ATUM 29XD4 WCM. 050308	●	29	25	34	194	116	138	56	1.65	32.3						
ATUM 29.5XD4 WCM. 050308	○	29.5	25	34	194	116	138	56	1.65	32.8						

R: Sağ / Right / Rechts/ L: Sol / Left / Links

● Stokta / In Stock / Auf Lager ○ Stokta Yok / Non Stock Item / Kein Lagerartikel, Lieferzeit auf Anfrage

ISO Ucuna Uygundur. / Compatible with ISO Insert. / Kompatibel mit ISO Wendeplatten.

Sipariş Örneği/Ordering Example/Bestellbeispiel

1 ad./pcs./stück ATUM 16XD4 WCM. 030208

Takma Uçlu Matkap Kullanım Kılavuzu : S 427 / User's Guide For U-Drills : P 427

Bedienungsanleitung für Vollbohrer : S 427



Delme Derinliği
Drilling Depth
Bohrtiefe
= 4x Çap
= 4x Diameter
= 4x Durchmesser

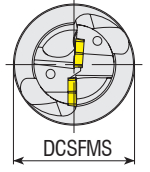
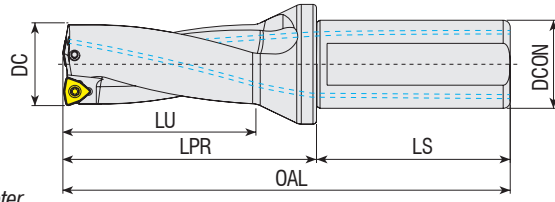

Takım Kodu Ordering Code Bestell-Bezeichnung	Stok Stock Lager	Takım Ölçüleri (mm) Dimension (mm) Abmessung (mm)							Maks. Ofset (radyal) Max. Offset (radial) Max. Versatz (radial)		Kesici Uç Insert Wendeschneidplatte	Yedek Parçaları / Spare Parts / Ersatzteile	
		DC	DCON	DCSFMS	OAL	LU	LPR	LS	X _{max}	DC _{max}		Sıkma Vidası Screw Schraube	Tork Anahtar Torx Key Torx-Schlüssel
ATUM 30XD4 WCM. 06T308	●	30	32	44	207	120	147	60	2.4	34.8	WCM. 06T308	3010-M3.5x9	82-T10
ATUM 31XD4 WCM. 06T308	●	31	32	44	211	124	151	60	2.3	35.6			
ATUM 32XD4 WCM. 06T308	●	32	32	44	215	128	155	60	2.1	36.2			
ATUM 33XD4 WCM. 06T308	●	33	32	44	219	132	159	60	1.9	36.8			
ATUM 33.5XD4 WCM. 06T308	●	33.5	32	44	219	132	159	60	1.9	37.3			
ATUM 34XD4 WCM. 06T308	●	34	32	44	223	136	163	60	1.9	37.8			
ATUM 35XD4 WCM. 06T308	●	35	32	44	227	140	167	60	1.9	38.8			
ATUM 36XD4 WCM. 06T308	●	36	32	44	231	144	171	60	2	40			
ATUM 37XD4 WCM. 06T308	●	37	32	44	235	148	175	60	1.8	40.6			
ATUM 38XD4 WCM. 06T308	●	38	32	44	239	152	179	60	1.5	41			
ATUM 38.5XD4 WCM. 06T308	●	38.5	32	44	239	152	179	60	1.5	41.5			
ATUM 39XD4 WCM. 06T308	●	39	32	44	243	156	183	60	1.3	41.6			
ATUM 40XD4 WCM. 06T308	●	40	32	44	247	160	187	60	1	42			
ATUM 41XD4 WCM. 06T308	●	41	32	44	251	164	191	60	0.8	42.6			
ATUM 42XD4 WCM. 06T308	●	42	32	44	255	168	195	60	0.5	43			
ATUM 43XD4 WCM. 06T308	●	43	32	44	259	172	199	60	0.3	43.6			
ATUM 44XD4 WCM. 06T308	●	44	32	44	263	176	203	60	0	44			
ATUM 45XD4 WCM. 080412	●	45	40	54	282	180	212	70	3.3	51.6	WCM. 080412	4015-M4x11	80-T15
ATUM 46XD4 WCM. 080412	●	46	40	54	286	184	216	70	3	52			
ATUM 47XD4 WCM. 080412	●	47	40	54	290	188	220	70	2.8	52.6			
ATUM 48XD4 WCM. 080412	●	48	40	54	294	192	224	70	2.5	53			
ATUM 49XD4 WCM. 080412	●	49	40	54	298	196	228	70	2.2	53.4			
ATUM 50XD4 WCM. 080412	●	50	40	54	302	200	232	70	2	54			

R: Sağ / Right / Rechts/ L: Sol / Left / Links

● Stokta / In Stock / Auf Lager ○ Stokta Yok / Non Stock Item / Kein Lagerartikel, Lieferzeit auf Anfrage

ISO Ucuna Uygundur. / Compatible with ISO Insert. / Kompatibel mit ISO Wendeplatten.

Sipariş Örneği/Ordering Example/Bestellbeispiel

1 ad./pcs./stück ATUM 30XD4 WCM. 06T308

Takma Uçlu Matkap Kullanım Kılavuzu : S 427 / User's Guide For U-Drills : P 427

Bedienungsanleitung für Vollbohrer : S 427



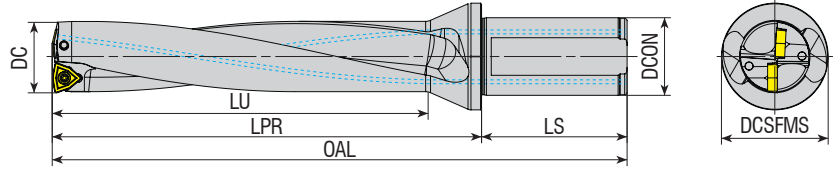

Delme Derinliği
Drilling Depth
Bohrtiefe

= 5x Çap
= 5x Diameter
= 5x Durchmesser

Takım Kodu Ordering Code Bestell-Bezeichnung	Stok Stock Lager	Takım Ölçüleri (mm) Dimension (mm) Abmessung (mm)							Maks. Ofset (radyal) Max. Offset (radial) Max. Versatz (radial)		Kesici Uç Insert Wendeschneidplatte	Yedek Parçaları / Spare Parts / Ersatzteile	
		DC	DCON	DCSFMS	OAL	LU	LPR	LS	X _{max}	X _{max} [mm]		DC _{max} [mm]	Sıkma Vidası Screw Schraube
ATUM 20XD5 WCM. 040208	●	20	25	34	178	100	122	56	1.5	23	WCM. 040208	3008-M2.5x6	82-T08
ATUM 21XD5 WCM. 040208	●	21	25	34	183	105	127	56	1	23			
ATUM 22XD5 WCM. 040208	●	22	25	34	188	110	132	56	1	24			
ATUM 23XD5 WCM. 040208	●	23	25	34	193	115	137	56	1	25			
ATUM 24XD5 WCM. 050308	●	24	25	34	198	120	142	56	1.4	26.8	WCM. 050308	3008-M3x8	82-T08
ATUM 25XD5 WCM. 050308	●	25	25	34	203	125	147	56	1.45	27.9			
ATUM 26XD5 WCM. 050308	●	26	25	34	208	130	152	56	1.45	28.9			
ATUM 27XD5 WCM. 050308	●	27	25	34	213	135	157	56	1.45	29.9			
ATUM 28XD5 WCM. 050308	●	28	25	34	218	140	162	56	1.6	31.2			
ATUM 29XD5 WCM. 050308	●	29	25	34	223	145	167	56	1.65	32.3			
ATUM 30XD5 WCM. 06T308	●	30	32	44	237	150	177	60	2.4	34.8	WCM. 06T308	3010-M3.5x9	82-T10
ATUM 31XD5 WCM. 06T308	●	31	32	44	242	155	182	60	2.3	35.6			
ATUM 32XD5 WCM. 06T308	●	32	32	44	247	160	187	60	2.1	36.2			
ATUM 33XD5 WCM. 06T308	●	33	32	44	252	165	192	60	1.9	36.8			
ATUM 34XD5 WCM. 06T308	●	34	32	44	257	170	197	60	1.9	37.8			
ATUM 35XD5 WCM. 06T308	●	35	32	44	262	175	202	60	1.9	38.8			
ATUM 37XD5 WCM. 06T308	●	37	32	44	272	185	212	60	1.8	40.6			
ATUM 38XD5 WCM. 06T308	●	38	32	44	277	190	217	60	1.5	41			
ATUM 46XD5 WCM. 080412	●	46	40	54	332	230	262	70	3	52	WCM. 080412	4015-M4x11	80-T15
new ATUM 49XD5 WCM. 080412	●	49	40	54	347	245	277	70	2.2	53.4			

R: Sağ / Right / Rechtsl L: Sol / Left / Links

● Stokta / In Stock / Auf Lager ○ Stokta Yok / Non Stock Item / Kein Lagerartikel, Lieferzeit auf Anfrage

ISO Uçuna Uygundur. / Compatible with ISO Insert. / Kompatibel mit ISO Wendeplatten.

Sipariş Örneği/Ordering Example/Bestellbeispiel

1 ad./pcs./stück ATUM 20XD5 WCM. 040208

Takma Uçlu Matkap Kullanım Kılavuzu : S 427 / User's Guide For U-Drills : P 427

Bedienungsanleitung für Vollbohrer : S 427



Delme Derinliği
Drilling Depth
Bohrtiefe

= 3x Çap
= 3x Diameter
= 3x Durchmesser

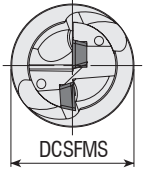
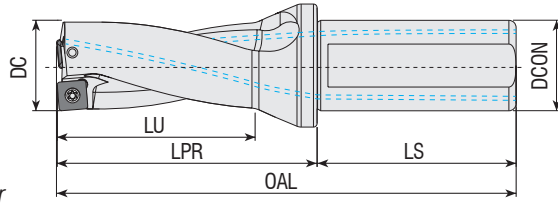

Takım Kodu Ordering Code Bestell-Bezeichnung	Stok Stock Lager	Takım Ölçüleri (mm) Dimension (mm) Abmessung (mm)							Maks. Ofset (radyal) Max. Offset (radial) Max. Versatz (radial)		Kesici Uç Insert Wendeschneidplatte	Yedek Parçaları / Spare Parts / Ersatzteile	
		DC	DCON	DCSFMS	OAL	LU	LPR	LS	X _{max} [mm]	DC _{max} [mm]		Sıkma Vidası Screw Schraube	Tork Anahtar Torx Key Torx-Schlüssel
ATUM 14XD3 SO.. 050204	●	14	20	25	114	42	64	50	1.4	16.8	SO.. 050204	3006-M2x4	82-T06
ATUM 15XD3 SO.. 050204	●	15	20	25	117	45	67	50	1.2	17.4			
ATUM 16XD3 SO.. 050204	●	16	25	34	126	48	70	56	0.9	17.8			
ATUM 16.5XD3 SO.. 050204	●	16.5	25	34	126	48	70	56	0.8	18.1			
ATUM 17XD3 SO.. 050204	●	17	25	34	129	51	73	56	0.65	18.3			
ATUM 17.5XD3 SO.. 050204	●	17.5	25	34	129	51	73	56	0.5	18.5			
ATUM 18XD3 SO.. 060304	●	18	25	34	132	54	76	56	1.15	20.3	SO.. 060304	3007-M2.2x4.6	82-T07
ATUM 19XD3 SO.. 060304	●	19	25	34	135	57	79	56	0.9	20.8			
ATUM 20XD3 SO.. 060304	●	20	25	34	138	60	82	56	0.65	21.3			
ATUM 21XD3 SO.. 070305	●	21	25	34	141	63	85	56	1.75	24.5	SO.. 070305	3008-M2.5x6	82-T08
ATUM 22XD3 SO.. 070305	●	22	25	34	144	66	88	56	1.5	25			
ATUM 22.5XD3 SO.. 070305	●	22.5	25	34	144	66	88	56	1.35	25.2			
ATUM 23XD3 SO.. 070305	●	23	25	34	147	69	91	56	1.25	25.5			
ATUM 24XD3 SO.. 070305	●	24	25	34	150	72	94	56	1	26			
ATUM 25XD3 SO.. 09T306	●	25	25	34	153	75	97	56	2.25	29.5			
ATUM 26XD3 SO.. 09T306	●	26	25	34	156	78	100	56	2	30	SO.. 09T306	4010-M3x8	82-T10
ATUM 27XD3 SO.. 09T306	●	27	25	34	159	81	103	56	1.75	30.5			
ATUM 29XD3 SO.. 09T306	●	29	25	34	174	87	114	56	1.25	31.5			
ATUM 30XD3 SO.. 09T306	●	30	32	44	177	90	117	60	1	32			
ATUM 31XD3 SO.. 09T306	●	31	32	44	200	93	120	60	0.75	32.5			
ATUM 33XD3 SO.. 09T306	●	33	32	44	186	99	126	60	0.5	34			
ATUM 35XD3 SO.. 120408	●	35	32	44	192	105	132	60	2.75	40.5	SO.. 120408	4015-M4X11	80-T15
ATUM 36XD3 SO.. 120408	●	36	32	44	195	108	135	60	2.5	41			
ATUM 37XD3 SO.. 120408	●	37	32	44	198	111	138	60	2.25	41.5			
ATUM 38XD3 SO.. 120408	●	38	32	44	201	114	141	60	1.75	41.5			
ATUM 39XD3 SO.. 120408	●	39	32	44	204	117	144	60	1.75	42.5			
ATUM 40XD3 SO.. 120408	●	40	32	44	207	120	147	60	1.5	43			
ATUM 43XD3 SO.. 120408	●	43	32	44	216	129	156	60	0.75	44.5			

R: Sağ / Right / Rechts / L: Sol / Left / Links

● Stokta / In Stock / Auf Lager ○ Stokta Yok / Non Stock Item / Kein Lagerartikel, Lieferzeit auf Anfrage

ISCR Ucuna Uygundur. / Compatible with ISCR Insert. / Kompatibel mit ISCR Wendeplatten.

Sipariş Örneği/Ordering Example/Bestellbeispiel

1 ad./pcs./stück ATUM 14XD3 SO.. 050204

Takma Uçlu Matkap Kullanım Kılavuzu : S 427 / User's Guide For U-Drills : P 427

Bedienungsanleitung für Vollbohrer : S 427



Delme Derinliği
Drilling Depth
Bohrtiefe

= 4x Çap
= 4x Diameter
= 4x Durchmesser

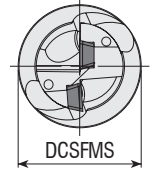
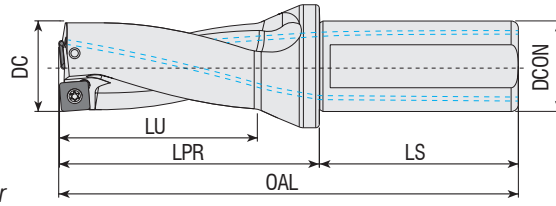

Takım Kodu
Ordering Code
Bestell-Bezeichnung

Stok
Stock
Lager

Takım Ölçüleri (mm)
Dimension (mm)
Abmessung (mm)

Maks. Ofset (radyal)
Max. Offset (radial)
Max. Versatz (radial)

Kesici Uç
Insert
Wendescheidplatte

Yedek Parçaları / Spare Parts / Ersatzteile

Sıkma Vidası
Screw
Schraube

Tork Anahtar
Torx Key
Torx-Schlüssel

Takım Kodu Ordering Code Bestell-Bezeichnung	Stok Stock Lager	DC	DCON	DCSFMS	OAL	LU	LPR	LS	Maks. Ofset (radyal) Max. Offset (radial) Max. Versatz (radial)		Kesici Uç Insert Wendescheidplatte	Sıkma Vidası Screw Schraube	Tork Anahtar Torx Key Torx-Schlüssel
									X _{max}	DC _{max}			
ATUM 14XD4 SO.. 050204	●	14	20	25	128	56	78	50	1.4	16.8	SO.. 050204	3006-M2x4	82-T06
ATUM 14.5XD4 SO.. 050204	●	14.5	20	25	128	56	78	50	1.3	17.1			
ATUM 15XD4 SO.. 050204	●	15	20	25	132	60	62	50	1.2	17.4			
ATUM 15.5XD4 SO.. 050204	●	15.5	20	25	132	60	82	50	1	17.5			
ATUM 17XD4 SO.. 050204	●	17	25	34	146	68	90	56	0.65	18.3	SO.. 060304	3007-M2.2x4.6	82-T07
ATUM 19XD4 SO.. 060304	●	19	25	34	154	76	98	56	0.9	20.8			
ATUM 19.5XD4 SO.. 060304	●	19.5	25	34	154	76	98	56	0.75	21			
ATUM 20XD4 SO.. 060304	●	20	25	34	158	80	102	56	0.65	21.3			
ATUM 21XD4 SO.. 070305	●	21	25	34	162	84	106	56	1.75	24.5	SO.. 070305	3008-M2.5x6	82-T08
ATUM 22XD4 SO.. 070305	●	22	25	34	166	88	110	56	1.5	25			
ATUM 22.5XD4 SO.. 070305	●	22.5	25	34	166	88	110	56	1.35	25.2			
ATUM 23XD4 SO.. 070305	●	23	25	34	170	92	114	56	1.25	25.5			
ATUM 24XD4 SO.. 070305	●	24	25	34	174	96	118	56	1	26	SO.. 09T306	4010-M3x8	82-T10
ATUM 25XD4 SO.. 09T306	●	25	25	34	178	100	122	56	2.25	29.5			
ATUM 27XD4 SO.. 09T306	●	27	25	34	186	108	130	56	1.75	30.5			
ATUM 28XD4 SO.. 09T306	●	28	25	34	190	112	134	56	1.5	31			
ATUM 29XD4 SO.. 09T306	●	29	25	34	194	116	138	56	1.25	31.5	SO.. 120408	4015-M4X11	80-T15
ATUM 30XD4 SO.. 09T306	●	30	32	44	207	120	147	60	1	32			
ATUM 31XD4 SO.. 09T306	●	31	32	44	211	124	151	60	0.75	32.5			
ATUM 33XD4 SO.. 09T306	●	33	32	44	219	132	159	60	0.5	34			
ATUM 34XD4 SO.. 09T306	●	34	32	44	223	136	163	60	0.25	34.5	SO.. 120408	4015-M4X11	80-T15
ATUM 35XD4 SO.. 120408	●	35	32	44	227	140	167	60	2.75	40.5			

R: Sağ / Right / Rechts | L: Sol / Left / Links

● Stokta / In Stock / Auf Lager ○ Stokta Yok / Non Stock Item / Kein Lagerartikel, Lieferzeit auf Anfrage

ISCR Ucuna Uygundur. / Compatible with ISCR Insert. / Kompatibel mit ISCR Wendeplatten.

Sipariş Örneği/Ordering Example/Bestellbeispiel

1 ad./pcs./stück ATUM 14XD4 SO.. 050204

Takma Uçlu Matkap Kullanım Kılavuzu : S 427 / User's Guide For U-Drills : P 427

Bedienungsanleitung für Vollbohrer : S 427

KRLY Ucuna Uygundur. / Compatible with KRLY Insert. / Kompatibel mit KRLY Wendeplatten.



Delme Derinliği
Drilling Depth
Bohrtiefe

= 2x Çap
= 2x Diameter
= 2x Durchmesser

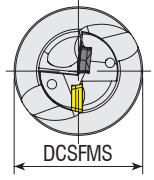
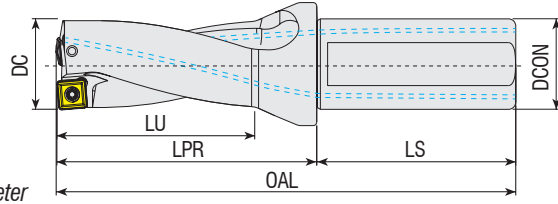

Takım Kodu Ordering Code Bestell-Bezeichnung	Stok Stock Lager	Takım Ölçüleri (mm) Dimension (mm) Abmessung (mm)								Maks. Ofset (radyal) Max. Offset (radial) Max. Versatz (radial)		Kesici Uç Insert Wendeschneidplatte	Yedek Parçaları / Spare Parts / Ersatzteile	
		DC	DCON	DCSFMS	OAL	LU	LPR	LS	X _{max}	DC _{max}	Sıkma Vidası Screw Schraube		Tork Anahtar Torx Key Torx-Schlüssel	
ATUM 14XD2 KDR 0502..	●	14	20	25	100	28	50	50	0.25	14.5	SPMT 050204-XOMT 050204	3006-M2x4	82-T06	
ATUM 18XD2 KDR 0602..	●	18	25	34	114	36	58	56	0.5	19				SPMT 060205-XOMT 060204
ATUM 20XD2 KDR 07T2..	●	20	25	34	118	40	62	56	0.3	20.6	SPMT 07T208 XOMT 07T205	3008-M2.5x6	82-T08	
ATUM 22XD2 KDR 07T2..	●	22	25	34	122	44	66	56	0.3	22.6				XOMT 07T205
ATUM 24XD2 KDR 0903..	●	24	25	34	126	48	70	56	0.3	24.6	SPMT 090308 XOMT 090305	3008-M3x7	82-T08	
ATUM 25XD2 KDR 0903..	●	25	25	34	128	50	72	56	0.3	25.6				XOMT 090305
ATUM 26XD2 KDR 0903..	●	26	25	34	130	52	74	56	0.3	26.6	SPMT 11T308 XOMT 11T306	4015-M3.5x9	80-T15	
ATUM 28XD2 KDR 0903..	●	28	25	34	134	56	78	56	0.3	28.6				XOMT 11T306
ATUM 30XD2 KDR 11T3..	●	30	32	34	147	60	87	60	0.35	30.7	SPMT 130410 XOMT 130406	4015-M4x11	80-T15	
ATUM 32XD2 KDR 11T3..	●	32	32	44	151	64	91	60	0.35	32.7				XOMT 130406
ATUM 34XD2 KDR 11T3..	●	34	32	44	155	68	95	60	0.35	34.7				
ATUM 36XD2 KDR 1304..	●	36	32	44	159	72	99	60	0.35	36.7				
ATUM 37XD2 KDR 1304..	●	37	32	44	161	74	101	60	0.35	37.7				
ATUM 38XD2 KDR 1304..	●	38	32	44	163	76	103	60	0.35	38.7				



Delme Derinliği
Drilling Depth
Bohrtiefe

= 4x Çap
= 4x Diameter
= 4x Durchmesser

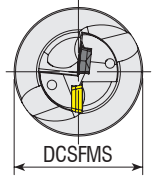
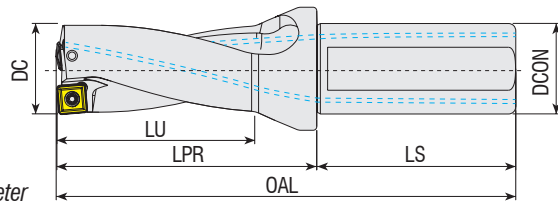

Takım Kodu Ordering Code Bestell-Bezeichnung	Stok Stock Lager	Takım Ölçüleri (mm) Dimension (mm) Abmessung (mm)								Maks. Ofset (radyal) Max. Offset (radial) Max. Versatz (radial)		Kesici Uç Insert Wendeschneidplatte	Yedek Parçaları / Spare Parts / Ersatzteile	
		DC	DCON	DCSFMS	OAL	LU	LPR	LS	X _{max}	DC _{max}	Sıkma Vidası Screw Schraube		Tork Anahtar Torx Key Torx-Schlüssel	
ATUM 14XD4 KDR 0502..	●	14	20	25	128	56	78	50	0.25	14.5	SPMT 050204 XOMT 050204	3006-M2x4	82-T06	
ATUM 14.5XD4 KDR 0502..	●	14.5	20	25	128	56	78	50	0.25	15				XOMT 050204
ATUM 15XD4 KDR 0502..	●	15	20	25	132	60	82	50	0.25	15.5	SPMT 060205 XOMT 060204	3007-M2.2x4.6	82-T07	
ATUM 15.5XD4 KDR 0502..	●	15.5	20	25	132	60	82	50	0.25	16				XOMT 060204
ATUM 16XD4 KDR 0502..	●	16	25	34	142	64	86	56	0.25	16.5	SPMT 07T208 XOMT 07T205	3008-M2.5x6	82-T08	
ATUM 17XD4 KDR 0602..	●	17	25	34	146	68	90	56	0.5	18				XOMT 07T205
ATUM 17.5XD4 KDR 0602..	●	17.5	25	34	146	68	90	56	0.5	18.5	SPMT 090308 XOMT 090305	3008-M3x7	82-T08	
ATUM 18XD4 KDR 0602..	●	18	25	34	150	72	94	56	0.5	19				XOMT 090305
ATUM 18.5XD4 KDR 0602..	●	18.5	25	34	150	72	94	56	0.5	19.5	SPMT 11T308 XOMT 11T306	4015-M3.5x9	80-T15	
ATUM 19XD4 KDR 0602..	●	19	25	34	154	76	98	56	0.5	20				XOMT 11T306
ATUM 20XD4 KDR 07T2..	●	20	25	34	158	80	102	56	0.3	20.6	SPMT 130410 XOMT 130406	4015-M4x11	80-T15	
ATUM 21XD4 KDR 07T2..	●	21	25	34	162	84	106	56	0.3	21.6				XOMT 130406
ATUM 22XD4 KDR 07T2..	●	22	25	34	166	88	110	56	0.3	22.6				
ATUM 24XD4 KDR 0903..	●	24	25	34	174	96	118	56	0.3	24.6				
ATUM 25XD4 KDR 0903..	●	25	25	34	178	100	122	56	0.3	25.6				

R: Sağ / Right / Rechts/ L: Sol / Left / Links

● Stokta / In Stock / Auf Lager ○ Stokta Yok / Non Stock Item / Kein Lagerartikel, Lieferzeit auf Anfrage

KRLY Ucuna Uygundur. / Compatible with KRLY Insert. / Kompatibel mit KRLY Wendeplatten.

Sipariş Örneği/Ordering Example/Bestellbeispiel

1 ad./pcs./stück ATUM 14XD2 KDR 0502..

Takma Uçlu Matkap Kullanım Kılavuzu : S 427 / User's Guide For U-Drills : P 427

Bedienungsanleitung für Vollbohrer : S 427



Delme Derinliği
Drilling Depth
Bohrtiefe

= 3x Çap
= 3x Diameter
= 3x Durchmesser

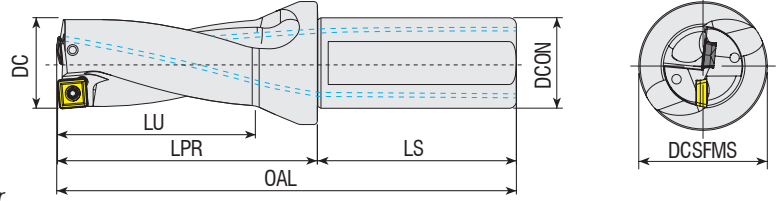

Takım Kodu Ordering Code Bestell-Bezeichnung	Stok Stock Lager	Takım Ölçüleri (mm) Dimension (mm) Abmessung (mm)							Maks. Ofset (radyal) Max. Offset (radial) Max. Versatz (radial)		Kesici Uç Insert Wendeschneidplatte	Sıkma Vidası Screw Schraube	Tork Anahtar Torx Key Torx-Schlüssel
		DC	DCON	DCSFMS	OAL	LU	LPR	LS	X _{max}	DC _{max}			
ATUM 12.5XD3 KDR 0402..	●	12.5	20	25	108	36	58	50	0.2	12.9	SPMT 040204 XOMT 040204		
ATUM 13XD3 KDR 0402..	●	13	20	25	111	39	61	50	0.2	13.4			
ATUM 14XD3 KDR 0502..	●	14	20	25	114	42	64	50	0.25	14.5	SPMT 050204 XOMT 050204	3006-M2x4	82-T06
ATUM 14.5XD3 KDR 0502..	●	14.5	20	25	114	42	64	50	0.25	15			
ATUM 15XD3 KDR 0502..	●	15	20	25	117	45	67	50	0.25	15.5	SPMT 060205 XOMT 060204	3007-M2.2x4.6	82-T07
ATUM 15.5XD3 KDR 0502..	●	15.5	20	25	117	45	67	50	0.25	16			
ATUM 16XD3 KDR 0502..	●	16	25	34	126	48	70	56	0.25	16.5	SPMT 07T208 XOMT 07T205	3008-M2.5x6	82-T08
ATUM 16.5XD3 KDR 0602..	●	16.5	25	34	126	48	70	56	0.5	17.5			
ATUM 17XD3 KDR 0602..	●	17	25	34	129	51	73	56	0.5	18	SPMT 090308 XOMT 090305	3008-M3x7	82-T15
ATUM 17.5XD3 KDR 0602..	●	17.5	25	34	129	51	73	56	0.5	18.5			
ATUM 18XD3 KDR 0602..	●	18	25	34	132	54	76	56	0.5	19	SPMT 11T308 XOMT 11T306	4015-M3.5x9	80-T15
ATUM 18.5XD3 KDR 0602..	●	18.5	25	34	132	54	76	56	0.5	19.5			
ATUM 19XD3 KDR 0602..	●	19	25	34	135	57	79	56	0.5	20	SPMT 130410 XOMT 130406	4015-M4x11	
ATUM 19.5XD3 KDR 0602..	●	19.5	25	34	135	57	79	56	0.5	20.5			
ATUM 20XD3 KDR 07T2..	●	20	25	34	138	60	82	56	0.3	20.6	SPMT 130410 XOMT 130406	4015-M4x11	
ATUM 20.5XD3 KDR 07T2..	●	20.5	25	34	138	60	82	56	0.3	21.1			
ATUM 21XD3 KDR 07T2..	●	21	25	34	141	63	85	56	0.3	21.6	SPMT 130410 XOMT 130406	4015-M4x11	
ATUM 22XD3 KDR 07T2..	●	22	25	34	144	66	88	56	0.3	22.6			
ATUM 22.5XD3 KDR 07T2..	●	22.5	25	34	144	68	88	56	0.3	23.1	SPMT 130410 XOMT 130406	4015-M4x11	
ATUM 23XD3 KDR 07T2..	●	23	25	34	147	69	91	56	0.3	23.6			
ATUM 23.5XD3 KDR 07T2..	●	23.5	25	34	147	69	91	56	0.3	24.1	SPMT 130410 XOMT 130406	4015-M4x11	
ATUM 24XD3 KDR 0903..	●	24	25	34	150	72	94	56	0.3	24.6			
ATUM 24.5XD3 KDR 0903..	●	24.5	25	34	150	72	94	56	0.3	25.1	SPMT 130410 XOMT 130406	4015-M4x11	
ATUM 25XD3 KDR 0903..	●	25	25	34	153	75	97	56	0.3	25.6			
ATUM 26XD3 KDR 0903..	●	26	25	34	156	78	100	56	0.3	26.6	SPMT 130410 XOMT 130406	4015-M4x11	
ATUM 27XD3 KDR 0903..	●	27	25	34	159	81	103	56	0.3	27.6			
ATUM 28XD3 KDR 0903..	●	28	25	34	162	84	106	56	0.3	28.6	SPMT 130410 XOMT 130406	4015-M4x11	
ATUM 29XD3 KDR 0903..	●	29	25	34	165	87	109	56	0.3	29.6			
ATUM 30XD3 KDR 11T3..	●	30	32	44	177	90	117	60	0.35	30.7	SPMT 130410 XOMT 130406	4015-M4x11	
ATUM 32XD3 KDR 11T3..	●	32	32	44	183	96	123	60	0.35	32.7			
ATUM 33XD3 KDR 11T3..	●	33	32	44	186	99	126	60	0.35	33.7	SPMT 130410 XOMT 130406	4015-M4x11	
ATUM 34XD3 KDR 11T3..	●	34	32	44	189	102	129	60	0.35	34.7			
ATUM 35XD3 KDR 11T3..	●	35	32	44	192	105	132	60	0.35	35.7	SPMT 130410 XOMT 130406	4015-M4x11	
ATUM 37XD3 KDR 1304..	●	37	32	44	198	111	138	60	0.35	37.7			
ATUM 38XD3 KDR 1304..	●	38	32	44	201	114	141	60	0.35	38.7	SPMT 130410 XOMT 130406	4015-M4x11	
ATUM 39XD3 KDR 1304..	●	39	32	44	204	117	144	60	0.35	39.7			
ATUM 40XD3 KDR 1304..	●	40	32	44	207	120	147	60	0.35	40.7	SPMT 130410 XOMT 130406	4015-M4x11	
ATUM 40XD3 KDR 1304..	●	40	32	44	207	120	147	60	0.35	40.7			

R: Sağ / Right / Rechts/ L: Sol / Left / Links

● Stokta / In Stock / Auf Lager ○ Stokta Yok / Non Stock Item / Kein Lagerartikel, Lieferzeit auf Anfrage

KRLY Ucuna Uygundur. / Compatible with KRLY Insert. / Kompatibel mit KRLY Wendeplatten.

Sipariş Örneği/Ordering Example/Bestellbeispiel

1 ad./pcs./stück ATUM 12.5XD3 KDR 0402..

Takma Uçlu Matkap Kullanım Kılavuzu : S 427 / User's Guide For U-Drills : P 427

Bedienungsanleitung für Vollbohrer : S 427



Delme Derinliği
Drilling Depth
Bohrtiefe

= 5x Çap
= 5x Diameter
= 5x Durchmesser

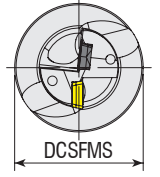
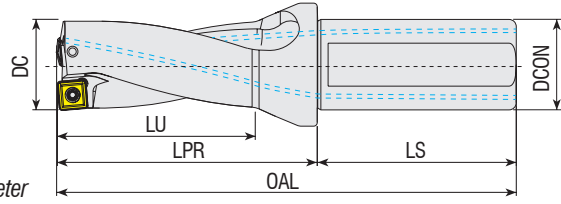

Takım Kodu Ordering Code Bestell-Bezeichnung	Stok Stock Lager	Takım Ölçüleri (mm) Dimension (mm) Abmessung (mm)							Maks. Ofset (radyal) Max. Offset (radial) Max. Versatz (radial)		Kesici Uç Insert Wendeschneidplatte	Yedek Parçaları / Spare Parts / Ersatzteile	
		DC	DCON	DCSFMS	OAL	LU	LPR	LS	X _{max}	DC _{max}		Sıkma Vidası Screw Schraube	Tork Anahtar Torx Key Torx-Schlüssel
ATUM 17XD5 KDR 0602..	●	17	25	34	163	85	107	56	0.5	18	SPMT 060205 XOMT 060204	3007-M2.2X4.6	82-T07
ATUM 17.5XD5 KDR 0602..	●	17.5	25	34	163	85	107	56	0.5	18.5			
ATUM 22XD5 KDR 07T2.	●	22	25	34	188	110	132	56	0.3	22.6	SPMT 07T208 XOMT 07T205 SPMT 11T308 XOMT 11T306	3008-M2.5X6	82-T08
ATUM 30XD5 KDR 11T3..	●	30	32	44	237	150	177	60	0.35	30.7			

KRLY Ucuna Uygundur. / Compatible with KRLY Insert. / Kompatibel mit KRLY Wendeplatten.

Takma Uçlu Matkap Kullanım Kılavuzu : S 427 / User's Guide For U-Drills : P 427
Bedienungsanleitung für Vollbohrer : S 427





Delme Derinliği
Drilling Depth
Bohrtiefe

= 2x Çap
= 2x Diameter
= 2x Durchmesser

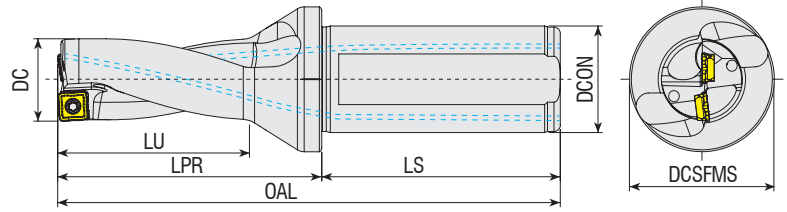

Takım Kodu
Ordering Code
Bestell-Bezeichnung

Stok
Stock
Lager

Takım Ölçüleri (mm)
Dimension (mm)
Abmessung (mm)

Maks. Ofset (radyal)
Max. Offset (radial)
Max. Versatz (radial)

Kesici Uç
Insert
Wendeschneidplatte

Yedek Parçaları / Spare Parts / Ersatzteile

Sıkma Vidası
Screw
Schraube

Tork Anahtar
Torx Key
Torx-Schlüssel

ATUM	DC	DCON	DCSFMS	OAL	LU	LPR	LS	X _{max} [mm]	DC _{max} [mm]	Kesici Uç	Sıkma Vidası	Tork Anahtar
14XD2 SO.. 052704	14	20	25	100	28	50	50	0.60	15.20	SOMX 052704	3006-M2x4.7	82-T08
15XD2 SO.. 052704	15	20	25	102	30	52	50	0.35	15.70			
16XD2 SO.. 052704	16	25	34	110	32	54	56	0.25	16.50	SOMX 063005	3008-M2.5X6	82-T08
17XD2 SO.. 063005	17	25	34	112	34	56	56	0.50	18.00			
18XD2 SO.. 063005	18	25	34	114	36	58	56	0.40	18.80	SOMX 073505	4010-M3X6	82-T10
19XD2 SO.. 063005	19	25	34	116	38	60	56	0.30	19.60			
20XD2 SO.. 073505	20	25	34	118	40	62	56	0.60	21.20	SOMX 084005	3010-M3.5X7	82-T10
21XD2 SO.. 073505	21	25	34	120	42	64	56	0.50	22.00			
22XD2 SO.. 073505	22	25	34	122	44	66	56	0.40	22.80	SOMX 094506	4015-M4X8	80-T15
23XD2 SO.. 084005	23	25	34	124	46	68	56	0.80	24.60			
24XD2 SO.. 084005	24	25	34	126	48	70	56	0.70	25.40	SOMX 166508	1020-M5X14	80-T20
25XD2 SO.. 084005	25	25	34	128	50	72	56	0.60	26.20			
26XD2 SO.. 084005	26	25	34	130	52	74	56	0.50	27.00	SOMX 094506	4015-M4X8	80-T15
28XD2 SO.. 094506	28	25	34	134	56	78	56	0.85	29.70			
30XD2 SO.. 094506	30	32	44	147	60	87	60	0.65	31.30	SOMX 166508	1020-M5X14	80-T20
48XD2 SO.. 166508	48	40	54	198	96	128	70	1.8	51.6			
55XD2 SO.. 166508	55	40	54	212	110	142	70	1.1	57.2	SOMX 166508	1020-M5X14	80-T20
new												

R: Sağ / Right / Rechts/ L: Sol / Left / Links

● Stokta / In Stock / Auf Lager ○ Stokta Yok / Non Stock Item / Kein Lagerartikel, Lieferzeit auf Anfrage

MTSBH Ucuna Uygundur. / Compatible with MTSBH Insert. / Kompatibel mit MTSBH Wendeplatten.

Sipariş Örneği/Ordering Example/Bestellbeispiel

1 ad./pcs./шт. ATUM 14XD2 SO.. 052704

Takma Uçlu Matkap Kullanım Kılavuzu : S 427 / User's Guide For U-Drills : P 427

Bedienungsanleitung für Vollbohrer : S 427



Delme Derinliği
Drilling Depth
Bohrtiefe

= 3x Çap
= 3x Diameter
= 3x Durchmesser

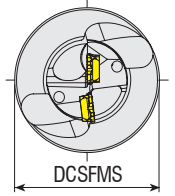
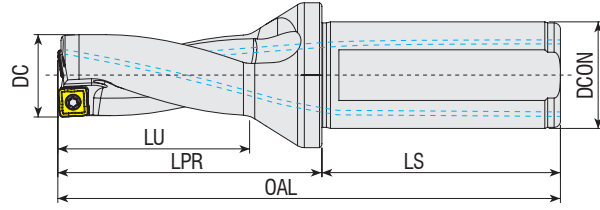

Takım Kodu
Ordering Code
Bestell-Bezeichnung

Stok
Stock
Lager

Takım Ölçüleri (mm)
Dimension (mm)
Abmessung (mm)

Maks. Ofset (radyal)
Max. Offset (radial)
Max. Versatz (radial)

Kesici Uç
Insert
Wendeschneidplatte

Yedek Parçaları / Spare Parts / Ersatzteile

Sıkma Vidası
Screw
Schraube

Tork Anahtar
Torx Key
Torx-Schlüssel

Takım Kodu Ordering Code Bestell-Bezeichnung	Stok Stock Lager	Takım Ölçüleri (mm) Dimension (mm) Abmessung (mm)								Maks. Ofset (radyal) Max. Offset (radial) Max. Versatz (radial)		Kesici Uç Insert Wendeschneidplatte	Sıkma Vidası Screw Schraube	Tork Anahtar Torx Key Torx-Schlüssel
		DC	DCON	DCSFMS	OAL	LU	LPR	LS	X _{max}	DC _{max}				
ATUM 14XD3 SO.. 052704	●	14	20	25	114	42	64	50	0.60	15.2	SOMX 052704	3006-M2x4.7	82-T08	
ATUM 14.5XD3 SO.. 052704	●	14.5	20	25	114	43.5	64	50	0.50	15.5				
ATUM 15XD3 SO.. 052704	●	15	20	25	117	45	67	50	0.35	15.7				
ATUM 15.5XD3 SO.. 052704	●	16.5	25	34	126	46.5	70	56	0.25	17.0				
ATUM 16XD3 SO.. 052704	●	16	25	34	126	48	70	56	0.25	16.5				
ATUM 16.5XD3 SO.. 052704	●	16.5	25	34	126	49.5	70	56	0.25	17.0				
ATUM 17XD3 SO.. 063005	●	17	25	34	129	51	73	56	0.50	18.0	SOMX 063005	3008-M2.5X6	82-T08	
ATUM 17.5XD3 SO.. 063005	●	17.5	25	34	129	52.5	73	56	0.45	18.4				
ATUM 18XD3 SO.. 063005	●	18	25	34	132	54	76	56	0.40	18.8				
ATUM 18.5XD3 SO.. 063005	●	18.5	25	34	132	55.5	76	56	0.35	19.2				
ATUM 19XD3 SO.. 063005	●	19	25	34	135	57	79	56	0.30	19.6				
ATUM 19.5XD3 SO.. 063005	●	19.5	25	34	135	58.5	79	56	0.25	20.0				
ATUM 20XD3 SO.. 073505	●	20	25	34	138	60	82	56	0.60	21.2	SOMX 073505	4010-M3X6	82-T10	
ATUM 20.5XD3 SO.. 073505	●	20.5	25	34	138	61.5	82	56	0.55	21.6				
ATUM 21XD3 SO.. 073505	●	21	25	34	141	63	85	56	0.50	22.0				
ATUM 21.5XD3 SO.. 073505	●	21.5	25	34	141	64.5	85	56	0.45	22.4				
ATUM 22XD3 SO.. 073505	●	22	25	34	144	66	88	56	0.40	22.8				
ATUM 22.5XD3 SO.. 073505	●	22.5	25	34	144	67.5	88	56	0.35	23.2				
ATUM 23XD3 SO.. 084005	●	23	25	34	147	69	91	56	0.80	24.6	SOMX 084005	3010-M3.5X7	82-T10	
ATUM 23.5XD3 SO.. 084005	●	23.5	25	34	147	70.5	91	56	0.75	25.0				
ATUM 24XD3 SO.. 084005	●	24	25	34	150	72	94	56	0.70	25.4				
ATUM 24.5XD3 SO.. 084005	●	24.5	25	34	150	73.5	94	56	0.65	25.8				
ATUM 25XD3 SO.. 084005	●	25	25	34	153	75	97	56	0.60	26.2				
ATUM 26XD3 SO.. 084005	●	26	25	34	156	78	100	56	0.50	27				
ATUM 27XD3 SO.. 084005	●	27	25	34	159	81	103	56	0.45	27.9	SOMX 094506	4015-M4X8	80-T15	
ATUM 28XD3 SO.. 094506	●	28	25	34	162	84	106	56	0.85	29.7				
ATUM 29XD3 SO.. 094506	●	29	25	34	165	87	109	56	0.75	30.5				
ATUM 30XD3 SO.. 094506	●	30	32	44	177	90	117	60	0.65	31.3				
ATUM 32XD3 SO.. 094506	●	32	32	44	183	96	123	60	0.45	32.9				

R: Sağ / Right / Rechts L: Sol / Left / Links

● Stokta / In Stock / Auf Lager ○ Stokta Yok / Non Stock Item / Kein Lagerartikel, Lieferzeit auf Anfrage

MTSBH Ucuna Uygundur. / Compatible with MTSBH Insert. / Kompatibel mit MTSBH Wendeplatten.

Sipariş Örneği/Ordering Example/Bestellbeispiel

1 ad./pcs./stück ATUM 14XD3 SO.. 052704

Takma Uçlu Matkap Kullanım Kılavuzu : S 427 / User's Guide For U-Drills : P 427

Bedienungsanleitung für Vollbohrer : S 427



Delme Derinliği
Drilling Depth
Bohrtiefe

= 4x Çap
= 4x Diameter
= 4x Durchmesser

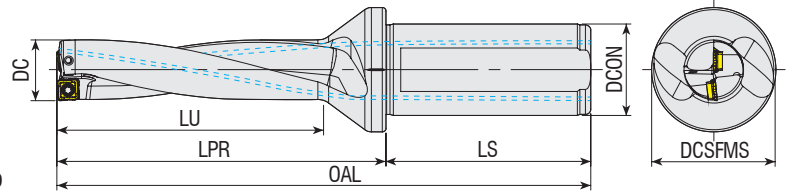

Takım Kodu
Ordering Code
Bestell-Bezeichnung

Stok
Stock
Lager

Takım Ölçüleri (mm)
Dimension (mm)
Abmessung (mm)

Maks. Ofset (radyal)
Max. Offset (radial)
Max. Versatz (radial)

Kesici Uç
Insert
Wendeschneidplatte

Yedek Parçaları / Spare Parts / Ersatzteile

Sıkma Vidası
Screw
Schraube

Tork Anahtar
Torx Key
Torx-Schlüssel

ATUM	Model	SO..	Part No.	Stok Durumu	DC	DCON	DCSFMS	OAL	LU	LPR	LS	Maks. Ofset (radyal)		Kesici Uç	Sıkma Vidası	Tork Anahtar
												X_{max}	DC_{max}			
ATUM	14XD4	SO..	052704	●	14	20	25	128	56	78	50	0.60	15.2	SOMX 052704	3006-M2x4.7	82-T08
ATUM	15XD4	SO..	052704	●	15	20	25	132	60	82	50	0.35	15.7			
ATUM	16XD4	SO..	052704	●	16	25	34	142	64	86	56	0.25	16.5	SOMX 063005	3008-M2.5X6	82-T08
ATUM	17XD4	SO..	063005	●	17	25	34	146	68	90	56	0.50	18.0			
ATUM	18XD4	SO..	063005	●	18	25	34	150	72	94	56	0.40	18.8	SOMX 063005	3008-M2.5X6	82-T08
ATUM	19XD4	SO..	063005	●	19	25	34	154	76	98	56	0.30	19.6			
ATUM	20XD4	SO..	073505	●	20	25	34	158	80	102	56	0.60	21.2	SOMX 073505	4010-M3X6	82-T10
ATUM	21XD4	SO..	073505	●	21	25	34	162	84	106	56	0.50	22.0			
ATUM	22XD4	SO..	073505	●	22	25	34	166	88	110	56	0.40	22.8	SOMX 084005	3010-M3.5X7	82-T10
ATUM	23XD4	SO..	084005	●	23	25	34	170	92	114	56	0.80	24.6			
ATUM	24XD4	SO..	084005	●	24	25	34	174	96	118	56	0.70	25.4	SOMX 084005	3010-M3.5X7	82-T10
ATUM	25XD4	SO..	084005	●	25	25	34	178	100	122	56	0.60	26.2			
ATUM	26XD4	SO..	084005	●	26	25	34	182	104	126	56	0.50	27.0	SOMX 094506	4015-M4X8	80-T15
ATUM	28XD4	SO..	094506	●	28	25	34	190	112	134	56	0.85	29.7			
ATUM	30XD4	SO..	094506	●	30	32	44	207	120	147	60	0.65	31.3			

R: Sağ / Right / Rechts/ L: Sol / Left / Links

● Stokta / In Stock / Auf Lager ○ Stokta Yok / Non Stock Item / Kein Lagerartikel, Lieferzeit auf Anfrage

MTSBH Ucuna Uygun. / Compatible with MTSBH Insert. / Kompatibel mit MTSBH Wendeplatten.

Sipariş Örneği/Ordering Example/Bestellbeispiel

1 ad./pcs./stück ATUM 14XD4 SO.. 052704

Takma Uçlu Matkap Kullanım Kılavuzu : S 427 / User's Guide For U-Drills : P 427

Bedienungsanleitung für Vollbohrer : S 427



Delme Derinliği
Drilling Depth
Bohrtiefe
= 3x Çap
= 3x Diameter
= 3x Durchmesser

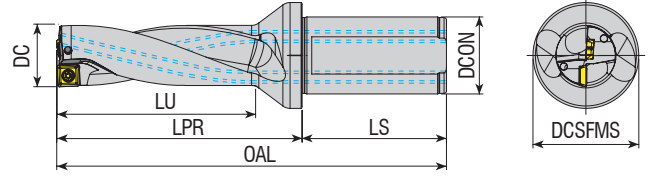

Takım Kodu Ordering Code Bestell-Bezeichnung	Stok Stock Lager	Takım Ölçüleri (mm) Dimension (mm) Abmessung (mm)								Maks. Ofset (radyal) Max. Offset (radial) Max. Versatz (radial)		Kesici Uç Insert Wendeschneidplatte	Yedek Parçaları / Spare Parts / Ersatzteile	
		DC	DCON	DCSFMS	OAL	LU	LPR	LS	X _{max}	DC _{max}	Sıkma Vidası Screw Schraube		Tork Anahtar Torx Key Torx-Schlüssel	
ATUM 14XD3 880-0202..	●	14	20	25	108	42	58	50	0.5	15	880-02...C / P	3006-M2x4	82-T06	
ATUM 14.5XD3 880-0202..	●	14.5	20	25	110	46	60	50	0.45	15.4				
ATUM 15XD3 880-0202..	●	15	20	25	112	48	62	50	0.4	15.8				
ATUM 15.5XD3 880-0202..	●	15.5	20	25	114	50	64	50	0.3	16.1				
ATUM 16XD3 880-0202..	●	16	20	25	116	51	66	50	0.3	16.6				
ATUM 16.5XD3 880-0303..	●	16.5	20	25	118	53	68	50	0.6	17.7				
ATUM 17XD3 880-0303..	●	17	20	25	119	54	69	50	0.6	18.2				
ATUM 17.5XD3 880-0303..	●	17.5	25	32	128	56	72	56	0.5	18.5				
ATUM 18XD3 880-0303..	●	18	25	32	129	57	73	56	0.4	18.8				
ATUM 18.5XD3 880-0303..	●	18.5	25	32	131	59	75	56	0.4	19.3				
ATUM 19XD3 880-0303..	●	19	25	32	132	60	76	56	0.3	19.6				
ATUM 19.5XD3 880-0303..	●	19.5	25	32	135	62	79	56	0.3	20.1				
ATUM 20XD3 880-0403..	●	20	25	32	137	64	81	56	0.9	21.8				
ATUM 20.5XD3 880-0403..	●	20.5	25	32	138	65	82	56	0.8	22.1				
ATUM 21XD3 880-0403..	●	21	25	32	140	66	84	56	0.8	22.6				
ATUM 21.5XD3 880-0403..	●	21.5	25	32	142	68	86	56	0.7	22.9				
ATUM 22XD3 880-0403..	●	22	25	32	143	69	87	56	0.6	23.2				
ATUM 22.5XD3 880-0403..	●	22.5	25	32	146	71	90	56	0.5	23.5				
ATUM 23XD3 880-0403..	●	23	25	32	147	72	91	56	0.5	24				
ATUM 23.5XD3 880-0403..	●	23.5	25	34	149	69	93	56	0.4	24.3				
ATUM 24XD3 880-0503..	●	24	25	32	151	76	95	56	1.1	26.2				
ATUM 25XD3 880-0503..	●	25	25	32	155	79	99	56	1	27				
ATUM 26XD3 880-0503..	●	26	32	44	162	81	102	60	0.9	27.8				
ATUM 27XD3 880-0503..	●	27	32	44	165	84	105	60	0.7	28.4				
ATUM 28XD3 880-0503..	●	28	32	44	169	87	109	60	0.6	29.2				
ATUM 29XD3 880-0503..	●	29	32	44	172	90	112	60	0.5	30				
ATUM 30XD3 880-0604..	●	30	32	44	177	94	117	60	1.1	32.2				
ATUM 31XD3 880-0604..	●	31	40	54	191	97	121	70	1	33				
ATUM 32XD3 880-0604..	●	32	40	54	194	100	124	70	0.9	33.8				
ATUM 33XD3 880-0604..	●	33	40	54	198	103	128	70	0.7	34.4				
ATUM 34XD3 880-0604..	●	34	40	54	201	106	131	70	0.5	35				
ATUM 35XD3 880-0604..	●	35	40	54	205	109	135	70	0.4	35.8				
ATUM 36XD3 880-0704..	●	36	40	54	209	112	139	70	1.3	38.6				
ATUM 38XD3 880-0704..	●	38	40	54	216	118	146	70	1.1	40.2				
ATUM 39XD3 880-0704..	●	39	40	54	219	121	149	70	1	41				
ATUM 40XD3 880-0704..	●	40	40	54	223	124	153	70	0.8	41.6				
ATUM 41XD3 880-0704..	●	41	40	54	227	127	157	70	0.7	42.4				
ATUM 42XD3 880-0704..	●	42	40	54	230	130	160	70	0.6	43.2				
ATUM 45XD3 880-0805..	●	45	40	54	242	140	172	70	1.4	47.8				
ATUM 46XD3 880-0805..	●	46	40	54	246	143	176	70	1.3	48.6				
ATUM 48XD3 880-0805..	●	48	40	54	253	149	183	70	1	50				
ATUM 50XD3 880-0805..	●	50	40	54	260	155	190	70	0.8	51.6				

R: Sağ / Right / Rechts L: Sol / Left / Links

● Stokta / In Stock / Auf Lager ○ Stokta Yok / Non Stock Item / Kein Lagerartikel, Lieferzeit auf Anfrage

SNDVK Ucuna Uygundur. / Compatible with SNDVK Insert. / Kompatibel mit SNDVK Wendeplatten.

Sipariş Örneği/Ordering Example/Bestellbeispiel

1 ad./pcs./stück ATUM 14XD3 880-0202..

Takma Uçlu Matkap Kullanım Kılavuzu : S 427 / User's Guide For U-Drills : P 427
Bedienungsanleitung für Vollbohrer : S 427



Delme Derinliği
Drilling Depth
Bohrtiefe

= 2x Çap
= 2x Diameter
= 2x Durchmesser

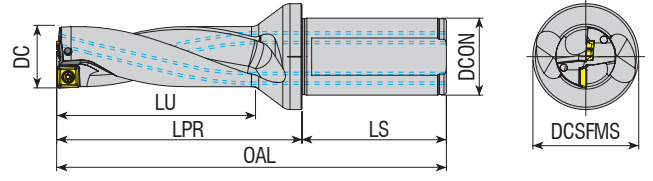

Takım Kodu Ordering Code Bestell-Bezeichnung	Stok Stock Lager	Takım Ölçüleri (mm) Dimension (mm) Abmessung (mm)							Maks. Ofset (radyal) Max. Offset (radial) Max. Versatz (radial)		Kesici Uç Insert Wendescheidplatte	Yedek Parçaları / Spare Parts / Ersatzteile	
		DC	DCON	DCSFMS	OAL	LU	LPR	LS	X_{max}	DC_{max}		Sıkma Vidası Screw Schraube	Tork Anahtar Torx Key Torx-Schlüssel
ATUM 25.5xD2 880-0503..	●	25.5	25	32	131	50	75	56	0.25	26	880-05...C/P	4010-M3X8	82-T10
ATUM 28.5xD2 880-0503..	●	28.5	32	44	143	56	83	60	0.25	29			
ATUM 32xD2 880-0604..	●	32	40	54	162	64	92	70	0.25	32.5	880-06...C/P	3010-M3.5X9	
ATUM 35xD2 880-0604..	●	35	40	54	171	70	101	70	0.25	35.5			



Delme Derinliği
Drilling Depth
Bohrtiefe

= 5x Çap
= 5x Diameter
= 5x Durchmesser

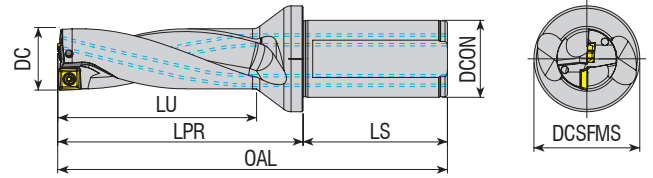

Takım Kodu Ordering Code Bestell-Bezeichnung	Stok Stock Lager	Takım Ölçüleri (mm) Dimension (mm) Abmessung (mm)							Maks. Ofset (radyal) Max. Offset (radial) Max. Versatz (radial)		Kesici Uç Insert Wendescheidplatte	Yedek Parçaları / Spare Parts / Ersatzteile	
		DC	DCON	DCSFMS	OAL	LU	LPR	LS	X_{max}	DC_{max}		Sıkma Vidası Screw Schraube	Tork Anahtar Torx Key Torx-Schlüssel
ATUM 17.5xD5 880-0303..	●	17.5	25	32	163	85	107	56	0.25	18	880-03...C/P	3007-M2.2X4.6	82-T07

R: Sağ / Right / Rechts/ L: Sol / Left / Links
● Stokta / In Stock / Auf Lager ○ Stokta Yok / Non Stock Item / Kein Lagerartikel, Lieferzeit auf Anfrage
SNDVK Ucuna Uygundur. / Compatible with SNDVK Insert. / Kompatibel mit SNDVK Wendeplatten.

Sipariş Örneği/Ordering Example/Bestellbeispiel
1 ad./pcs./stück ATUM 25.5xD2 880-0503..
Takma Uçlu Matkap Kullanım Kılavuzu : S 427 / User's Guide For U-Drills : P 427
Bedienungsanleitung für Vollbohrer : S 427

TGTC Ucuna Uygundur. / Compatible with TGTC Insert. / Kompatibel mit TGTC Wendeplatten.



Delme Derinliği
Drilling Depth
Bohrtiefe

= 2x Çap
= 2x Diameter
= 2x Durchmesser

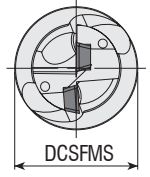
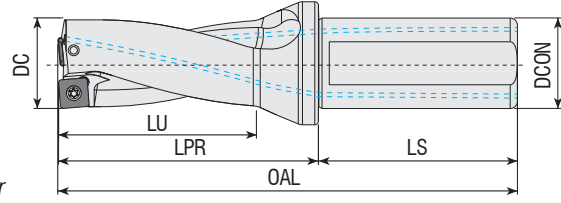

Takım Kodu
Ordering Code
Bestell-Bezeichnung

Stok
Stock
Lager

Takım Ölçüleri (mm)
Dimension (mm)
Abmessung (mm)

Maks. Ofset (radyal)
Max. Offset (radial)
Max. Versatz (radial)

Kesici Uç
Insert
Wendeschneidplatte

Yedek Parçaları / Spare Parts / Ersatzteile

Sıkma Vidası
Screw
Schraube

Tork Anahtar
Torx Key
Torx-Schlüssel

Takım Kodu Ordering Code Bestell-Bezeichnung	Stok Stock Lager	Takım Ölçüleri (mm) Dimension (mm) Abmessung (mm)							Maks. Ofset (radyal) Max. Offset (radial) Max. Versatz (radial)		Kesici Uç Insert Wendeschneidplatte	Sıkma Vidası Screw Schraube	Tork Anahtar Torx Key Torx-Schlüssel
		DC	DCON	DCSFMS	OAL	LU	LPR	LS	X _{max} X _{max} [mm]	DC _{max} DC _{max} [mm]			
ATUM 12.5XD2 SP.. 050204	●	12.5	20	25	96	24	46	50	0.75	14	SP.. 050204	3006-M2x4	82-T06
ATUM 13XD2 SP.. 050204	●	13	20	25	98	26	48	50	0.75	14.5			
ATUM 13.5XD2 SP.. 050204	●	13.5	20	25	98	26	48	50	0.75	15			
ATUM 14XD2 SP.. 050204	●	14	20	25	100	28	50	50	0.6	15.2			
ATUM 14.5XD2 SP.. 050204	●	14.5	20	25	100	28	50	50	0.6	15.7			
ATUM 15XD2 SP.. 050204	●	15	20	25	102	30	52	50	0.5	16			
ATUM 15.5XD2 SP.. 060204	●	15.5	20	25	102	30	52	50	0.9	17.3	SP.. 060204	3007-M2.2x4.6	82-T07
ATUM 16XD2 SP.. 060204	●	16	25	34	110	32	54	56	0.8	17.6			
ATUM 16.5XD2 SP.. 060204	●	16.5	25	34	110	32	54	56	0.8	18.1			
ATUM 17XD2 SP.. 060204	●	17	25	34	112	34	56	56	0.75	18.5			
ATUM 17.5XD2 SP.. 060204	●	17.5	25	34	112	34	56	56	0.75	19			
ATUM 18XD2 SP.. 060204	●	18	25	34	114	36	58	56	0.5	19			
ATUM 18.5XD2 SP.. 060204	●	18.5	25	34	114	36	58	56	0.5	19.5			
ATUM 19XD2 SP.. 060204	●	19	25	34	116	38	60	56	0.3	19.6			
ATUM 19.5XD2 SP.. 060204	●	19.5	25	34	116	38	60	56	0.3	20.1			
ATUM 20XD2 SP.. 060204	●	20	25	34	118	40	62	56	0	20			
ATUM 20.5XD2 SP.. 060204	●	20.5	25	34	118	40	62	56	0	20.5			
ATUM 21XD2 SP.. 060204	●	21	25	34	120	42	64	56	0	21			
ATUM 21.5XD2 SP.. 060204	●	21.5	25	34	120	42	64	56	0	21.5			
ATUM 22XD2 SP.. 07T308	●	22	25	34	122	44	66	56	1	24	SP.. 07T308	3008-M2.5x6	82-T08
ATUM 22XD2 SP.. 07T308-32	●	22	32	44	131	44	71	60	1	24			
ATUM 22.5XD2 SP.. 07T308	●	22.5	25	34	122	44	66	56	1	24.5	SP.. 07T308	3008-M2.5x6	82-T08
ATUM 23XD2 SP.. 07T308	●	23	25	34	124	46	68	56	0.75	24.5			
ATUM 23XD2 SP.. 07T308-32	●	23	32	44	133	46	73	60	0.75	24.5			
ATUM 23.5XD2 SP.. 07T308	●	23.5	25	34	124	46	68	56	0.75	25			
ATUM 24XD2 SP.. 07T308	●	24	25	34	126	48	70	56	0.5	25			
ATUM 24XD2 SP.. 07T308-32	●	24	32	44	135	48	75	60	0.50	25			
ATUM 24.5XD2 SP.. 07T308	●	24.5	25	34	126	48	70	56	0.5	25.5			
ATUM 25XD2 SP.. 07T308	●	25	25	34	128	50	72	56	0.25	25.5			
ATUM 25XD2 SP.. 07T308-32	●	25	32	44	137	50	77	60	0.25	25.5			
ATUM 25.5XD2 SP.. 07T308	●	25.5	25	34	128	50	72	56	0.25	26			
ATUM 26XD2 SP.. 07T308	●	26	25	34	130	52	74	56	0	26			
ATUM 26XD2 SP.. 07T308-32	●	26	32	44	139	52	79	60	0	26			
ATUM 26.5XD2 SP.. 07T308	●	26.5	25	34	130	52	74	56	0	26.5			
ATUM 27XD2 SP.. 07T308	●	27	25	34	132	54	76	56	0	27			
ATUM 27XD2 SP.. 07T308-32	●	27	32	44	141	54	81	60	0	27			
ATUM 27.5XD2 SP.. 07T308	●	27.5	25	34	132	54	76	56	0	27.5			

R: Sağ / Right / Rechts/ L: Sol / Left / Links

● Stokta / In Stock / Auf Lager ○ Stokta Yok / Non Stock Item / Kein Lagerartikel, Lieferzeit auf Anfrage

TGTC Ucuna Uygundur. / Compatible with TGTC Insert. / Kompatibel mit TGTC Wendeplatten.

Sipariş Örneği/Ordering Example/Bestellbeispiel

1 ad./pcs./stück ATUM 12.5XD2 SP.. 050204

Takma Uçlu Matkap Kullanım Kılavuzu : S 427 / User's Guide For U-Drills : P 427

Bedienungsanleitung für Vollbohrer : S 427



Delme Derinliği
Drilling Depth
Bohrtiefe

= 2x Çap
= 2x Diameter
= 2x Durchmesser

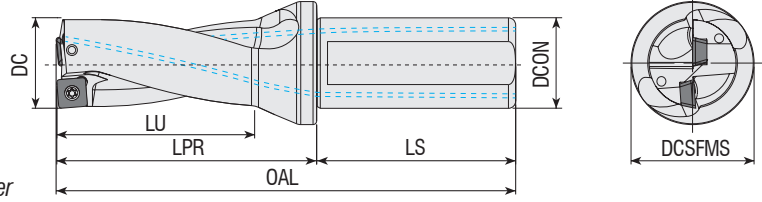

Takım Kodu
Ordering Code
Bestell-Bezeichnung

Stok
Stock
Lager

Takım Ölçüleri (mm)
Dimension (mm)
Abmessung (mm)

Maks. Ofset (radyal)
Max. Offset (radial)
Max. Versatz (radial)

Kesici Uç
Insert
Wendeschneidplatte

Yedek Parçaları / Spare Parts / Ersatzteile

Sıkma Vidası
Screw
Schraube

Tork Anahtar
Torx Key
Torx-Schlüssel

Takım Kodu Ordering Code Bestell-Bezeichnung	Stok Stock Lager	DC	DCON	DCSEMS	OAL	LU	LPR	LS	X _{max} X _{max} [mm]	DC _{max} DC _{max} [mm]	Kesici Uç Insert Wendeschneidplatte	Sıkma Vidası Screw Schraube	Tork Anahtar Torx Key Torx-Schlüssel
ATUM 28XD2 SP. 090408	●	28	25	34	134	56	78	56	1	30	SP. 090408	4015-M3.5x9	80-T15
ATUM 28XD2 SP. 090408-32	●	28	32	44	143	56	83	60	1	29			
ATUM 28.5XD2 SP. 090408	●	28.5	25	34	134	56	78	56	1	30.5			
ATUM 29XD2 SP. 090408	●	29	25	34	136	58	80	56	0.75	30.5			
ATUM 29XD2 SP. 090408-32	●	29	32	44	145	58	85	60	0.75	30.5			
ATUM 29.5XD2 SP. 090408	●	29.5	25	34	136	58	80	56	0.75	31			
ATUM 30XD2 SP. 090408	●	30	32	44	147	60	87	60	0.5	31			
new ATUM 30.5XD2 SP. 090408	●	30.5	32	34	147	60	87	60	0.5	31.5			
ATUM 31XD2 SP. 090408	●	31	32	44	149	62	89	60	0.25	31.5			
ATUM 32XD2 SP. 090408	●	32	32	44	151	64	91	60	0	32			
ATUM 33XD2 SP. 090408	●	33	32	44	153	66	93	60	0	33			
ATUM 34XD2 SP. 110408	●	34	32	44	155	68	95	60	1	36	SP. 110408	4015-M4x11	80-T15
ATUM 35XD2 SP. 110408	●	35	32	44	157	70	97	60	0.75	36.5			
ATUM 36XD2 SP. 110408	●	36	32	44	159	72	99	60	0.6	37.2			
ATUM 37XD2 SP. 110408	●	37	32	44	161	74	101	60	0.5	38			
ATUM 38XD2 SP. 110408	●	38	32	44	163	76	103	60	0.25	38.5			
ATUM 39XD2 SP. 110408	●	39	32	44	165	78	105	60	0	39			
ATUM 40XD2 SP. 110408	●	40	32	44	167	80	107	60	0	40			
ATUM 41XD2 SP. 110408	●	41	32	44	169	82	109	60	0	41			
ATUM 42XD2 SP. 140512	●	42	32	44	171	84	111	60	1.2	44.4	SP. 140512	1020-M5x11	80-T20
ATUM 43XD2 SP. 140512	●	43	32	44	173	86	113	60	1	45			
ATUM 44XD2 SP. 140512	●	44	32	44	175	88	115	60	0.8	45.6			
ATUM 45XD2 SP. 140512	●	45	40	54	192	90	122	70	0.6	46.2			
ATUM 46XD2 SP. 140512	●	46	40	54	194	92	124	70	0.4	46.8			
ATUM 47XD2 SP. 140512	●	47	40	54	196	94	126	70	0.2	47.4			
ATUM 48XD2 SP. 140512	●	48	40	54	198	96	128	70	0	48			
ATUM 49XD2 SP. 140512	●	49	40	54	200	98	130	70	0	49			
ATUM 50XD2 SP. 140512	●	50	40	54	202	100	132	70	0	50			

R: Sağ / Right / Rechts/ L: Sol / Left / Links

● Stokta / In Stock / Auf Lager ○ Stokta Yok / Non Stock Item / Kein Lagerartikel, Lieferzeit auf Anfrage

TGTC Ucuna Uygundur. / Compatible with TGTC Insert. / Kompatibel mit TGTC Wendeplatten.

Sipariş Örneği/Ordering Example/Bestellbeispiel

1 ad./pcs./stück ATUM 28XD2 SP. 090408

Takma Uçlu Matkap Kullanım Kılavuzu : S 427 / User's Guide For U-Drills : P 427

Bedienungsanleitung für Vollbohrer : S 427

TGTC Ucuna Uygunur. / Compatible with TGTC Insert. / Kompatibel mit TGTC Wendeplatten.



Delme Derinliği = 3x Çap
Drilling Depth = 3x Diameter
Bohrtiefe = 3x Durchmesser

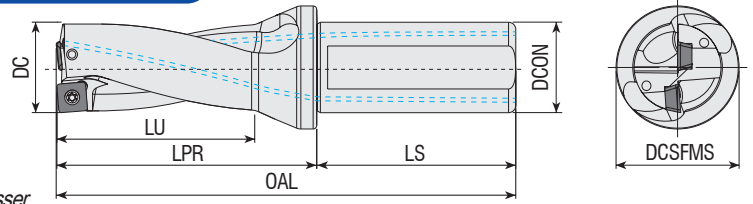

Takım Kodu
Ordering Code
Bestell-Bezeichnung

Stok
Stock
Lager

Takım Ölçüleri (mm)
Dimension (mm)
Abmessung (mm)

Maks. Offset (radyal)
Max. Offset (radial)
Max. Versatz (radial)

Kesici Uç
Insert
Wendeschneidplatte

Yedek Parçaları / Spare Parts / Ersatzteile

Sıkma Vidası
Screw
Schraube

Tork Anahtar
Torx Key
Torx-Schlüssel

Takım Kodu Ordering Code Bestell-Bezeichnung	Stok Stock Lager	Takım Ölçüleri (mm) Dimension (mm) Abmessung (mm)								Maks. Offset (radyal) Max. Offset (radial) Max. Versatz (radial)		Kesici Uç Insert Wendeschneidplatte	Yedek Parçaları / Spare Parts / Ersatzteile Sıkma Vidası Screw Schraube	Tork Anahtar Torx Key Torx-Schlüssel
		DC	DCON	DCSFMS	OAL	LU	LPR	LS	X _{max} [mm]	DC _{max} [mm]				
ATUM 12.5XD3 SP. 050204	●	12.5	20	25	108	36	58	50	0.75	14	SP. 050204	3006-M2x4	82-T06	
ATUM 13XD3 SP. 050204	●	13	20	25	111	39	61	50	0.75	14.5				
ATUM 13.5XD3 SP. 050204	●	13.5	20	25	111	39	61	50	0.75	15				
ATUM 14XD3 SP. 050204	●	14	20	25	114	42	64	50	0.6	15.2				
ATUM 14.5XD3 SP. 050204	●	14.5	20	25	114	42	64	50	0.6	15.7				
ATUM 15XD3 SP. 050204	●	15	20	25	117	45	67	50	0.5	16				
ATUM 15.5XD3 SP. 060204	●	15.5	20	25	117	45	67	50	0.9	17.3				
ATUM 16XD3 SP. 060204	●	16	25	34	126	48	70	56	0.8	17.6				
ATUM 16.5XD3 SP. 060204	●	16.5	25	34	126	48	70	56	0.8	18.1				
ATUM 17XD3 SP. 060204	●	17	25	34	129	51	73	56	0.75	18.5				
ATUM 17.5XD3 SP. 060204	●	17.5	25	34	129	51	73	56	0.75	19				
ATUM 18XD3 SP. 060204	●	18	25	34	132	54	76	56	0.5	19				
ATUM 18.5XD3 SP. 060204	●	18.5	25	34	132	54	76	56	0.5	19.5				
ATUM 19XD3 SP. 060204	●	19	25	34	135	57	79	56	0.3	19.6				
ATUM 19.5XD3 SP. 060204	●	19.5	25	34	135	57	79	56	0.3	20.1				
ATUM 20XD3 SP. 060204	●	20	25	34	138	60	82	56	0	20				
ATUM 20.5XD3 SP. 060204	●	20.5	25	34	138	60	82	56	0	20.5				
ATUM 21XD3 SP. 060204	●	21	25	34	141	63	85	56	0	21				
ATUM 21.5XD3 SP. 060204	●	21.5	25	34	141	63	85	56	0	21.5				
ATUM 22XD3 SP. 07T308	●	22	25	34	144	66	88	56	1	24				
ATUM 22XD3 SP. 07T308-32	●	22	32	44	153	66	93	60	1	23				
ATUM 22.5XD3 SP. 07T308	●	22.5	25	34	144	66	88	56	1	24.5				
ATUM 23XD3 SP. 07T308	●	23	25	34	147	69	91	56	0.75	24.5				
ATUM 23XD3 SP. 07T308-32	●	23	32	44	156	69	96	60	0.75	24.5				
ATUM 23.5XD3 SP. 07T308	●	23.5	25	34	147	69	91	56	0.75	25				
ATUM 24XD3 SP. 07T308	●	24	25	34	150	72	94	56	0.5	25				
ATUM 24XD3 SP. 07T308-32	●	24	32	44	159	72	99	60	0.50	25				
ATUM 24.5XD3 SP. 07T308	●	24.5	25	34	150	72	94	56	0.5	25.5				
ATUM 25XD3 SP. 07T308	●	25	25	34	153	75	97	56	0.25	25.5				
ATUM 25XD3 SP. 07T308-32	●	25	32	44	162	75	102	60	0.25	25.5				
ATUM 25.5XD3 SP. 07T308	●	25.5	25	34	153	75	97	56	0.25	26				
ATUM 26XD3 SP. 07T308	●	26	25	34	156	78	100	56	0	26				
ATUM 26XD3 SP. 07T308-32	●	26	32	44	165	78	105	60	0	26				
ATUM 26.5XD3 SP. 07T308	●	26.5	25	34	156	78	100	56	0	26.5				
ATUM 27XD3 SP. 07T308	●	27	25	34	159	81	103	56	0	27				
ATUM 27XD3 SP. 07T308-32	●	27	32	44	168	81	108	60	0	27				
ATUM 27.5XD3 SP. 07T308	●	27.5	25	34	159	81	103	56	0	27.5				
ATUM 28XD3 SP. 090408	●	28	25	34	162	84	106	56	1	30				
ATUM 28XD3 SP. 090408-32	●	28	32	44	171	84	111	60	1	29				
ATUM 28.5XD3 SP. 090408	●	28.5	25	34	162	84	106	56	1	30.5				
ATUM 29XD3 SP. 090408	●	29	25	34	165	87	109	56	0.75	30.5				
ATUM 29XD3 SP. 090408-32	●	29	32	44	174	87	114	6	0.75	30.5				
ATUM 29.5XD3 SP. 090408	●	29.5	25	34	165	87	109	56	0.75	31				
ATUM 30XD3 SP. 090408	●	30	32	44	177	90	117	60	0.5	31				
ATUM 30.5XD3 SP. 090408	●	30.5	32	44	177	90	117	60	0.5	31.5				
ATUM 31XD3 SP. 090408	●	31	32	44	180	93	120	60	0.25	31.5				
ATUM 31.5XD3 SP. 090408	●	31.5	32	44	180	93	120	60	0.25	32				
ATUM 32XD3 SP. 090408	●	32	32	44	183	96	123	60	0	32				
ATUM 32.5XD3 SP. 090408	●	32.5	32	44	183	96	123	60	0	32.5				
ATUM 33XD3 SP. 090408	●	33	32	44	186	99	126	60	0	33				
ATUM 33.5XD3 SP. 090408	●	33.5	32	44	186	99	126	60	0	33.5				

R: Sağ / Right / Rechts / L: Sol / Left / Links

● Stokta / In Stock / Auf Lager ○ Stokta Yok / Non Stock Item / Kein Lagerartikel, Lieferzeit auf Anfrage

TGTC Ucuna Uygunur. / Compatible with TGTC Insert. / Kompatibel mit TGTC Wendeplatten.

Sipariş Örneği/Ordering Example/Bestellbeispiel

1 ad./pcs./stück ATUM 12.5XD3 SP. 050204

Takma Uçlu Matkap Kullanım Kılavuzu : S 427 / User's Guide For U-Drills : P 427

Bedienungsanleitung für Vollbohrer : S 427



Delme Derinliği
Drilling Depth
Bohrtiefe
= 3x Çap
= 3x Diameter
= 3x Durchmesser

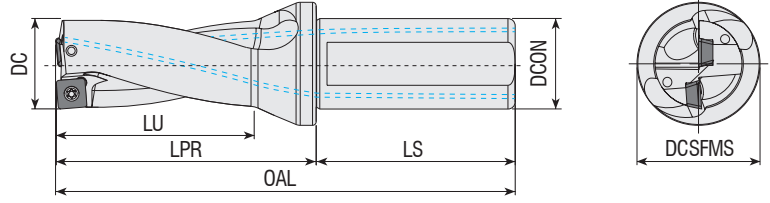

Takım Kodu
Ordering Code
Bestell-Bezeichnung

Stok Stock Lager	Takım Ölçüleri (mm) Dimension (mm) Abmessung (mm)							Maks. Ofset (radyal) Max. Offset (radial) Max. Versatz (radial)		Kesici Uç Insert Wendeschneidplatte	Yedek Parçaları / Spare Parts / Ersatzteile	
	DC	DCON	DCSFMS	OAL	LU	LPR	LS	X _{max}	DC _{max} [mm]		Sıkma Vidası Screw Schraube	Tork Anahtar Torx Key Torx-Schlüssel
●	34	32	44	189	102	129	60	1	36	SP. 110408	4015-M4x11	80-T15
●	34.5	32	44	189	102	129	60	1	36.5			
●	35	32	44	192	105	132	60	0.75	36.5			
●	35.5	32	44	192	105	132	60	0.75	37			
●	36	32	44	195	108	135	60	0.6	37.2			
●	36.5	32	44	195	108	135	60	0.6	37.7			
●	37	32	44	198	111	138	60	0.5	38			
●	37.5	32	44	198	111	138	60	0.5	38.5			
●	38	32	44	201	114	141	60	0.25	38.5			
●	38.5	32	44	201	114	141	60	0.25	39			
●	39	32	44	204	117	144	60	0	39			
●	39.5	32	44	204	117	144	60	0	39.5			
●	40	32	44	207	120	147	60	0	40			
●	40.5	32	44	207	120	147	60	0	40.5			
●	41	32	44	210	123	150	60	0	41			
●	41.5	32	44	210	123	150	60	0	41.5			
●	42	32	44	213	126	153	60	1.2	44.4	SP. 140512	1020-M5x11	80-T20
●	42.5	32	44	213	126	153	60	1.2	44.9			
●	43	32	44	216	129	156	60	1	45			
●	43.5	32	44	216	129	156	60	1	45.5			
●	44	32	44	219	132	159	60	0.8	45.6			
●	44.5	32	44	219	132	159	60	0.8	46.1			
●	45	40	54	237	135	167	70	0.6	46.2			
●	45.5	40	54	237	135	167	70	0.6	46.7			
●	46	40	54	240	138	170	70	0.4	46.8			
●	47	40	54	243	141	173	70	0.2	47.4			
●	48	40	54	246	144	176	70	0	48			
●	48.5	40	54	246	144	176	70	0	48.5			
●	49	40	54	249	147	179	70	0	49			
●	50	40	54	252	150	182	70	0	50			
●	51	40	54	255	153	185	70	0	51			
●	52	40	54	258	156	188	70	0	52			

R: Sağ / Right / Rechts/ L: Sol / Left / Links

● Stokta / In Stock / Auf Lager ○ Stokta Yok / Non Stock Item / Kein Lagerartikel, Lieferzeit auf Anfrage

TGTC Ucuna Uygundur. / Compatible with TGTC Insert. / Kompatibel mit TGTC Wendeplatten.

Sipariş Örneği/Ordering Example/Bestellbeispiel

1 ad./pcs./stück ATUM 34XD3 SP. 110408

Takma Uçlu Matkap Kullanım Kılavuzu : S 427 / User's Guide For U-Drills : P 427

Bedienungsanleitung für Vollbohrer : S 427

TGTC Ucuna Uyundur. / Compatible with TGTC Insert. / Kompatibel mit TGTC Wendeplatten.



Delme Derinliği
Drilling Depth
Bohrtiefe

= 4x Çap
= 4x Diameter
= 4x Durchmesser

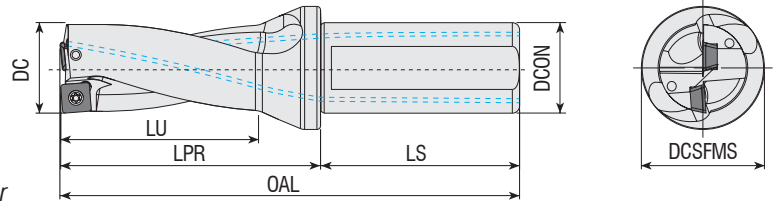

Takım Kodu
Ordering Code
Bestell-Bezeichnung

Stok
Stock
Lager

Takım Ölçüleri (mm)
Dimension (mm)
Abmessung (mm)

Maks. Ofset (radyal)
Max. Offset (radial)
Max. Versatz (radial)

Kesici Uç
Insert
Wendeschneidplatte

Yedek Parçaları / Spare Parts / Ersatzteile

Sıkma Vidası
Screw
Schraube

Tork Anahtar
Torx Key
Torx-Schlüssel

DC DCON DCSFMS OAL LU LPR LS

X_{max} DC_{max}



Takım Kodu Ordering Code Bestell-Bezeichnung	Stok Stock Lager	DC	DCON	DCSFMS	OAL	LU	LPR	LS	X _{max} DC _{max}	Kesici Uç Insert Wendeschneidplatte	Sıkma Vidası Screw Schraube	Tork Anahtar Torx Key Torx-Schlüssel
ATUM 13XD4 SP. 050204	●	13	20	25	124	52	74	50	0.75 14.5	SP. 050204	3006-M2x4	82-T06
ATUM 14XD4 SP. 050204	●	14	20	25	128	56	78	50	0.6 15.2			
ATUM 14.5XD4 SP. 050204	●	14.5	20	25	128	56	78	50	0.60 15.7			
ATUM 15XD4 SP. 050204	●	15	20	25	132	60	82	50	0.5 16			
new ATUM 15.5XD4 SP. 060204	●	15.5	20	25	132	60	82	80	0.9 17.3	SP. 060204	3007-M2.2x4.6	82-T07
ATUM 16XD4 SP. 060204	●	16	25	34	142	64	86	56	0.8 17.6			
new ATUM 16.5XD4 SP. 060204	●	16.5	25	34	142	64	86	56	0.8 18.1			
ATUM 17XD4 SP. 060204	●	17	25	34	146	68	90	56	0.75 18.5			
ATUM 17.5XD4 SP. 060204	●	17.5	25	34	146	68	90	56	0.75 19			
ATUM 18XD4 SP. 060204	●	18	25	34	150	72	94	56	0.5 19			
ATUM 19XD4 SP. 060204	●	19	25	34	154	76	98	56	0.3 19.6			
ATUM 19.5XD4 SP. 060204	●	19.5	25	34	154	76	98	56	0.3 20.1			
ATUM 20XD4 SP. 060204	●	20	25	34	158	80	102	56	0 20			
new ATUM 20.5XD4 SP. 060204	●	20.5	25	34	158	80	102	56	0 20.5			
ATUM 21XD4 SP. 060204	●	21	25	34	162	84	106	56	0 21			
new ATUM 21.5XD4 SP. 060204	●	21.5	25	34	162	84	106	56	0 21.5			
ATUM 22XD4 SP. 07T308	●	22	25	34	166	88	110	56	1 24	SP. 07T308	3008-M2.5x6	82-T08
new ATUM 22.5XD4 SP. 07T308	●	22.5	25	34	166	88	110	56	1 24.5			
ATUM 23XD4 SP. 07T308	●	23	25	34	170	92	114	56	0.75 24.5			
ATUM 23.5XD4 SP. 07T308	●	23.5	25	34	170	92	114	56	0.75 25			
ATUM 24XD4 SP. 07T308	●	24	25	34	174	96	118	56	0.5 25			
new ATUM 24.5XD4 SP. 07T308	●	24.5	25	34	174	96	118	56	0.5 25.5			
ATUM 25XD4 SP. 07T308	●	25	25	34	178	100	122	56	0.25 25.5			
new ATUM 25.5XD4 SP. 07T308	●	25.5	25	34	178	100	122	56	0.25 26			
ATUM 26XD4 SP. 07T308	●	26	25	34	182	104	126	56	0 26			
new ATUM 26.5XD4 SP. 07T308	●	26.5	25	34	208	130	152	56	0 26.5			
ATUM 27XD4 SP. 07T308	●	27	25	34	186	108	130	56	0 27			
ATUM 27.5XD4 SP. 07T308	●	27.5	25	34	186	108	130	56	0 27.5			
ATUM 28XD4 SP. 090408	●	28	25	34	190	112	134	56	1 30	SP. 090408	4015-M3.5x9	80-T15
ATUM 29XD4 SP. 090408	●	29	25	34	194	116	138	56	0.75 30.5			
ATUM 30XD4 SP. 090408	●	30	32	44	207	120	147	60	0.5 31			
ATUM 31XD4 SP. 090408	●	31	32	44	211	124	151	60	0.25 31.5			
ATUM 32XD4 SP. 090408	●	32	32	44	215	128	155	60	0 32			
ATUM 33XD4 SP. 090408	●	33	32	44	219	132	159	60	0 33			
ATUM 33.5XD4 SP. 090408	●	33.5	32	44	219	132	159	60	0 33.5			
ATUM 34XD4 SP. 110408	●	34	32	44	223	136	163	60	1 36	SP. 110408	4015-M4x11	80-T15
ATUM 35XD4 SP. 110408	●	35	32	44	227	140	167	60	0.75 36.5			
ATUM 36XD4 SP. 110408	●	36	32	44	231	144	171	60	0.6 37.2			
ATUM 37XD4 SP. 110408	●	37	32	44	235	148	175	60	0.5 38			
ATUM 38XD4 SP. 110408	●	38	32	44	239	152	179	60	0.25 38.5			
ATUM 39XD4 SP. 110408	●	39	32	44	243	156	183	60	0 39			
ATUM 40XD4 SP. 110408	●	40	32	44	247	160	187	60	0 40			
ATUM 41XD4 SP. 110408	●	41	32	44	251	164	191	60	0 41			
ATUM 42XD4 SP. 140512	●	42	32	44	255	168	195	60	1.2 44.4	SP. 140512	1020-M5x11	80-T20
ATUM 43XD4 SP. 140512	●	43	32	44	259	172	199	60	1 45			
ATUM 44XD4 SP. 140512	●	44	32	44	263	176	203	60	0.8 45.6			
new ATUM 45XD4 SP. 140512	●	45	40	54	282	180	212	70	0.6 46.2			
ATUM 46XD4 SP. 140512	●	46	40	54	286	184	216	70	0.40 46.8			

R: Sağ / Right / Rechts/ L: Sol / Left / Links

● Stokta / In Stock / Auf Lager ○ Stokta Yok / Non Stock Item / Kein Lagerartikel, Lieferzeit auf Anfrage

TGTC Ucuna Uyundur. / Compatible with TGTC Insert. / Kompatibel mit TGTC Wendeplatten.

Sipariş Örneği/Ordering Example/Bestellbeispiel

1 ad./pcs./stück ATUM 13XD4 SP. 050204

Takma Uçlu Matkap Kullanım Kılavuzu : S 427 / User's Guide For U-Drills : P 427

Bedienungsanleitung für Vollbohrer : S 427

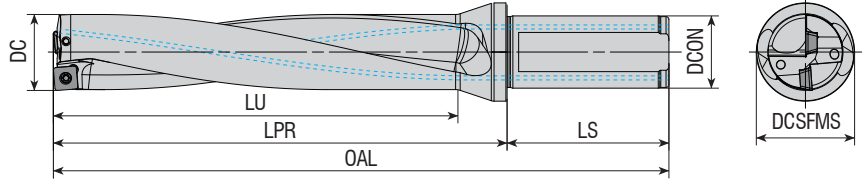

Delme Derinliği
Drilling Depth
Bohrtiefe

= 5x Çap
= 5x Diameter
= 5x Durchmesser

Takım Kodu
Ordering Code
Bestell-Bezeichnung

Stok
Stock
Lager

Takım Ölçüleri (mm)
Dimension (mm)
Abmessung (mm)

Maks. Ofset (radyal)
Max. Offset (radial)
Max. Versatz (radial)

Kesici Uç
Insert
Wendeschneidplatte

Yedek Parçaları / Spare Parts / Ersatzteile

Sıkma Vidası
Screw
Schraube

Tork Anahtar
Torx Key
Torx-Schlüssel

DC DCON DCSFMS OAL LU LPR LS

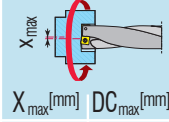

SP. 050204

SP. 060204

SP. 07T308

SP. 090408

3006-M2.5x4

3006-M2x4

3006-M2.5x4

3007-M2.2x4.6

3007-M2.2x5

82-T07

3008-M2.5x6

82-T08

4015-M3.5x9

80-T15

R: Sağ / Right / Rechts / L: Sol / Left / Links

● Stokta / In Stock / Auf Lager ○ Stokta Yok / Non Stock Item / Kein Lagerartikel, Lieferzeit auf Anfrage

TGTC Ucuna Uygundur. / Compatible with TGTC Insert. / Kompatibel mit TGTC Wendeplatten.

Sipariş Örneği/Ordering Example/Bestellbeispiel

1 ad./pcs./stück ATUM 13XD5 SP. 050204

Takma Uçlu Matkap Kullanım Kılavuzu : S 427 / User's Guide For U-Drills : P 427

Bedienungsanleitung für Vollbohrer : S 427



Delme Derinliği
Drilling Depth
Bohrtiefe

= 2x Çap
= 2x Diameter
= 2x Durchmesser

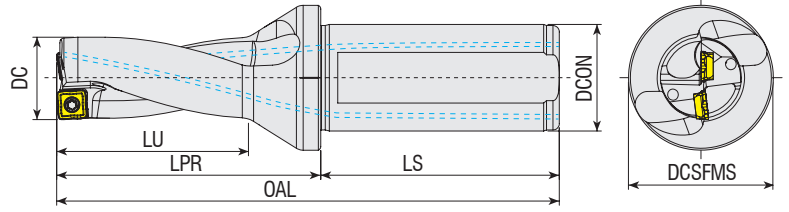

Takım Kodu
Ordering Code
Bestell-Bezeichnung

Stok Stock Lager	Takım Ölçüleri (mm) Dimension (mm) Abmessung (mm)								Maks. Offset (radyal) Max. Offset (radial) Max. Versatz (radial)		Kesici Uç Insert Wendeschneidplatte	Yedek Parçaları / Spare Parts / Ersatzteile	
	DC	DCON	DCSFMS	OAL	LU	LPR	LS	X_{max}	DC_{max}	Sıkma Vidası Screw Schraube		Tork Anahtar Torx Key Torx-Schlüssel	
ATUM 14XD2 SOMT 050204	14	20	25	100	28	50	50	0.5	15	SOMT 050204	3006-M2x4	82-T06	
ATUM 16XD2 SOMT 050204	16	25	34	110	32	54	56	0.3	16.6				
ATUM 17XD2 SOMT 060204	17	25	34	112	34	56	56	0.5	18	SOMT 060204	3007-M2.2x4.6	82-T07	
ATUM 18XD2 SOMT 060204	18	25	34	114	36	58	56	0.4	18.8				
ATUM 20XD2 SOMT 070306	20	25	34	118	40	62	56	0.5	21	SOMT 070306			
ATUM 22XD2 SOMT 070306	22	25	34	122	44	66	56	0.3	22.6				
ATUM 23XD2 SOMT 08T306	23	25	34	124	46	68	56	0.5	24	SOMT 08T306	3008-M2.5x6	82-T08	
ATUM 24XD2 SOMT 08T306	24	25	34	126	48	70	56	0.5	25				
ATUM 25XD2 SOMT 08T306	25	25	34	128	50	72	56	0.4	25.8	SOMT 08T306			
ATUM 26XD2 SOMT 08T306	26	25	34	130	52	74	56	0.3	26.6				
ATUM 27XD2 SOMT 09T308	27	25	34	132	54	76	56	0.5	28	SOMT 09T308			
ATUM 28XD2 SOMT 09T308	28	25	34	134	56	78	56	0.5	29				
ATUM 29XD2 SOMT 09T308	29	25	34	136	58	80	56	0.5	30	SOMT 09T308	4015-M3.5x9	80-T15	
ATUM 30XD2 SOMT 09T308	30	32	44	147	60	87	60	0.5	31				
ATUM 32XD2 SOMT 11T308	32	32	44	151	64	91	60	0.5	33	SOMT 11T308			
ATUM 33XD2 SOMT 11T308	33	32	44	153	66	93	60	0.5	34				
ATUM 34XD2 SOMT 11T308	34	32	44	155	68	95	60	0.5	35	SOMT 11T308			
ATUM 35XD2 SOMT 11T308	35	32	44	157	70	97	60	0.5	36				
ATUM 37XD2 SOMT 130408	37	32	44	161	74	101	60	0.5	38	SOMT 130408	4015-M4x11		
ATUM 38XD2 SOMT 130408	38	32	44	163	76	103	60	0.5	39				
ATUM 40XD2 SOMT 130408	40	32	44	167	80	107	60	0.5	41	SOMT 130408			
ATUM 45XD2 SOMT 150510	45	40	54	192	90	122	70	0.5	46				
ATUM 47XD2 SOMT 150510	47	40	54	196	94	126	70	0.5	48	SOMT 150510	1020-M5x11	80-T20	

R: Sağ / Right / Rechts/ L: Sol / Left / Links

● Stokta / In Stock / Auf Lager ○ Stokta Yok / Non Stock Item / Kein Lagerartikel, Lieferzeit auf Anfrage

TGTC Ucuna Uygundur. / Compatible with TGTC Insert. / Kompatibel mit TGTC Wendeplatten.

Sipariş Örneği/Ordering Example/Bestellbeispiel

1 ad./pcs./stück ATUM 14XD2 SOMT 050204

Takma Uçlu Matkap Kullanım Kılavuzu : S 427 / User's Guide For U-Drills : P 427

Bedienungsanleitung für Vollbohrer : S 427



Delme Derinliği = 3x Çap
Drilling Depth = 3x Diameter
Bohrtiefe = 3x Durchmesser

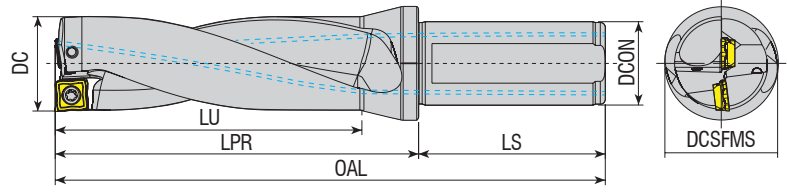

Takım Kodu
Ordering Code
Bestell-Bezeichnung

Stok Stock Lager	Takım Ölçüleri (mm) Dimension (mm) Abmessung (mm)								Maks. Ofset (radyal) Max. Offset (radial) Max. Versatz (radial)		Kesici Uç Insert Wendeschneidplatte	Yedek Parçaları / Spare Parts / Ersatzteile		
	DC	DCON	DCSFMS	OAL	LU	LPR	LS	X _{max}	X _{max} [mm]	DC _{max} [mm]		Sıkma Vidası Screw Schraube	Tork Anahtar Torx Key Torx-Schlüssel	
●	14	20	25	114	42	64	50	0.5	15	SOMT 050204	3006-M2x4	82-T06		
●	14.5	20	25	114	42	64	50	0.4	15.3					
●	15	20	25	117	45	67	50	0.4	15.8					
●	15.5	20	25	117	45	67	50	0.3	16.1					
●	16	25	34	126	48	70	56	0.3	16.6	SOMT 060204	3007-M2.2x4.6	82-T07		
●	16.5	25	34	126	48	70	56	0.5	17.5					
●	17	25	34	129	51	73	56	0.5	18					
●	17.5	25	34	129	51	73	56	0.4	18.3					
●	18	25	34	132	54	76	56	0.4	18.8	SOMT 070306	3008-M2.5x6	82-T08		
●	18.5	25	34	132	54	76	56	0.3	19.1					
●	19	25	34	135	57	79	56	0.3	19.6					
●	19.5	25	34	135	57	79	56	0.5	20.5					
●	20	25	34	138	60	82	56	0.5	21	SOMT 08T306	4015-M3.5x9	80-T15		
●	20.5	25	34	138	60	82	56	0.4	21.3					
●	21	25	34	141	63	85	56	0.4	21.8					
●	22	25	34	144	66	88	56	0.3	22.6					
●	22.5	25	34	144	66	88	56	0.5	23.5	SOMT 09T308	4015-M4x11	80-T20		
●	23	25	34	147	69	91	56	0.5	24					
●	23.5	25	34	147	69	91	56	0.5	24.5					
●	24	25	34	150	72	94	56	0.5	25					
●	24.5	25	34	150	72	94	56	0.4	25.3	SOMT 11T308	1020-M5x11	80-T20		
●	25	25	34	153	75	97	56	0.4	25.8					
●	26	25	34	156	78	100	56	0.3	26.6					
●	27	25	34	159	81	103	56	0.5	28					
●	27.5	25	34	159	81	103	56	0.5	27.5	SOMT 130408	1020-M5x11	80-T20		
●	28	25	34	162	84	106	56	0.5	29					
●	29	25	34	165	87	109	56	0.5	30					
●	30	32	44	177	90	117	60	0.5	31					
●	32	32	44	183	96	123	60	0.5	33	SOMT 150510	1020-M5x11	80-T20		
●	33	32	44	186	99	126	60	0.5	34					
●	34	32	44	189	102	129	60	0.5	35					
●	35	32	44	192	105	132	60	0.5	36					
●	36	32	44	195	108	135	60	0.4	36.8	SOMT 150510	1020-M5x11	80-T20		
●	37	32	44	198	111	138	60	0.5	38					
●	38	32	44	201	114	141	60	0.5	39					
●	39	32	44	204	117	144	60	0.5	40					
●	40	32	44	207	120	147	60	0.5	41	SOMT 150510	1020-M5x11	80-T20		
●	45	40	54	237	135	167	70	0.5	46					
●	49	40	54	249	147	179	70	0.5	50					
●	50	40	54	252	150	182	70	0.5	51					

R: Sağ / Right / Rechts/ L: Sol / Left / Links
● Stokta / In Stock / Auf Lager ○ Stokta Yok / Non Stock Item / Kein Lagerartikel, Lieferzeit auf Anfrage

TGTC Ucuna Uygundur. / Compatible with TGTC Insert. / Kompatibel mit TGTC Wendeplatten.

Sipariş Örneği/Ordering Example/Bestellbeispiel
1 ad./pcs./stück ATUM 14XD3 SOMT 050204

Takma Uçlu Matkap Kullanım Kılavuzu : S 427 / User's Guide For U-Drills : P 427
Bedienungsanleitung für Vollbohrer : S 427



Delme Derinliği
Drilling Depth
Bohrtiefe
= 4x Çap
= 4x Diameter
= 4x Durchmesser

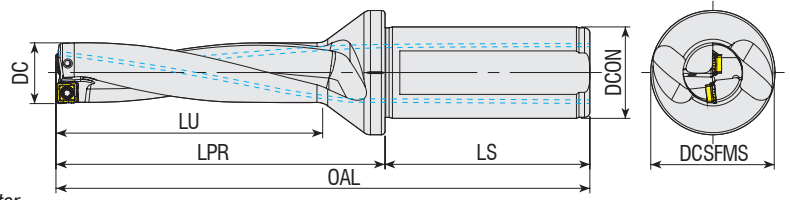

Takım Kodu Ordering Code Bestell-Bezeichnung	Stok Stock Lager	Takım Ölçüleri (mm) Dimension (mm) Abmessung (mm)							Maks. Ofset (radyal) Max. Offset (radial) Max. Versatz (radial)		Kesici Uç Insert Wendeschneidplatte	Yedek Parçaları / Spare Parts / Ersatzteile	
		DC	DCON	DCSFMS	OAL	LU	LPR	LS	X _{max}	DC _{max}		Sıkma Vidası Screw Schraube	Tork Anahtar Torx Key Torx-Schlüssel
ATUM 14XD4 SOMT 050204	●	14	20	25	128	56	78	50	0.5	15	SOMT 050204	3006-M2x4	82-T06
ATUM 14.5XD4 SOMT 050204	●	14.5	20	25	128	56	78	50	0.4	15.3			
ATUM 16XD4 SOMT 050204	●	16	25	34	142	64	86	56	0.3	16.6			
ATUM 17XD4 SOMT 060204	●	17	25	34	146	68	90	56	0.5	18	SOMT 060204	3007-M2.2x4.6	82-T07
ATUM 17.5XD4 SOMT 060204	●	17.5	25	34	146	68	90	56	0.4	18.3			
ATUM 18XD4 SOMT 060204	●	18	25	34	150	72	94	56	0.4	18.8			
ATUM 19XD4 SOMT 060204	●	19	25	34	154	76	98	56	0.3	19.6	SOMT 070306		
ATUM 20XD4 SOMT 070306	●	20	25	34	158	80	102	56	0.5	21			
ATUM 21XD4 SOMT 070306	●	21	25	34	162	84	106	56	0.4	21.8			
ATUM 22XD4 SOMT 070306	●	22	25	34	166	88	110	56	0.3	22.6	SOMT 08T306	3008-M2.5x6	82-T08
ATUM 24XD4 SOMT 08T306	●	24	25	34	174	96	118	56	0.5	25			
ATUM 25XD4 SOMT 08T306	●	25	25	34	178	100	122	56	0.4	25.8			

R: Sağ / Right / Rechts/ L: Sol / Left / Links

● Stokta / In Stock / Auf Lager ○ Stokta Yok / Non Stock Item / Kein Lagerartikel, Lieferzeit auf Anfrage

TGTC Ucuna Uyundur. / Compatible with TGTC Insert. / Kompatibel mit TGTC Wendeplatten.

Sipariş Örneği/Ordering Example/Bestellbeispiel

1 ad./pcs./stück ATUM 14XD4 SOMT 050204

Takma Uçlu Matkap Kullanım Kılavuzu : S 427 / User's Guide For U-Drills : P 427

Bedienungsanleitung für Vollbohrer : S 427





Delme Derinliği
Drilling Depth
Bohrtiefe

= 5x Çap
= 5x Diameter
= 5x Durchmesser

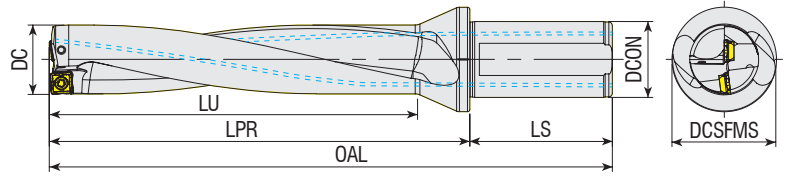

Takım Kodu
Ordering Code
Bestell-Bezeichnung

Stok
Stock
Lager

Takım Ölçüleri (mm)
Dimension (mm)
Abmessung (mm)

Maks. Ofset (radyal)
Max. Offset (radial)
Max. Versatz (radial)

Kesici Uç
Insert
Wendeschneidplatte

Yedek Parçaları / Spare Parts / Ersatzteile

Sıkma Vidası
Screw
Schraube

Tork Anahtar
Torx Key
Torx-Schlüssel

Takım Kodu Ordering Code Bestell-Bezeichnung	Stok Stock Lager	Takım Ölçüleri (mm) Dimension (mm) Abmessung (mm)							Maks. Ofset (radyal) Max. Offset (radial) Max. Versatz (radial)		Kesici Uç Insert Wendeschneidplatte	Sıkma Vidası Screw Schraube	Tork Anahtar Torx Key Torx-Schlüssel
		DC	DCON	DCSFMS	OAL	LU	LPR	LS	X _{max}	DC _{max} [mm]			
ATUM 14XD5 SOMT 050204	●	14	20	25	142	70	92	50	0.5	15	SOMT 050204	3006-M2x4	82-T06
ATUM 15XD5 SOMT 050204	●	15	20	25	147	75	97	50	0.4	15.8			
ATUM 15.5XD5 SOMT 050204	●	15.5	20	25	147	75	97	50	0.3	16.1			
ATUM 16XD5 SOMT 050204	●	16	25	34	158	80	102	56	0.3	16.6			
ATUM 16.5XD5 SOMT 060204	●	16.5	25	34	158	80	102	56	0.5	17.5	SOMT 060204	3007-M2.2x4.6	82-T07
ATUM 17.5XD5 SOMT 060204	●	17.5	25	34	163	85	107	56	0.4	18.3			
ATUM 18XD5 SOMT 060204	●	18	25	34	168	90	112	56	0.4	18.8			
ATUM 18.5XD5 SOMT 060204	●	18.5	25	34	168	90	112	56	0.3	19.1			
ATUM 19XD5 SOMT 060204	●	19	25	34	173	95	117	56	0.3	19.6	SOMT 070306	3007-M2.2x4.6	82-T07
ATUM 19.5XD5 SOMT 070306	●	19.5	25	34	173	95	117	56	0.5	20.5			
ATUM 20XD5 SOMT 070306	●	20	25	34	178	100	122	56	0.5	21			
ATUM 21XD5 SOMT 070306	●	21	25	34	183	105	127	56	0.4	21.8			
ATUM 22XD5 SOMT 070306	●	22	25	34	188	110	132	56	0.3	22.6	SOMT 08T306	3008-M2.5x6	82-T08
ATUM 23XD5 SOMT 08T306	●	23	25	34	193	115	137	56	0.5	24			
ATUM 24XD5 SOMT 08T306	●	24	25	34	198	120	142	56	0.5	25			
ATUM 25XD5 SOMT 08T306	●	25	25	34	203	125	147	56	0.4	25.8			
ATUM 26XD5 SOMT 08T306	●	26	25	34	208	130	152	56	0.3	26.6	SOMT 09T308	4015-M3.5x9	80-T15
ATUM 27XD5 SOMT 09T308	●	27	25	34	213	135	157	56	0.5	28			
ATUM 28XD5 SOMT 09T308	●	28	25	34	218	140	162	56	0.5	29			
ATUM 29XD5 SOMT 09T308	●	29	25	34	223	145	167	56	0.5	30			
ATUM 30XD5 SOMT 09T308	●	30	32	44	237	150	177	60	0.5	31	SOMT 11T308	4015-M3.5x9	80-T15
ATUM 33XD5 SOMT 11T308	●	33	32	44	252	165	192	60	0.5	34			
ATUM 34XD5 SOMT 11T308	●	34	32	44	257	170	197	60	0.5	35			
ATUM 35XD5 SOMT 11T308	●	35	32	44	262	175	202	60	0.5	36			
ATUM 36XD5 SOMT 11T308	●	36	32	44	267	180	207	60	0.4	36.8			

R: Sağ / Right / Rechts / L: Sol / Left / Links

● Stokta / In Stock / Auf Lager ○ Stokta Yok / Non Stock Item / Kein Lagerartikel, Lieferzeit auf Anfrage

TGTC Ucuna Uygundur. / Compatible with TGTC Insert. / Kompatibel mit TGTC Wendeplatten.

Sipariş Örneği/Ordering Example/Bestellbeispiel

1 ad./pcs./stück ATUM 14XD5 SOMT 050204

Takma Uçlu Matkap Kullanım Kılavuzu : S 427 / User's Guide For U-Drills : P 427

Bedienungsanleitung für Vollbohrer : S 427



Delme Derinliği
Drilling Depth
Bohrtiefe

= 2x Çap
= 2x Diameter
= 2x Durchmesser

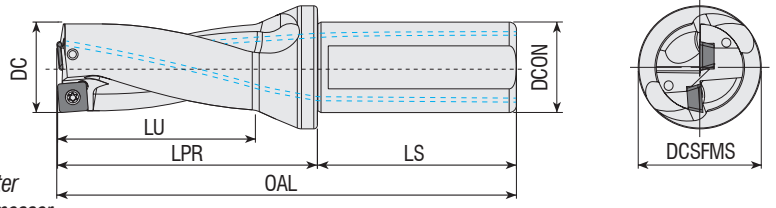

Takım Kodu
Ordering Code
Bestell-Bezeichnung

Stok
Stock
Lager

Takım Ölçüleri (mm)
Dimension (mm)
Abmessung (mm)

Maks. Ofset (radyal)
Max. Offset (radial)
Max. Versatz (radial)

Kesici Uç
Insert
Wendeschneidplatte

Yedek Parçaları / Spare Parts / Ersatzteile

Sıkma Vidası
Screw
Schraube

Tork Anahtar
Torx Key
Torx-Schlüssel

Takım Kodu Ordering Code Bestell-Bezeichnung	Stok Stock Lager	Takım Ölçüleri (mm) Dimension (mm) Abmessung (mm)							Maks. Ofset (radyal) Max. Offset (radial) Max. Versatz (radial)		Kesici Uç Insert Wendeschneidplatte	Sıkma Vidası Screw Schraube	Tork Anahtar Torx Key Torx-Schlüssel			
		DC	DCON	DCSFMS	OAL	LU	LPR	LS	X _{max}	DC _{max}						
ATUM 12.5XD2 SPGT 050204	●	12.5	20	25	96	24	46	50	0.75	14	SPGT 050204	3006-M2x4	82-T06			
ATUM 13XD2 SPGT 050204	●	13	20	25	98	26	48	50	0.75	14.5						
ATUM 13.5XD2 SPGT 050204	●	13.5	20	25	98	26	48	50	0.75	15						
ATUM 14XD2 SPGT 050204	●	14	20	25	100	28	50	50	0.6	15.2						
ATUM 15XD2 SPGT 050204	●	15	20	25	102	30	52	50	0.5	16						
ATUM 16XD2 SPGT 060204	●	16	25	34	110	32	54	56	0.8	17.6	SPGT 060204	3007-M2.2x4.6	82-T07			
ATUM 16.5XD2 SPGT 060204	●	16.5	25	34	110	32	54	56	0.8	18.1						
ATUM 17XD2 SPGT 060204	●	17	25	34	112	34	56	56	0.75	18.5						
ATUM 17.5XD2 SPGT 060204	●	17.5	25	34	112	34	56	56	0.75	19						
ATUM 18XD2 SPGT 060204	●	18	25	34	114	36	58	56	0.5	19						
ATUM 19XD2 SPGT 060204	●	19	25	34	116	38	60	56	0.3	19.6						
ATUM 20XD2 SPGT 060204	●	20	25	34	118	40	62	56	0	20						
ATUM 21XD2 SPGT 060204	●	21	25	34	120	42	64	56	0	21						
ATUM 22XD2 SPGT 07T308	●	22	25	34	122	44	66	56	1	24				SPGT 07T308	3008-M2.5x6	82-T08
ATUM 22.5XD2 SPGT 07T308	●	22.5	25	34	122	44	66	56	1	24.5						
ATUM 23XD2 SPGT 07T308	●	23	25	34	124	46	68	56	0.75	24.5						
ATUM 23.5XD2 SPGT 07T308	●	23.5	25	34	124	46	68	56	0.75	25						
ATUM 24XD2 SPGT 07T308	●	24	25	34	126	48	70	56	0.5	25						
ATUM 24.5XD2 SPGT 07T308	●	24.5	25	34	126	48	70	56	0.5	25.5						
ATUM 25XD2 SPGT 07T308	●	25	25	34	128	50	72	56	0.25	25.5						
ATUM 26XD2 SPGT 07T308	●	26	25	34	130	52	74	56	0	26	SPGT 090408	4015-M3.5x9	80-T15			
ATUM 28XD2 SPGT 090408	●	28	25	34	134	56	78	56	1	30						
ATUM 29XD2 SPGT 090408	●	29	25	34	136	58	80	56	0.75	30.5						
ATUM 30XD2 SPGT 090408	●	30	32	44	147	60	87	60	0.5	31						
ATUM 31XD2 SPGT 090408	●	31	32	44	149	62	89	60	0.25	31.5						
ATUM 32XD2 SPGT 090408	●	32	32	44	151	64	91	60	0	32	SPGT 110408	4015-M4x11	80-T15			
ATUM 35XD2 SPGT 110408	●	35	32	44	157	70	97	60	0.75	36.5						
ATUM 36XD2 SPGT 110408	●	36	32	44	159	72	99	60	0.6	37.2						
ATUM 40XD2 SPGT 110408	●	40	32	44	167	80	107	60	0	40						

R: Sağ / Right / Rechts/ L: Sol / Left / Links

● Stokta / In Stock / Auf Lager ○ Stokta Yok / Non Stock Item / Kein Lagerartikel, Lieferzeit auf Anfrage

ZCC Ucuna Uygundur. / Compatible with ZCC Insert. / Kompatibel mit ZCC Wendeplatten.

Sipariş Örneği/Ordering Example/Bestellbeispiel

1 ad./pcs./stück ATUM 12.5XD2 SPGT 050204

Takma Uçlu Matkap Kullanım Kılavuzu : S 427 / User's Guide For U-Drills : P 427

Bedienungsanleitung für Vollbohrer : S 427





Delme Derinliği
Drilling Depth
Bohrtiefe

= 3x Çap
= 3x Diameter
= 3x Durchmesser

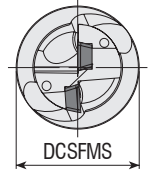
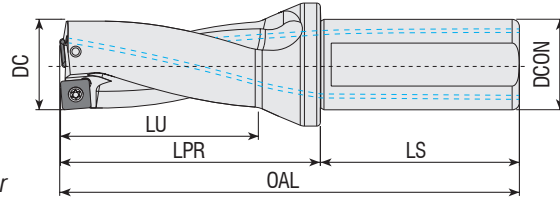

Takım Kodu Ordering Code Bestell-Bezeichnung	Stok Stock Lager	Takım Ölçüleri (mm) Dimension (mm) Abmessung (mm)							Maks. Offset (radial) Max. Offset (radial) Max. Versatz (radial)		Kesici Uç Insert Wendeschneidplatte	Yedek Parçaları / Spare Parts / Ersatzteile	
		DC	DCON	DCSFMS	OAL	LU	LPR	LS	X _{max}	DC _{max}		Sıkma Vidası Screw Schraube	Tork Anahtar Torx Key Torx-Schlüssel
ATUM 12.5XD3 SPGT 050204	●	12.5	20	25	108	36	58	50	0.75	14	SPGT 050204	3006-M2x4	82-T06
ATUM 13XD3 SPGT 050204	●	13	20	25	111	39	61	50	0.75	14.5			
ATUM 13.5XD3 SPGT 050204	●	13.5	20	25	111	39	61	50	0.75	15			
ATUM 14XD3 SPGT 050204	●	14	20	25	114	42	64	50	0.6	15.2			
ATUM 14.5XD3 SPGT 050204	●	14.5	20	25	114	42	64	50	0.6	15.7			
ATUM 15XD3 SPGT 050204	●	15	20	25	117	45	67	50	0.5	16			
ATUM 15.5XD3 SPGT 060204	●	15.5	20	25	117	45	67	50	0.9	17.3	SPGT 060204	3007-M2.2x4.6	82-T07
ATUM 16XD3 SPGT 060204	●	16	25	34	126	48	70	56	0.8	17.6			
ATUM 16.5XD3 SPGT 060204	●	16.5	25	34	126	48	70	56	0.8	18.1			
ATUM 17XD3 SPGT 060204	●	17	25	34	129	51	73	56	0.75	18.5			
ATUM 17.5XD3 SPGT 060204	●	17.5	25	34	129	51	73	56	0.75	19			
ATUM 18XD3 SPGT 060204	●	18	25	34	132	54	76	56	0.5	19			
ATUM 18.5XD3 SPGT 060204	●	18.5	25	34	132	54	76	56	0.5	19.5			
ATUM 19XD3 SPGT 060204	●	19	25	34	135	57	79	56	0.3	19.6			
ATUM 19.5XD3 SPGT 060204	●	19.5	25	34	135	57	79	56	0.3	20.1			
ATUM 20XD3 SPGT 060204	●	20	25	34	138	60	82	56	0	20			
ATUM 20.5XD3 SPGT 060204	●	20.5	25	34	138	60	82	56	0	20.5			
ATUM 21XD3 SPGT 060204	●	21	25	34	141	63	85	56	0	21			
ATUM 21.5XD3 SPGT 060204	●	21.5	25	34	141	63	85	56	0	21.5			
ATUM 22XD3 SPGT 07T308	●	22	25	34	144	66	88	56	1	24	SPGT 07T308	3008-M2.5x6	82-T08
ATUM 22.5XD3 SPGT 07T308	●	22.5	25	34	144	66	88	56	1	24.5			
ATUM 23XD3 SPGT 07T308	●	23	25	34	147	69	91	56	0.75	24.5			
ATUM 23.5XD3 SPGT 07T308	●	23.5	25	34	147	69	91	56	0.75	25			
ATUM 24XD3 SPGT 07T308	●	24	25	34	150	72	94	56	0.5	25			
ATUM 24.5XD3 SPGT 07T308	●	24.5	25	34	150	72	94	56	0.5	25.5			
ATUM 25XD3 SPGT 07T308	●	25	25	34	153	75	97	56	0.25	25.5			
ATUM 25.5XD3 SPGT 07T308	●	25.5	25	34	153	75	97	56	0.25	26			
ATUM 26XD3 SPGT 07T308	●	26	25	34	156	78	100	56	0	26			
ATUM 26.5XD3 SPGT 07T308	●	26.5	25	34	156	78	100	56	0	26.5			
ATUM 27XD3 SPGT 07T308	●	27	25	34	159	81	103	56	0	27			
ATUM 27.5XD3 SPGT 07T308	●	27.5	25	34	159	81	103	56	0	27.5			
ATUM 28XD3 SPGT 090408	●	28	25	34	162	84	106	56	1	30	SPGT 090408	4015-M3.5x9	80-T15
ATUM 28.5XD3 SPGT 090408	●	28.5	25	34	162	84	106	56	1	30.5			
ATUM 29XD3 SPGT 090408	●	29	25	34	165	87	109	56	0.75	30.5			
ATUM 29.5XD3 SPGT 090408	●	29.5	25	34	165	87	109	56	0.75	31			
ATUM 30XD3 SPGT 090408	●	30	32	44	177	90	117	60	0.5	31			
ATUM 31XD3 SPGT 090408	●	31	32	44	180	93	120	60	0.25	31.5			
ATUM 32XD3 SPGT 090408	●	32	32	44	183	96	123	60	0	32			
ATUM 33XD3 SPGT 090408	●	33	32	44	186	99	126	60	0	33			

R: Sağ / Right / Rechts/ L: Sol / Left / Links

● Stokta / In Stock / Auf Lager ○ Stokta Yok / Non Stock Item / Kein Lagerartikel, Lieferzeit auf Anfrage

ZCC Ucuna Uygundur. / Compatible with ZCC Insert. / Kompatibel mit ZCC Wendeplatten.

Sipariş Örneği/Ordering Example/Bestellbeispiel

1 ad./pcs./stück ATUM 12.5XD3 SPGT 050204

Takma Uçlu Matkap Kullanım Kılavuzu : S 427 / User's Guide For U-Drills : P 427

Bedienungsanleitung für Vollbohrer : S 427

ZCC Ucuna Uygundur. / Compatible with ZCC Insert. / Kompatibel mit ZCC Wendeplatten.



Delme Derinliği
Drilling Depth
Bohrtiefe
= 3x Çap
= 3x Diameter
= 3x Durchmesser

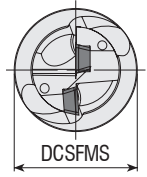
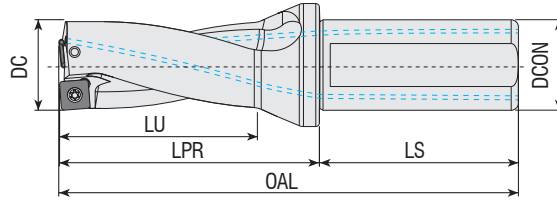

Takım Kodu Ordering Code Bestell-Bezeichnung	Stok Stock Lager	Takım Ölçüleri (mm) Dimension (mm) Abmessung (mm)							Maks. Ofset (radyal) Max. Offset (radial) Max. Versatz (radial)		Kesici Uç Insert Wendeschneidplatte	Yedek Parçaları / Spare Parts / Ersatzteile	
		DC	DCON	DCSFMS	OAL	LU	LPR	LS	X _{max}	DC _{max}		Sıkma Vidası Screw Schraube	Tork Anahtar Torx Key Torx-Schlüssel
ATUM 34XD3 SPGT 110408	●	34	32	44	189	102	129	60	1	36	SPGT 110408	4015-M4x11	80-T15
ATUM 35XD3 SPGT 110408	●	35	32	44	192	105	132	60	0.75	36.5			
ATUM 36XD3 SPGT 110408	●	36	32	44	195	108	135	60	2.5	41			
ATUM 36.5XD3 SPGT 110408	●	36.5	32	44	195	110	135	60	0.6	37.7			
ATUM 37XD3 SPGT 110408	●	37	32	44	198	111	138	60	0.5	38			
ATUM 38XD3 SPGT 110408	●	38	32	44	201	114	141	60	0.25	38.5			
ATUM 39XD3 SPGT 110408	●	39	32	44	204	117	144	60	0	39			
ATUM 40XD3 SPGT 110408	●	40	32	44	207	120	147	60	0	40			
ATUM 42XD3 SPGT 140512	●	42	32	44	213	126	153	60	1.2	44.4	SPGT 140512	1020-M5x11	80-T20
ATUM 43XD3 SPGT 140512	●	43	32	44	216	129	156	60	1	45			
ATUM 44XD3 SPGT 140512	●	44	32	44	219	132	159	60	0.8	45.6			
ATUM 49XD3 SPGT 140512	●	49	40	54	249	147	179	70	0	49			
ATUM 50XD3 SPGT 140512	●	50	40	54	252	150	182	70	0	50			

R: Sağ / Right / Rechts L: Sol / Left / Links

● Stokta / In Stock / Auf Lager ○ Stokta Yok / Non Stock Item / Kein Lagerartikel, Lieferzeit auf Anfrage

ZCC Ucuna Uygundur. / Compatible with ZCC Insert. / Kompatibel mit ZCC Wendeplatten.

Sipariş Örneği/Ordering Example/Bestellbeispiel

1 ad./pcs./stück ATUM 34XD3 SPGT 110408

Takma Uçlu Matkap Kullanım Kılavuzu : S 427 / User's Guide For U-Drills : P 427
Bedienungsanleitung für Vollbohrer : S 427





Delme Derinliği
Drilling Depth
Bohrtiefe

= 4x Çap
= 4x Diameter
= 4x Durchmesser

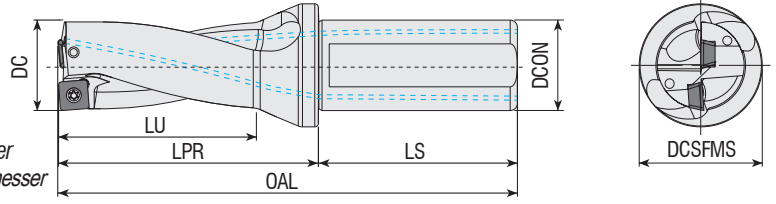

Takım Kodu Ordering Code Bestell-Bezeichnung	Stok Stock Lager	Takım Ölçüleri (mm) Dimension (mm) Abmessung (mm)							Maks. Ofset (radyal) Max. Offset (radial) Max. Versatz (radial)		Kesici Uç Insert Wendeschneidplatte	Yedek Parçaları / Spare Parts / Ersatzteile	
		DC	DCON	DCSFMS	OAL	LU	LPR	LS	X_{max}	DC_{max}		Sıkma Vidası Screw Schraube	Tork Anahtar Torx Key Torx-Schlüssel
ATUM 13XD4 SPGT 050204	●	13	20	25	124	52	74	50	0.75	14.5	SPGT 050204	3006-M2x4	82-T06
ATUM 14XD4 SPGT 050204	●	14	20	25	128	56	78	50	0.6	15.2			
ATUM 14.5XD4 SPGT 050204	●	14.5	20	25	128	58	78	50	0.6	15.7			
ATUM 15XD4 SPGT 050204	●	15	20	25	132	60	82	50	0.5	16			
ATUM 16XD4 SPGT 060204	●	16	25	34	142	64	86	56	0.8	17.6			
ATUM 17XD4 SPGT 060204	●	17	25	34	146	68	90	56	0.75	18.5	SPGT 060204	3007-M2.2x5	82-T07
ATUM 17.5XD4 SPGT 060204	●	17.5	25	34	146	68	90	56	0.75	19			
ATUM 18XD4 SPGT 060204	●	18	25	34	150	72	94	56	0.5	19			
ATUM 19XD4 SPGT 060204	●	19	25	34	154	76	98	56	0.3	19.6			
ATUM 19.5XD4 SPGT 060204	●	19.5	25	34	154	76	98	56	0.3	20.1			
ATUM 20XD4 SPGT 060204	●	20	25	34	158	80	102	56	0	20			
ATUM 21XD4 SPGT 060204	●	21	25	34	162	84	106	56	0	21			
ATUM 22XD4 SPGT 07T308	●	22	25	34	166	88	110	56	1	24	SPGT 07T308	3008-M2.5x6	82-T08
ATUM 23XD4 SPGT 07T308	●	23	25	34	170	92	114	56	0.75	24.5			
ATUM 23.5XD4 SPGT 07T308	●	23.5	25	34	170	92	114	56	0.75	25			
ATUM 24XD4 SPGT 07T308	●	24	25	34	174	96	118	56	0.5	25			
ATUM 25XD4 SPGT 07T308	●	25	25	34	178	100	122	56	0.25	25.5			
ATUM 26XD4 SPGT 07T308	●	26	25	34	182	104	126	56	0	26			
ATUM 27.5XD4 SPGT 07T308	●	27.5	25	34	186	108	130	56	0	27.5			
ATUM 28XD4 SPGT 090408	●	28	25	34	190	112	134	56	1	30	SPGT 090408	4015-M3.5x9	80-T15
ATUM 29XD4 SPGT 090408	●	29	25	34	194	116	138	56	0.75	30.5			
ATUM 30XD4 SPGT 090408	●	30	32	44	207	120	147	60	0.5	31			
ATUM 31XD4 SPGT 090408	●	31	32	44	211	124	151	60	0.75	32.5			
ATUM 32XD4 SPGT 090408	●	32	32	44	215	128	155	60	0	32			
ATUM 33.5XD4 SPGT 090408	●	33.5	32	44	219	132	159	60	0	33.5			
ATUM 38XD4 SPGT 110408	●	38	32	44	239	152	179	60	0.25	38.5			



Delme Derinliği
Drilling Depth
Bohrtiefe

= 5x Çap
= 5x Diameter
= 5x Durchmesser

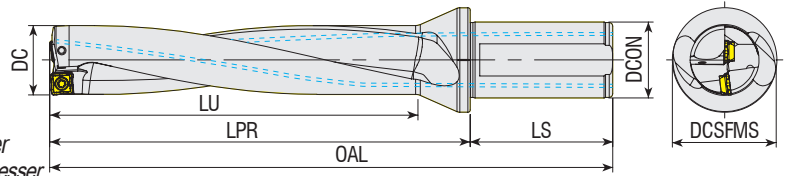

Takım Kodu Ordering Code Bestell-Bezeichnung	Stok Stock Lager	Takım Ölçüleri (mm) Dimension (mm) Abmessung (mm)							Maks. Ofset (radyal) Max. Offset (radial) Max. Versatz (radial)		Kesici Uç Insert Wendeschneidplatte	Yedek Parçaları / Spare Parts / Ersatzteile	
		DC	DCON	DCSFMS	OAL	LU	LPR	LS	X_{max}	DC_{max}		Sıkma Vidası Screw Schraube	Tork Anahtar Torx Key Torx-Schlüssel
ATUM 22XD5 SPGT 07T308	●	22	25	34	188	110	132	56	1	24	SPGT 07T308	3008-M2.5x6	82-T08
ATUM 26XD5 SPGT 07T308-32	●	26	32	44	217	130	157	60	0	26			

R: Sağ / Right / Rechts/ L: Sol / Left / Links

● Stokta / In Stock / Auf Lager ○ Stokta Yok / Non Stock Item / Kein Lagerartikel, Lieferzeit auf Anfrage

ZCC Ucuna Uygun. / Compatible with ZCC Insert. / Kompatibel mit ZCC Wendeplatten.

Takma Uçlu Matkap Kullanım Kılavuzu : S 427 / User's Guide For U-Drills : P 427

Bedienungsanleitung für Vollbohrer : S 427

Sipariş Örneği/Ordering Example/Bestellbeispiel

1 ad./pcs./stück ATUM 13XD4 SPGT 050204



*konusulan
the spoken kalite...
quality...*

EKONOMİK KESİCİLER

EKONOMİK KESİCİLER

MULTI FUNCTIONAL CUTTING TOOLS

MULTIFUNKTIONALES DREH- UND BOHRWERKZEUG





AKKO **A** **EK** **R** - **D2.25** x **20**

X **C** **.** **.** **10** **T3** **04**

2 Kesiş Stili / Cutter Style / Werkzeugtyp
EK : Ekonomik Kesici / Economic Cutting
Multifunktionales Dreh- und Bohrwerkzeug

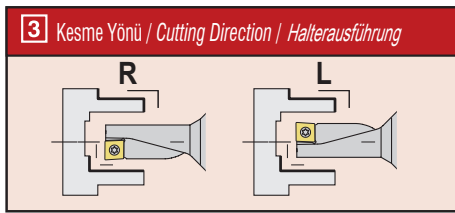

11 Kalınlık / Thickness / Dicke

01	s = 1.59
T1	s = 1.98
02	s = 2.38
T2	s = 2.78
03	s = 3.18
T3	s = 3.97
04	s = 4.76
05	s = 5.56
06	s = 6.35
07	s = 7.94
09	s = 9.52

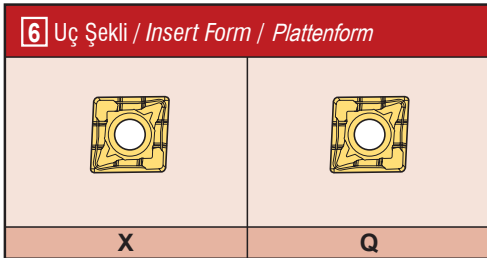
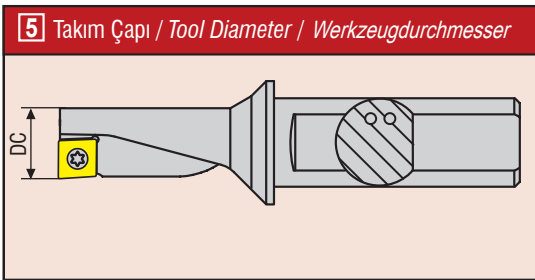
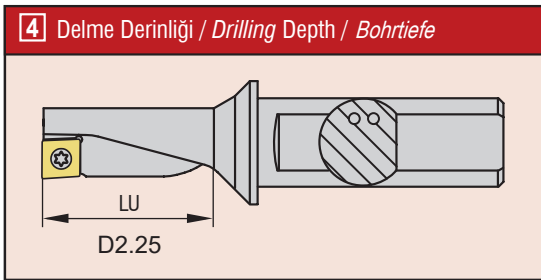

8 Toleranslar / Tolerance Classes / Toleranzen

	IC	M	S
A	± 0.025	± 0.005	± 0.025
C	± 0.025	± 0.013	± 0.025
E	± 0.025	± 0.025	± 0.025
F	± 0.013	± 0.005	± 0.025
G	± 0.025	± 0.025	± 0.130
H	± 0.013	± 0.013	± 0.025
J	± 0.05-0.15	± 0.005	± 0.025
K	± 0.05-0.15	± 0.013	± 0.025
L	± 0.05-0.15	± 0.025	± 0.025
M	± 0.05-0.15	± 0.08-0.20	± 0.130
N	± 0.05-0.15	± 0.08-0.20	± 0.025
U	± 0.08-0.25	± 0.13-0.38	± 0.130

IC : Daire Ölçüsü / Inscribed Circle
M : Şekle Göre / Refer to Figure
S : Kalınlık / Thickness

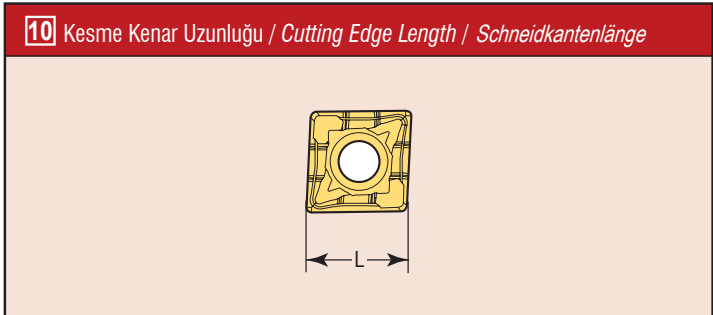
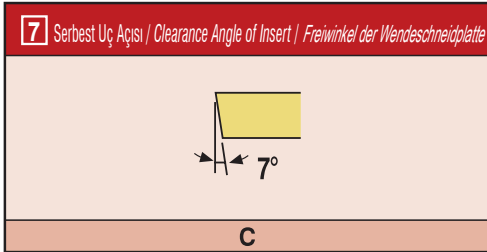
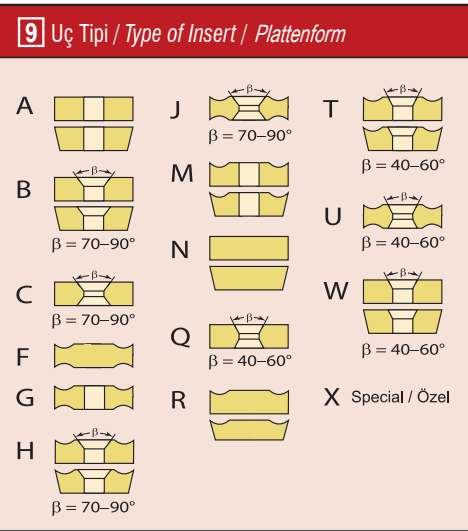



12 Köşe Konfigürasyonu / Corner Radius / Eckenradius

01	RE=0.1	12	RE=1.2
02	RE=0.2	16	RE=1.6
04	RE=0.4	24	RE=2.4
08	RE=0.8		

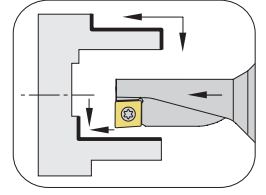
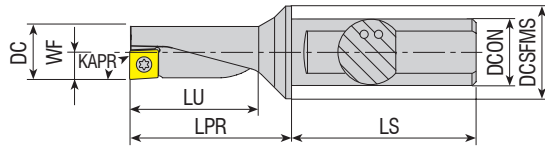
CRTZT Ucuna Uygundur. / Compatible with CRTZT Insert. / Kompatibel mit CRTZT Wendeplatten.



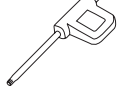

Takım Kodu Ordering Code Bestell-Bezeichnung	Stok Stock Lager		Takım Ölçüleri (mm) Dimension (mm) Abmessung (mm)							Kesici Uç Insert Wendeschneidplatte	Yedek Parçaları / Spare Parts / Ersatzteile	
	R	L	DC	DCON	DCSFMS	LU	LPR	LS	WF		Sıkma Vidası Screw Schraube	Tork Anahtar Torx Key Torx-Schlüssel
AEKR/L-D2.25X8 XC.. 040104	●	●	8	10	12	18	22	38	4			
AEKR/L-D2.25X10 XC.. 050204	●	●	10	12	16	22.5	27.5	42	5	XC.. 040104	3006-M1.8x4	82-T06
AEKR/L-D2.25X12 XC.. 060204	●	●	12	16	20	27	33	45	6	XC.. 050204	3006-M2x4	82-T07
AEKR/L-D2.25X14 XC.. 070304	●	●	14	16	20	31.5	38	45	7	XC.. 060204	3007-M2.2x4.6	
AEKR/L-D2.25X16 XC.. 080304	●	●	16	20	25	36	44	50	8	XC.. 070304	3008-M2.5x6	82-T08
AEKR/L-D2.25X18 XC.. 09T304	●	●	18	25	32	40.5	53.5	56	9	XC.. 080304	3008-M3x6	
AEKR/L-D2.25X20 XC.. 10T304	●	●	20	25	32	45	55	56	10	XC.. 09T304	4015-M3.5x9	80-T15
AEKR/L-D2.25X25 XC.. 130404	●	●	25	32	40	56.5	69	60	12.5	XC.. 10T304	4020-M4.5x10	
AEKR/L-D2.25X32 XC.. 170504	●	●	32	32	50	72	88	60	16	XC.. 130404	4020-M4.5x12	80-T20

CRTZT Ucuna Uygundur. / Compatible with CRTZT Insert. / Kompatibel mit CRTZT Wendeplatten.

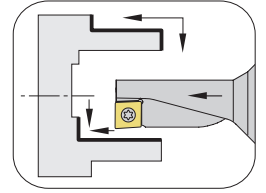
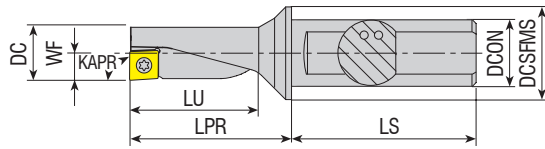
ISCR Ucuna Uygundur. / Compatible with ISCR Insert. / Kompatibel mit ISCR Wendeplatten.



Takım Kodu Ordering Code Bestell-Bezeichnung	Stok Stock Lager		Takım Ölçüleri (mm) Dimension (mm) Abmessung (mm)							Kesici Uç Insert Wendeschneidplatte	Yedek Parçaları / Spare Parts / Ersatzteile	
	R	L	DC	DCON	DCSFMS	LU	LPR	LS	WF		Sıkma Vidası Screw Schraube	Tork Anahtar Torx Key Torx-Schlüssel
AEKR/L-D2.25X8 XC.. 040104	●	●	8	10	12	18	22	38	4			
AEKR/L-D2.25X10 XC.. 050204	●	●	10	12	16	22.5	27.5	42	5	XC.. 040104	3006-M1.8x4	82-T06
AEKR/L-D2.25X12 XC.. 060204	●	●	12	16	20	27	33	45	6	XC.. 050204	3006-M2x4	82-T07
AEKR/L-D2.25X14 XC.. 070304	●	●	14	16	20	31.5	38	45	7	XC.. 060204	3007-M2.2x4.6	
AEKR/L-D2.25X16 XC.. 080304	●	●	16	20	25	36	44	50	8	XC.. 070304	3008-M2.5x6	82-T08
AEKR/L-D2.25X18 XC.. 09T304	●	●	18	25	32	40.5	53.5	56	9	XC.. 080304	3008-M3x6	
AEKR/L-D2.25X20 XC.. 10T304	●	●	20	25	32	45	55	56	10	XC.. 09T304	4015-M3.5x9	80-T15
AEKR/L-D2.25X25 XC.. 130404	●	●	25	32	40	56.5	69	60	12.5	XC.. 10T304	4020-M4.5x10	
AEKR/L-D2.25X32 XC.. 170504	●	●	32	32	50	72	88	60	16	XC.. 130404	4020-M4.5x12	80-T20

R: Sağ / Right / Rechts/ L: Sol / Left / Links

● Stokta / In Stock / Auf Lager ○ Stokta Yok / Non Stock Item / Kein Lagerartikel, Lieferzeit auf Anfrage

ISCR Ucuna Uygundur. / Compatible with ISCR Insert. / Kompatibel mit ISCR Wendeplatten.

Sipariş Örneği/Ordering Example/Bestellbeispiel
1 ad./pcs./stück AEKR-D2.25X8 XC.. 040104

KRLY Ucuna Uygundur. / Compatible with KRLY Insert. / Kompatibel mit KRLY Wendeplatten.

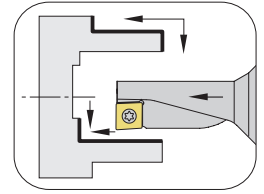
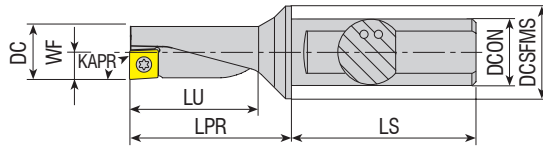

Takım Kodu
Ordering Code
Bestell-Bezeichnung

Stok
Stock
Lager

Takım Ölçüleri (mm)
Dimension (mm)
Abmessung (mm)

Kesici Uç
Insert
Wendeschneidplatte

Yedek Parçaları / Spare Parts / Ersatzteile

Sıkma Vidası
Screw
Schraube

Tork Anahtar
Torx Key
Torx-Schlüssel

R L

DC

DCON

DCSFMS

LU

LPR

LS

WF

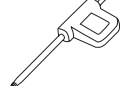

Takım Kodu Ordering Code Bestell-Bezeichnung	R	L	DC	DCON	DCSFMS	LU	LPR	LS	WF	Kesici Uç Insert Wendeschneidplatte	Sıkma Vidası Screw Schraube	Tork Anahtar Torx Key Torx-Schlüssel
AEKR/L-D2.25X8 XC.. 040104	●	●	8	10	12	18	22	38	4	XC.. 040104	3006-M1.8x4	82-T06
AEKR/L-D2.25X10 XC.. 050204	●	●	10	12	16	22.5	27.5	42	5	XC.. 050204	3006-M2x4	82-T07
AEKR/L-D2.25X12 XC.. 060204	●	●	12	16	20	27	33	45	6	XC.. 060204	3007-M2.2x4.6	82-T08
AEKR/L-D2.25X14 XC.. 070304	●	●	14	16	20	31.5	38	45	7	XC.. 070304	3008-M2.5x6	82-T08
AEKR/L-D2.25X16 XC.. 080304	●	●	16	20	25	36	44	50	8	XC.. 080304	3008-M3x6	80-T15
AEKR/L-D2.25X18 XC.. 09T304	●	●	18	25	32	40.5	53.5	56	9	XC.. 09T304	4015-M3.5x9	80-T20
AEKR/L-D2.25X20 XC.. 10T304	●	●	20	25	32	45	55	56	10	XC.. 10T304	4020-M4.5x10	
AEKR/L-D2.25X25 XC.. 130404	●	●	25	32	40	56.5	69	60	12.5	XC.. 130404	4020-M4.5x12	
AEKR/L-D2.25X32 XC.. 170504	●	●	32	32	50	72	88	60	16	XC.. 170504		

KRLY Ucuna Uygundur. / Compatible with KRLY Insert. / Kompatibel mit KRLY Wendeplatten.

TGTC Ucuna Uygundur. / Compatible with TGTC Insert. / Kompatibel mit TGTC Wendeplatten.

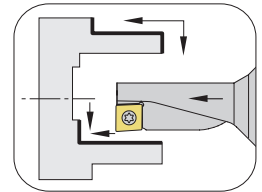
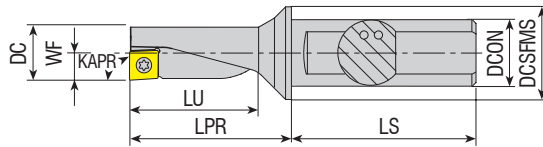

Takım Kodu
Ordering Code
Bestell-Bezeichnung

Stok
Stock
Lager

Takım Ölçüleri (mm)
Dimension (mm)
Abmessung (mm)

Kesici Uç
Insert
Wendeschneidplatte

Yedek Parçaları / Spare Parts / Ersatzteile

Sıkma Vidası
Screw
Schraube

Tork Anahtar
Torx Key
Torx-Schlüssel

R L

DC

DCON

DCSFMS

LU

LPR

LS

WF

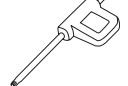

Takım Kodu Ordering Code Bestell-Bezeichnung	R	L	DC	DCON	DCSFMS	LU	LPR	LS	WF	Kesici Uç Insert Wendeschneidplatte	Sıkma Vidası Screw Schraube	Tork Anahtar Torx Key Torx-Schlüssel
AEKR/L-D2.25X8 XC.. 040104	●	●	8	10	12	18	22	38	4	XC.. 040104	3006-M1.8x4	82-T06
AEKR/L-D2.25X10 XC.. 050204	●	●	10	12	16	22.5	27.5	42	5	XC.. 050204	3006-M2x4	82-T07
AEKR/L-D2.25X12 XC.. 060204	●	●	12	16	20	27	33	45	6	XC.. 060204	3007-M2.2x4.6	82-T08
AEKR/L-D2.25X14 XC.. 070304	●	●	14	16	20	31.5	38	45	7	XC.. 070304	3008-M2.5x6	82-T08
AEKR/L-D2.25X16 XC.. 080304	●	●	16	20	25	36	44	50	8	XC.. 080304	3008-M3x6	80-T15
AEKR/L-D2.25X18 XC.. 09T304	●	●	18	25	32	40.5	53.5	56	9	XC.. 09T304	4015-M3.5x9	80-T20
AEKR/L-D2.25X20 XC.. 10T304	●	●	20	25	32	45	55	56	10	XC.. 10T304	4020-M4.5x10	
AEKR/L-D2.25X25 XC.. 130404	●	●	25	32	40	56.5	69	60	12.5	XC.. 130404	4020-M4.5x12	
AEKR/L-D2.25X32 XC.. 170504	●	●	32	32	50	72	88	60	16	XC.. 170504		

R: Sağ / Right / Rechts/ L: Sol / Left / Links

● Stokta / In Stock / Auf Lager ○ Stokta Yok / Non Stock Item / Kein Lagerartikel, Lieferzeit auf Anfrage

TGTC Ucuna Uygundur. / Compatible with TGTC Insert. / Kompatibel mit TGTC Wendeplatten.

Sipariş Örneği/Ordering Example/Bestellbeispiel
1 ad./pcs./stück AEKR-D2.25X8 XC.. 040104

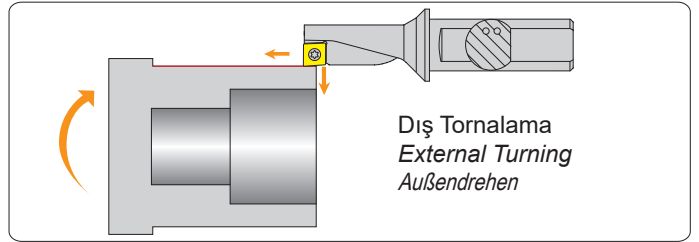
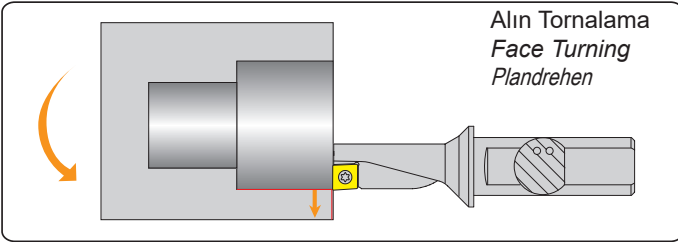
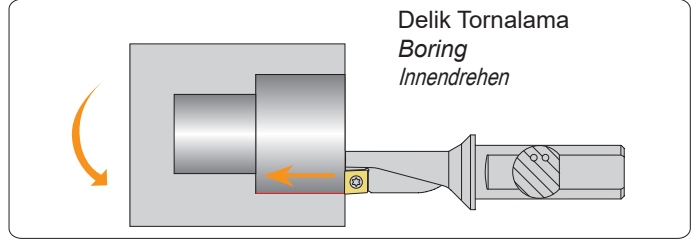
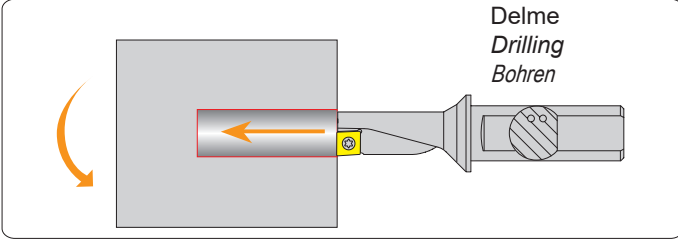
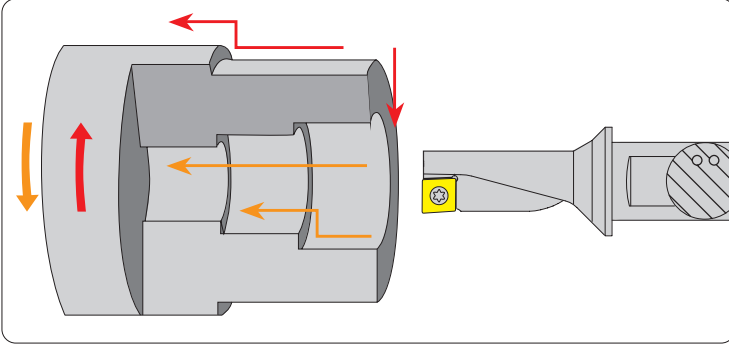

DELİK DELMEDE KUSURSUZLUĞU ARAYANLARA,
TAKMA UÇLU MATKAP SERİSİ
U-DRILL SERIES

U-DRILL-SERIE FÜR ALLE, DIE DAS BOHREN
PERFEKTIONEREN WOLLEN

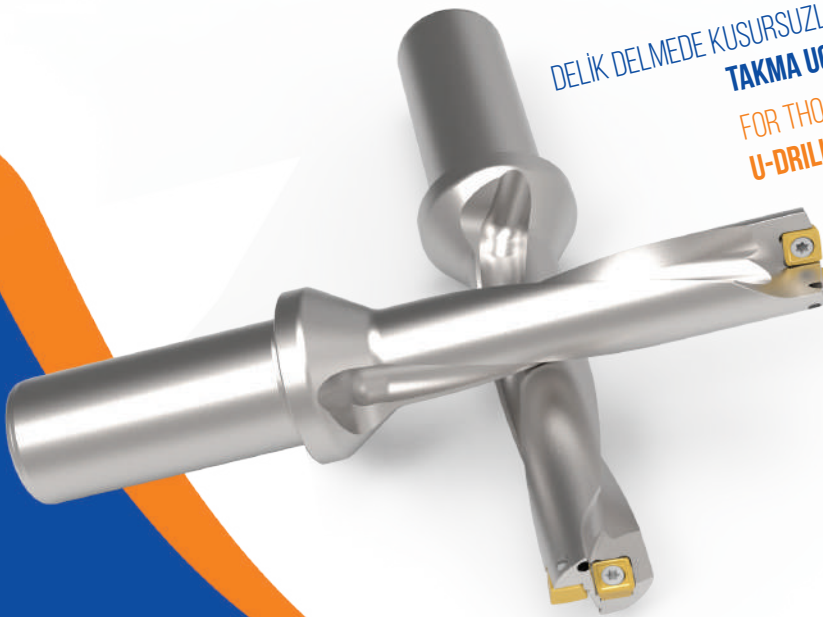

BARALAR

AYARLI DELİK İŞLEME BARALARI
ADJUSTABLE BORING HEADS
EINSTELLBARE SPINDELKÖPFE

*konusulan
the spoken kalite...
quality...*

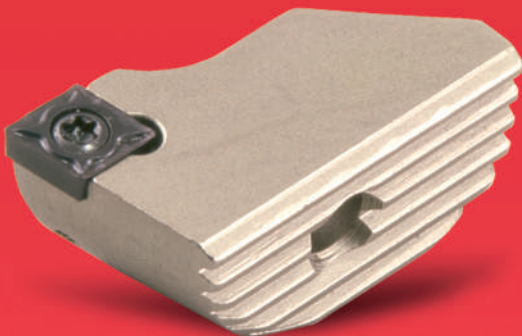

AKKO **A** **BH** **R** - **D18x22**

W16 - **L90** - **CC06**

2 Kesiş Stili / Cutter Style / Werkzeugtyp

BH : Delik İşleme / Boring Head
Spindelkopf

3 İşlem Tipi / Cutter Type / Einsatzgebiet

R : Kaba Baralama / Rough Boring
Schruppbearbeitung
F : Hassas Baralama / Fine Boring
Schlichtbearbeitung

5 Montaj Formu / Assembly Form / Schaffform

W : Weldon

4 Ölçü Aralığı / Boring Range / Bohrbereich

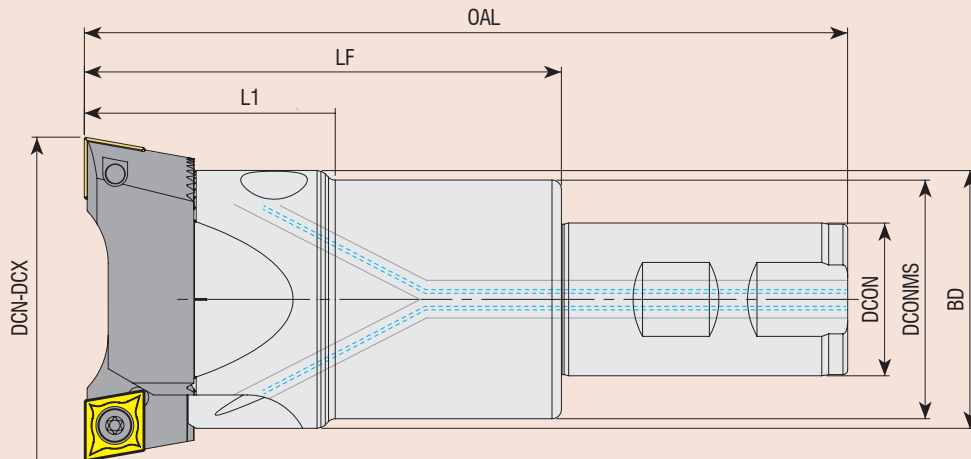

6 Takım Boyu / Tool Length / Werkzeuglänge

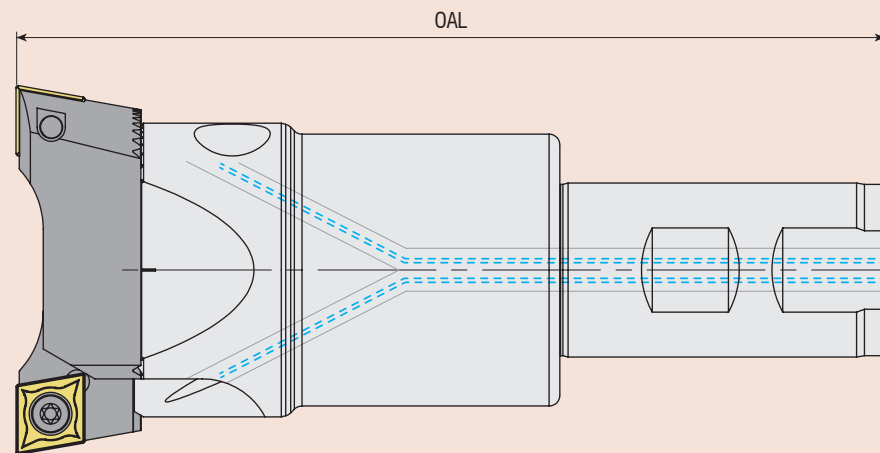

7 Kesici Uç / Insert / Wendeschneidplatte

CC06 : CC.. 0602..
CC09 : CC.. 09T3..
CC12 : CC.. 1204..

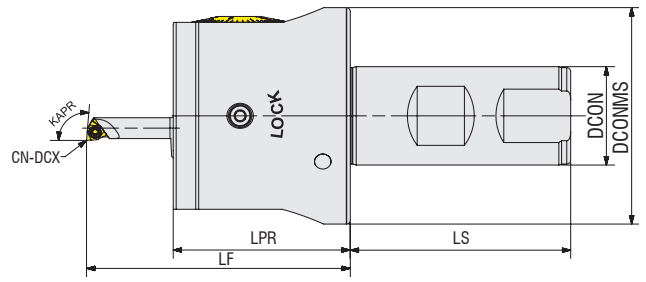

Takım Kodu Ordering Code Bestell-Bezeichnung	Stok Stock Lager	Ölçü Aralığı Boring Range Bohrbereich DCN-DCX	Takım Ölçüleri (mm) Dimension (mm) Abmessung (mm)							Kartuş Cartridge Kurzdrehhalter	Kesici Uç Insert Wendeschneidplatte	Bara Gövde Takım Kodu Boring Head Body Code Trägerwerkzeug-Bezeichnung		
			LF	LPR	LS	DCON	DCONMS	KAPR	DCN				DCX	
SET-I-ABHF-D06X30-WA25	●	06-30	67	45	56	25	55	95°	6	10	SWLCR-D06X10-22	WCGT 0201..L	ABHF-D06X30-WA25	
			75						8	14	SWLCR-D08X14-30			
			85						93°	12	18	STUPR-D12X18-40		TPGX 0902..L
			16							22	STUPR-D16X22-40			
			20							26	STUPR-D20X26-40			
95	24	30	STUPR-D24X30-50											

"Hassas bara setlerimiz 0,2 veya 0,4 radiuslü uçlardan oluşmaktadır. Siparişinizle birlikte uç detayını satış temsilcisi ile paylaşmanızı rica ederiz." "Sipariş örneği: WCGT020102L/WCGT020104L"

"Our fine boring sets consist of inserts with 0.2 or 0.4 radius. We kindly ask you to share the insert radius details with the sales representative with your order."

"Ordering Example:WCGT020102L/WCGT020104L"

"Unsere Einstellbare Bohr Set bestehen aus Wendeschneidplatten mit einem Radius von 0,2 oder 0,4. Wir bitten Sie, die Angaben zum Wendeschneidplattenradius bei Ihrer Bestellung dem Vertriebsmitarbeiter mitzuteilen." "Bestellbeispiel:WCGT020102L/WCGT020104L"

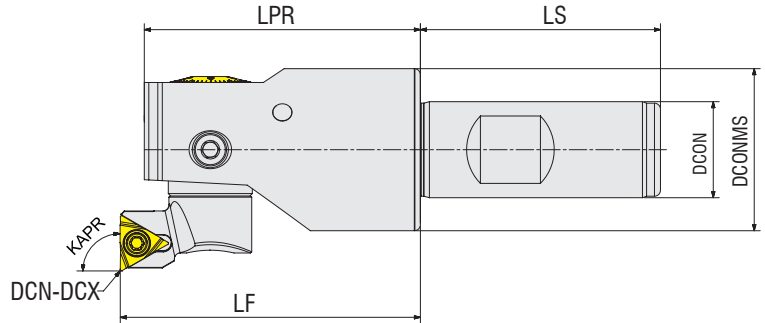

Takım Kodu Ordering Code Bestell-Bezeichnung	Stok Stock Lager	Ölçü Aralığı Boring Range Bohrbereich DCN-DCX	Takım Ölçüleri (mm) Dimension (mm) Abmessung (mm)							Kartuş Cartridge Kurzdrehhalter	Kesici Uç Insert Wendeschneidplatte	Bara Gövde Takım Kodu Boring Head Body Code Trägerwerkzeug-Bezeichnung
			LF	LPR	LS	DCON	DCONMS	KAPR	DCN			
SET-I-ABHF-D29X40-WA16	●	29-40	50	46	40	16	27	29	35	STFPR-D29x35	TPGX 0902..L	ABHF-D29X40-WA16
SET-I-ABHF-D39X54-WA20	●	39-54	60	55	50	20	36	39	47	STFPR-D39x47		
								46	54	STFPR-D46x54		
SET-I-ABHF-D52X80-WA25	●	52-80	70	65	56	25	48	52	68	STFPR-D52x68		
								64	80	STFPR-D64x80		
SET-I-ABHF-D78X170-WA32	●	78-116	83	77	60	32	72	78	98	STFPR-D78x98		
								96	116	STFPR-D96x116		

"Hassas bara setlerimiz 0,2 veya 0,4 radiuslü uçlardan oluşmaktadır. Siparişinizle birlikte uç detayını satış temsilcisi ile paylaşmanızı rica ederiz." "Sipariş örneği: WCGT020102L/WCGT020104L"

"Our fine boring sets consist of inserts with 0.2 or 0.4 radius. We kindly ask you to share the insert radius details with the sales representative with your order."

"Ordering Example:WCGT020102L/WCGT020104L"

"Unsere Einstellbare Bohr Set bestehen aus Wendeschneidplatten mit einem Radius von 0,2 oder 0,4. Wir bitten Sie, die Angaben zum Wendeschneidplattenradius bei Ihrer Bestellung dem Vertriebsmitarbeiter mitzuteilen." "Bestellbeispiel:WCGT020102L/WCGT020104L"

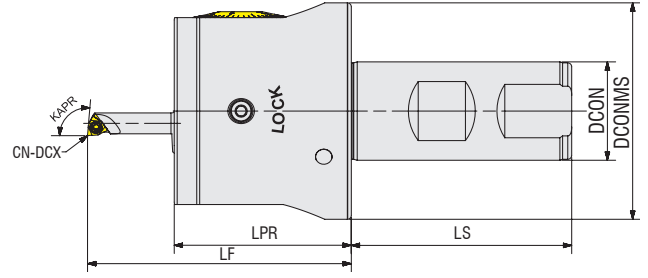

Takım Kodu Ordering Code Bestell-Bezeichnung	Stok Stock Lager	Ölçü Aralığı Boring Range Bohrbereich DCN-DCX	Takım Ölçüleri (mm) Dimension (mm) Abmessung (mm)									Kartuş Cartridge Kurzdrehalter	Kesici Uç Insert Wendeschneidplatte	Bara Gövde Takım Kodu Boring Head Body Code Trägerwerkzeug-Bezeichnung
			LF	LPR	LS	DCON	DCONMS	KAPR	DCN	DCX				
SET-ABHF-D06X30-WA25	●	06-30	85	45	56	25	55	95°	6	10	SWLCR-D06X10-22	WCGT 0201..L	ABHF-D06X30-WA25	
									8	14	SWLCR-D08X14-30			
									93°	12	18	STUPR-D12X18-40		TPGX 0902..L
										16	22	STUPR-D16X22-40		
										20	26	STUPR-D20X26-40		
										24	30	STUPR-D24X30-50		

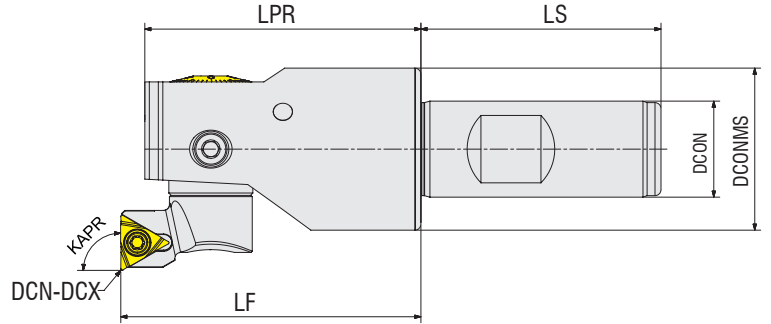

Takım Kodu Ordering Code Bestell-Bezeichnung	Stok Stock Lager	Ölçü Aralığı Boring Range Bohrbereich DCN-DCX	Takım Ölçüleri (mm) Dimension (mm) Abmessung (mm)									Kartuş Cartridge Kurzdrehalter	Kesici Uç Insert Wendeschneidplatte	Bara Gövde Takım Kodu Boring Head Body Code Trägerwerkzeug-Bezeichnung
			LF	LPR	LS	DCON	DCONMS	KAPR	DCN	DCX				
SET-ABHF-D29X40-WA16	●	29-40	50	46	40	16	27	29	35	STFPR-D29x35	TPGX 0902..L	ABHF-D29X40-WA16		
SET-ABHF-D39X54-WA20	●	39-54	60	55	50	20	36	39	47	STFPR-D39x47		ABHF-D39X54-WA20		
								46	54	STFPR-D46x54				
SET-ABHF-D52X80-WA25	●	52-80	70	65	56	25	48	52	68	STFPR-D52x68		ABHF-D52X80-WA25		
								64	80	STFPR-D64x80				
SET-ABHF-D78X170-WA32	●	78-116	83	77	60	32	72	78	98	STFPR-D78x98		ABHF-D78X170-WA32		
								96	116	STFPR-D96x116				

R: Sağ / Right / Rechts/ L: Sol / Left / Links

● Stokta / In Stock / Auf Lager ○ Stokta Yok / Non Stock Item / Kein Lagerartikel, Lieferzeit auf Anfrage

Sipariş Örneği/Ordering Example/Bestellbeispiel

1 ad./pcs./stück SET-ABHF-D06X30-WA25



(figure.1)



(figure.2)

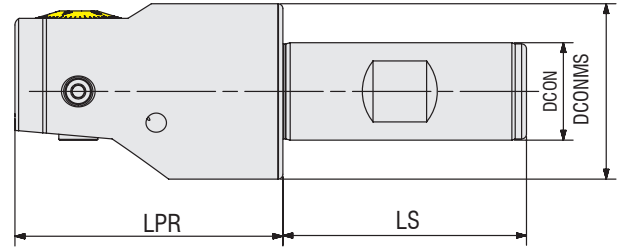

Takım Kodu Ordering Code Bestell-Bezeichnung	Stok Stock Lager	Ölçü Aralığı Boring Range Bohrbereich DCN-DCX	Takım Ölçüleri (mm) Dimension (mm) Abmessung (mm)				Yedek Parçaları / Spare Parts / Ersatzteile			
			LPR	LS	DCON	DCONMS	Anahtar Allen Key Innensechskantschlüssel			
ABHF-D06X30-WA25	(figure.1)	●	06-30	45	56	25	55	AAL-05-4		
ABHF-D29X40-WA16	(figure.2)	●	29-40	46	40	16	27	AAL-01-2	AAL-02-2.5	
ABHF-D39X54-WA20	(figure.2)	●	39-54	55	50	20	36	AAL-02-2.5	AAL-03-3	AAL-05-4
ABHF-D52X80-WA25	(figure.2)	●	52-80	65	56	25	48	AAL-05-4	AAL-07-5	
ABHF-D78X170-WA32	(figure.2)	●	78-170	77	60	32	72	AAL-07-5	AAL-08-6	

R: Sağ / Right / Rechts/ L: Sol / Left / Links

● Stokta / In Stock / Auf Lager ○ Stokta Yok / Non Stock Item / Kein Lagerartikel, Lieferzeit auf Anfrage
Siparişte, gövde ve kartuş set olarak verilecektir. / When ordered, body and cartridge will be sent as set.
Bei Bestellung werden Körper und Kassetten als Set geliefert.

Sipariş Örneği/Ordering Example/Bestellbeispiel
1 ad./pcs./stück ABHF-D06X30-WA25

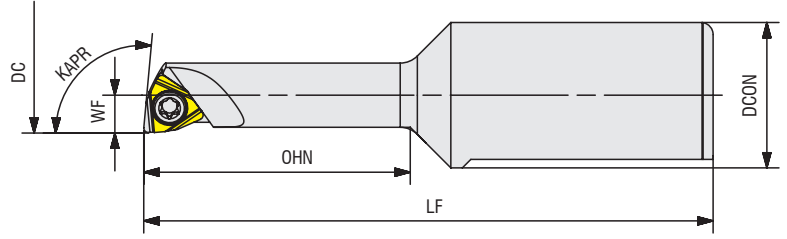

Takım Kodu Ordering Code Bestell-Bezeichnung	Stok Stock Lager	Takım Ölçüleri (mm) Dimension (mm) Abmessung (mm)						Kesici Uç Insert Wendeschneidplatte	Yedek Parçaları / Spare Parts / Ersatzteile	
		DC	WF	KAPR	LF	OHN	DCON		Sıkma Vidası Screw Schraube	Tork Anahtar Torx Key Torx-Schlüssel
SWLCR-D06X10-22	●	6	3	95°	47	22	12	WCGT 020104L	3006-M2x3.3	82-T06
SWLCR-D08X14-30	●	8	4		55	30				

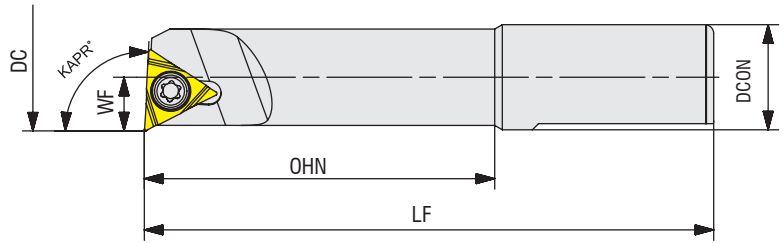

Takım Kodu Ordering Code Bestell-Bezeichnung	Stok Stock Lager	Takım Ölçüleri (mm) Dimension (mm) Abmessung (mm)						Kesici Uç Insert Wendeschneidplatte	Yedek Parçaları / Spare Parts / Ersatzteile				
		DC	WF	KAPR	LF	OHN	DCON		Sıkma Vidası Screw Schraube	Tork Anahtar Torx Key Torx-Schlüssel			
STUPR-D12X18-40	●	12	6	93°	65	40	12	TPGX 090202L	4008-M2.5x4.5	82-T08			
STUPR-D16X22-40	●	16	8										
STUPR-D20X26-40	●	20	10										
STUPR-D24X30-50	●	24	12								75	50	

● Stokta / In Stock / Auf Lager ○ Stokta Yok / Non Stock Item / Kein Lagerartikel, Lieferzeit auf Anfrage
Siparişte, gövde ve kartuş set olarak verilecektir. / When ordered, body and cartridge will be sent as set.
Bei Bestellung werden Körper und Kassetten als Set geliefert.

Sipariş Örneği/Ordering Example/Bestellbeispiel
1 ad./pcs./stück SWLCR-D06X10-22

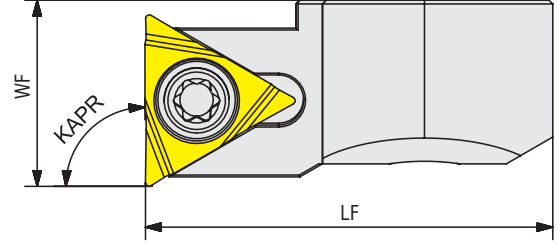

Takım Kodu Ordering Code Bestell-Bezeichnung	Stok Stock Lager	Takım Ölçüleri (mm) Dimension (mm) Abmessung (mm)			Kesici Uç Insert Wendeschneidplatte	Yedek Parçaları / Spare Parts / Ersatzteile	
		WF	KAPR	LF		Sıkma Vidası Screw Schraube	Tork Anahtar Torx Key Torx-Schlüssel
STFPR-D29x35	●	10	90°	21.90	TPGX 090202L	4008-M2.5x6	82-T08
STFPR-D34x40	●	12.50		21.90			
STFPR-D39x47	●	12		26.90			
STFPR-D46x54	●	15.50		26.90			
STFPR-D52x68	●	14		34.90			
STFPR-D64x80	●	20		34.90			
STFPR-D78x98	●	20		44.90			
STFPR-D96x116	●	29		44.90			

HASSAS BARA UZATMA ADAPTÖRÜ
EXTENSION FOR FINE BORING TOOLS
PRÄZISIONSBUSVERLÄNGERUNGSADAPTER

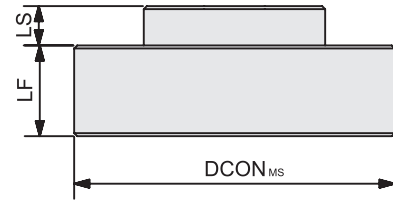

Codice D'ordine Ordering Code Bestell-Bezeichnung	Stok Stock Lager	Dimensioni (mm) Dimension (mm) Abmessung (mm)		
		DCON	LF	LS
AEA-114x134	●	31.80	12.90	9
AEA-132x152	●	31.80	21.90	18

● Stokta / In Stock / Auf Lager ○ Stokta Yok / Non Stock Item / Kein Lagerartikel, Lieferzeit auf Anfrage
Siparişte, gövde ve kartuş set olarak verilecektir. / When ordered, body and cartridge will be sent as set.
Bei Bestellung werden Körper und Kassetten als Set geliefert.

Sipariş Örneği/Ordering Example/Bestellbeispiel
1 ad./pcs./stück STFPR-D29x35

Kartuşların Montajı / Assembling Boring Bar / Kartuschen Montage

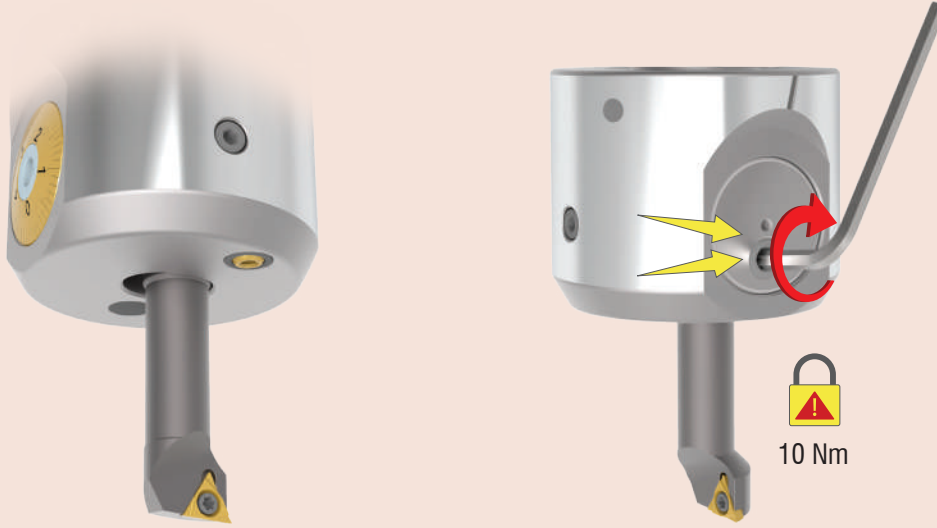

Çap Ayarı / Diameter Adjustment / Umfangeinstellung

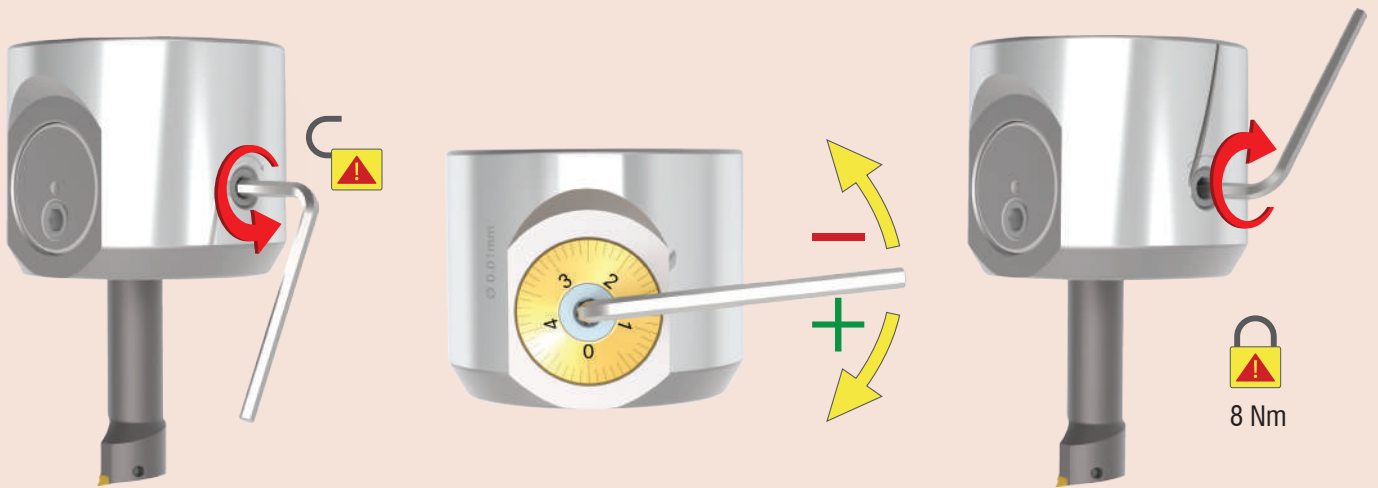

Ölçek / Scale - Vernier / Messaparat

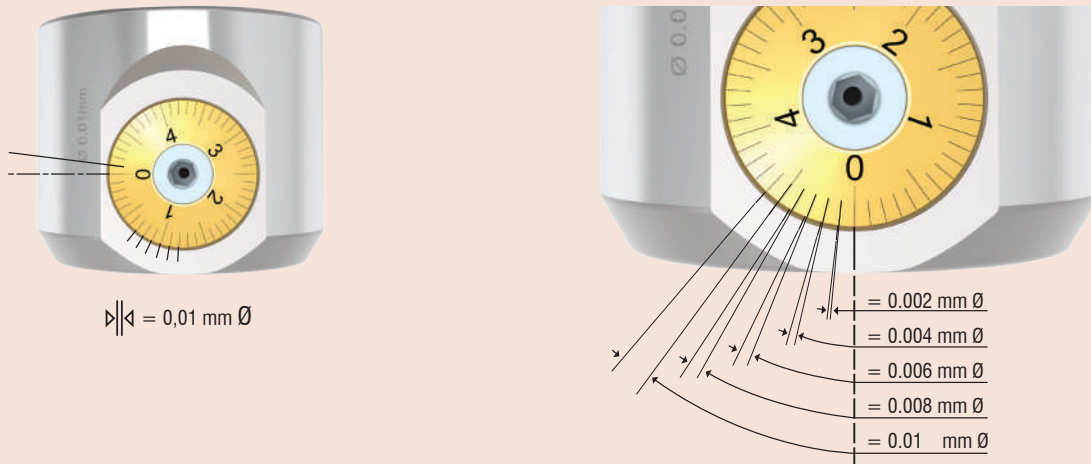

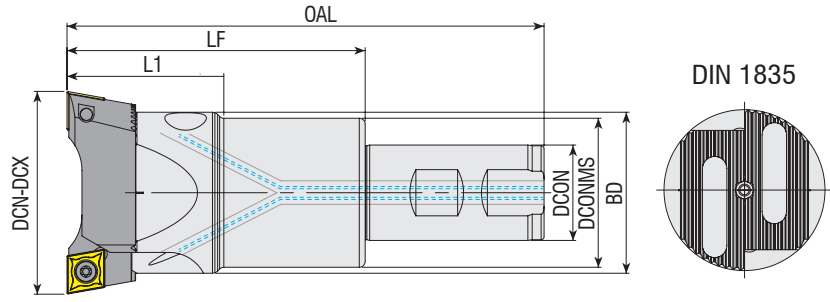

Takım Kodu
Ordering Code
Bestell-Bezeichnung

Stok
Stock
Lager

Ölçü Aralığı
Boring Range
Durchmesser
DCN-DCX

Takım Ölçüleri (mm)
Dimension (mm)
Abmessung (mm)

DCON DCONMS BD OAL LF L1

Kartuş
Cartridge
Kurzdrehhalter



Bara Gövde Takım Kodu
Boring Head Body Code
Trägerwerkzeug-Bezeichnung

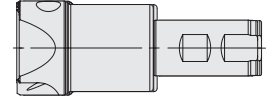

Takım Kodu Ordering Code Bestell-Bezeichnung	Stok Stock Lager	Ölçü Aralığı Boring Range Durchmesser DCN-DCX	DCON	DCONMS	BD	OAL	LF	L1	Kartuş Cartridge Kurzdrehhalter	Bara Gövde Takım Kodu Boring Head Body Code Trägerwerkzeug-Bezeichnung
ABHR-D18x22-W16-L90-CC06	●	18-22	16	-	-	90	42	-	AK.. 18-22	ABHRS-D16x42-W16-L90
ABHR-D18x22-W16-L150-CC06	●	18-22	16	-	-	150	102	-		ABHRS-D16x102-W16-L150
ABHR-D18x22-W16-L200-CC06	●	18-22	16	-	-	200	152	-		ABHRS-D16x152-W16-L200
ABHR-D22x28-W20-L100-CC06	●	22-28	20	-	-	100	50	-	AK.. 22-28	ABHRS-D20x50-W20-L100
ABHR-D22x28-W20-L150-CC06	●	22-28	20	-	-	150	100	-		ABHRS-D20x100-W20-L150
ABHR-D22x28-W20-L200-CC06	●	22-28	20	-	-	200	150	-		ABHRS-D20x150-W20-L200
ABHR-D28x38-W20-L110-CC06	●	28-38	20	25	-	110	60	-	AK.. 28-38	ABHRS-D25x60-W20-L110
ABHR-D28x38-W20-L160-CC06	●	28-38	20	25	-	160	110	-		ABHRS-D25x110-W20-L160
ABHR-D28x38-W20-L230-CC06	●	28-38	20	25	-	230	180	-		ABHRS-D25x180-W20-L230
ABHR-D36x50-W25-L120-CC06	●	36-50	25	32	-	120	64	-	AK.. 36-50	ABHRS-D32x64-W25-L120
ABHR-D36x50-W25-L170-CC06	●	36-50	25	32	-	170	114	-		ABHRS-D32x114-W25-L170
ABHR-D36x50-W25-L250-CC06	●	36-50	25	32	-	250	194	-		ABHRS-D32x194-W25-L250
ABHR-D36x50-W25-L120-CC09	●	36-50	25	32	-	120	64	-	AK.. 36-50-09	ABHRS-D32x64-W25-L120
ABHR-D36x50-W25-L170-CC09	●	36-50	25	32	-	170	114	-		ABHRS-D32x114-W25-L170
ABHR-D36x50-W25-L250-CC09	●	36-50	25	32	-	250	194	-		ABHRS-D32x194-W25-L250
ABHR-D50x68-W32-L140-CC09	●	50-68	32	40	-	140	80	-	AK.. 50-68	ABHRS-D40x80-W32-L140
ABHR-D50x68-W32-L200-CC09	●	50-68	32	40	-	200	140	-		ABHRS-D40x140-W32-L200
ABHR-D50x68-W32-L280-CC09	●	50-68	32	40	-	280	220	-		ABHRS-D40x220-W32-L280
ABHR-D50x68-W32-L140-CC12	●	50-68	32	40	-	140	80	-	AK.. 50-68-12	ABHRS-D40x80-W32-L140
ABHR-D50x68-W32-L200-CC12	●	50-68	32	40	-	200	140	-		ABHRS-D40x140-W32-L200
ABHR-D50x68-W32-L280-CC12	●	50-68	32	40	-	280	220	-		ABHRS-D40x220-W32-L280
ABHR-D68x90-W32-L160-CC12	●	68-90	32	50	54	160	100	50	AK.. 68-90	ABHRS-D50x100-W32-L160
ABHR-D68x90-W32-L210-CC12	●	68-90	32	50	54	210	150	50		ABHRS-D50x150-W32-L210
ABHR-D68x90-W32-L280-CC12	●	68-90	32	50	54	280	220	50		ABHRS-D50x220-W32-L280
ABHR-D90x120-W32-L140-CC12	●	90-120	32	63	72	140	80	63	AK.. 90-120	ABHRS-D63x80-W32-L140
ABHR-D90x120-W40-L200-CC12	●	90-120	40	63	72	200	130	63		ABHRS-D63x130-W40-L200
ABHR-D90x120-W40-L300-CC12	●	90-120	40	63	72	300	230	63		ABHRS-D63x230-W40-L300
ABHR-D120x160-W40-L210-CC12	●	120-160	40	80	95	210	140	75	AK.. 120-160	ABHRS-D80x140-W40-L210
ABHR-D120x160-W40-L300-CC12	●	120-160	40	80	95	300	230	75		ABHRS-D80x230-W40-L300
ABHR-D160x200-W40-L210-B-CC12	●	160-200	40	80	95	210	140	75	AK.. 160-200	ABHRS-D80x140-W40-L210
ABHR-D160x200-W40-L300-B-CC12	●	160-200	40	80	95	300	230	75		ABHRS-D80x230-W40-L300

R: Sağ / Right / Rechts L: Sol / Left / Links

● Stokta / In Stock / Auf Lager ○ Stokta Yok / Non Stock Item / Kein Lagerartikel, Lieferzeit auf Anfrage
Siparişte, gövde ve kartuş set olarak verilecektir. / When ordered, body and cartridge will be sent as set.
Bei Bestellung werden Körper und Kassetten als Set geliefert.

Sipariş Örneği/Ordering Example/Bestellbeispiel
1 ad./pcs./stück ABHR-D18x22-W16-L90-CC06

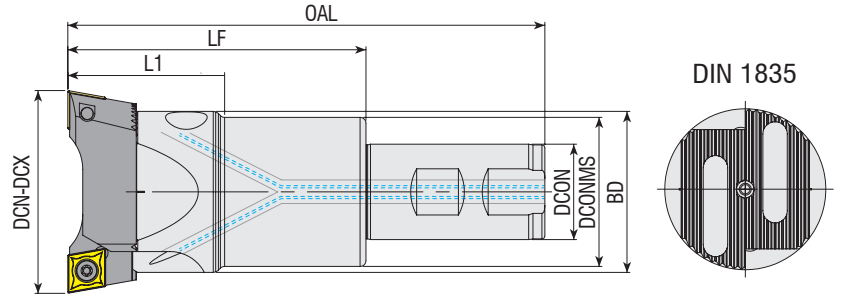

Takım Kodu Ordering Code Bestell-Bezeichnung	Stok Stock Lager	Ölçü Aralığı Boring Range Durchmesser DCN-DCX	Takım Ölçüleri (mm) Dimension (mm) Abmessung (mm)					Yedek Parçaları / Spare Parts / Ersatzteile					
			DCON	DCONMS	BD	OAL	LF	L1	Montaj Vidası Mounting Screw Befestigungsschraube	Montaj Vida Anahtarı Mounting Screw Key Innensechskantschlüssel für Befest.	Pabuç Clamp Spannspratze	Ayar Vidası Adjusting Screw Einstellschraube	Ayar Vida Anahtarı Allen Key Innensechskant-Schlüssel
ABHRS-D16x42-W16-L90	●	18-22	16	-	-	90	42	-					
ABHRS-D16x102-W16-L150	●	18-22	16	-	-	150	102	-	2525-M3x14	AAL-02-2.5	ABKS-D16	2715-M3x4	
ABHRS-D16x152-W16-L200	●	18-22	16	-	-	200	152	-					
ABHRS-D20x50-W20-L100	●	22-28	20	-	-	100	50	-					
ABHRS-D20x100-W20-L150	●	22-28	20	-	-	150	100	-	2503-M4x15	AAL-03-3	ABKS-D20	2715-M3x5	AAL-09-1.5
ABHRS-D20x150-W20-L200	●	22-28	20	-	-	200	150	-					
ABHRS-D25x60-W20-L110	●	28-38	20	25	-	110	60	-					
ABHRS-D25x110-W20-L160	●	28-38	20	25	-	160	110	-	2503-M4x20	AAL-03-3	ABKS-D25	2715-M3x8	
ABHRS-D25x180-W20-L230	●	28-38	20	25	-	230	180	-					
ABHRS-D32X64-W25-L120	●	36-50	25	32	-	120	64	-					
ABHRS-D32X114-W25-L170	●	36-50	25	32	-	170	114	-	2504-M5x25	AAL-05-4	ABKS-D32	2702-M4x12	AAL-01-2
ABHRS-D32X194-W25-L250	●	36-50	25	32	-	250	194	-					
ABHRS-D40x80-W32-L140	●	50-68	32	40	-	140	80	-					
ABHRS-D40x140-W32-L200	●	50-68	32	40	-	200	140	-	2505-M6x30	AAL-07-5	ABKS-D40	2725-M5x16	
ABHRS-D40x220-W32-L280	●	50-68	32	40	-	280	220	-					AAL-02-2.5
ABHRS-D50x100-W32-L160	●	68-90	32	50	54	160	100	50					
ABHRS-D50x150-W32-L210	●	68-90	32	50	54	210	150	50	2506-M8x35	AAL-08-6	ABKS-D50	2725-M5x12	
ABHRS-D50x220-W32-L280	●	68-90	32	50	54	280	220	50					
ABHRS-D63x80-W32-L140	●	90-120	32	63	72	140	80	63					
ABHRS-D63x130-W40-L200	●	90-120	40	63	72	200	130	63	2508-M10x40	AAL-11-8	ABKS-D63	2703-M6x16	AAL-03-3
ABHRS-D63x230-W40-L300	●	90-120	40	63	72	300	230	63					
ABHRS-D80x140-W40-L210	●	120-160	40	80	95	210	140	75					
ABHRS-D80x230-W40-L300	●	120-160	40	80	95	300	230	75	2510-M12x40	AAL-12-10	ABKS-D80	2704-M8x25	AAL-05-4

R: Sağ / Right / Rechts/ L: Sol / Left / Links

● Stokta / In Stock / Auf Lager ○ Stokta Yok / Non Stock Item / Kein Lagerartikel, Lieferzeit auf Anfrage

Sipariş Örneği/Ordering Example/Bestellbeispiel
 1 ad./pcs./stück ABHRS-D16x42-W16-L90

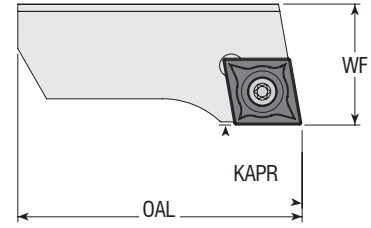

Takım Kodu Ordering Code Bestell-Bezeichnung	Stok Stock Lager	Takım Ölçüleri (mm) Dimension (mm) Abmessung (mm)			Kesici Uç Insert Wendeschneidplatte	Yedek Parçaları / Spare Parts / Ersatzteile		
		Ölçü Aralığı Boring Range	WF	OAL		Sıkma Vidası Screw Schraube	Tork Anahtar Torx Key Torx-Schlüssel	
AKSR 18-22	●	18-22	9	15	CC.T 0602..	4008-M2.5x6	82-T08	
AKSR 22-28	●	22-28	10	19				
AKSR 28-38	●	28-38	13	23				
AKSR 36-50	●	36-50	16	32	CC.T 09T3..	4015-M3.5x8	80-T15	
AKSR 36-50-09	●	36-50	16	32				
AKSR 50-68	●	50-68	20	40				
AKSR 50-68-12	●	50-68	20	40	CC.T 1204..	1020-M5x11	80-T20	
AKSR 68-90	●	68-90	23	54				
AKSR 90-120	●	90-120	28	70				
AKSR 120-160	●	120-160	32	95				
AKSR 160-200	●	160-200	32	120				

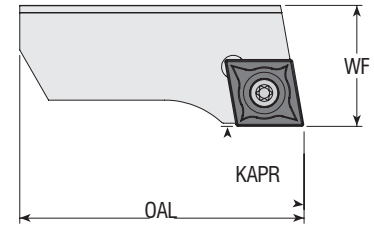

Takım Kodu Ordering Code Bestell-Bezeichnung	Stok Stock Lager	Takım Ölçüleri (mm) Dimension (mm) Abmessung (mm)			Kesici Uç Insert Wendeschneidplatte	Yedek Parçaları / Spare Parts / Ersatzteile		
		Ölçü Aralığı Boring Range	WF	OAL		Sıkma Vidası Screw Schraube	Tork Anahtar Torx Key Torx-Schlüssel	
AKCR 28-38	●	28-38	12.8	23	CC.T 0602..	4008-M2.5x6	82-T08	
AKCR 36-50	●	36-50	15.8	32				
AKCR 36-50-09	●	36-50	15.8	32				
AKCR 50-68	●	50-68	19.7	40	CC.T 09T3..	4015-M3.5x8	80-T15	
AKCR 50-68-12	●	50-68	19.7	40				
AKCR 68-90	●	68-90	22.7	54				
AKCR 90-120	●	90-120	27.7	70	CC.T 1204..	1020-M5x11	80-T20	
AKCR 120-160	●	120-160	31.7	95				
AKCR 160-200	●	160-200	31.7	120				

R: Sağ / Right / Rechtsl L: Sol / Left / Links

● Stokta / In Stock / Auf Lager ○ Stokta Yok / Non Stock Item / Kein Lagerartikel, Lieferzeit auf Anfrage

ISO Ucuna Uygun. / Compatible with ISO Insert. / Kompatibel mit ISO Wendepfatten.

Sipariş Örneği/Ordering Example/Bestellbeispiel

1 ad./pcs./stück AKSR 18-22

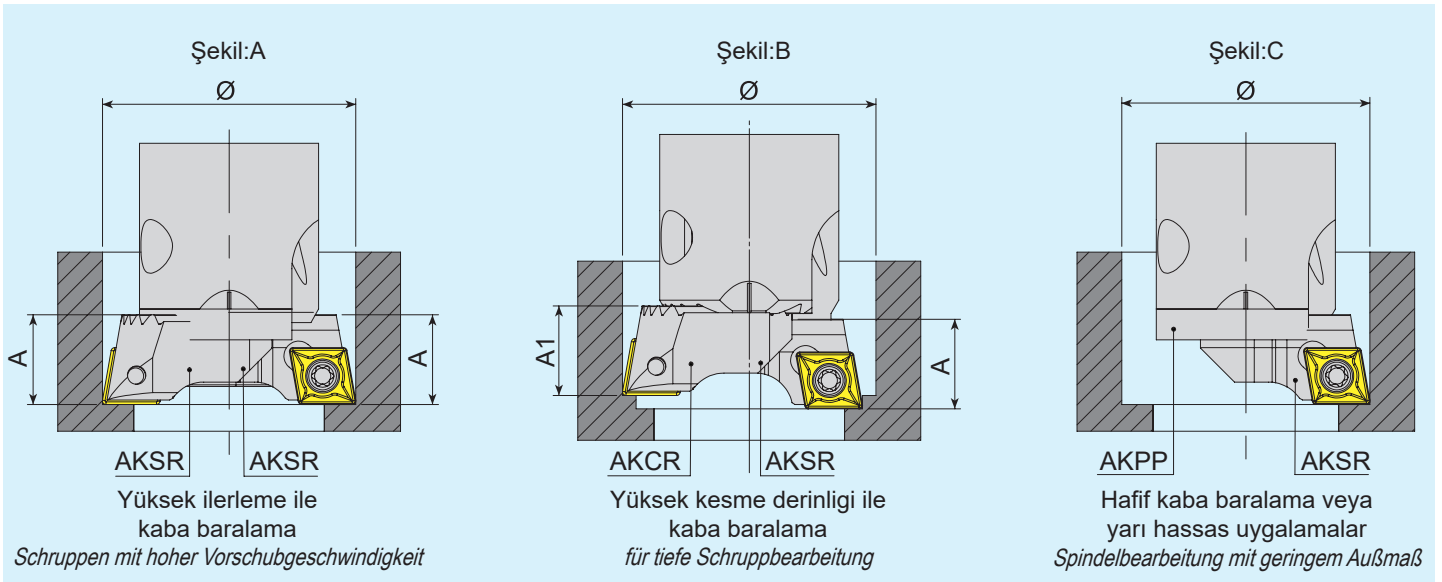

1. Kesici kenarların radyal ayarı, takım ölçme ekipmanı ile yapılmalıdır.
2. İki uçlu baralama takımı, ağır talaş kaldırma işlemini içeren kaba baralama işlemleri içindir. Çift uçlu baralama takımı ile:
 - Yüksek ilerleme oranında kaba baralama işlemleri için, aynı düzlemden iki AKSR kartuşu, aynı radyal mesafeye ayarlanır. (Şekil A)
 - Aynı düzlemde olmayan bir AKCR kartuşu ve bir AKSR kartuşu yüksek derinlikte kaba baralama işlemleri için kullanılır. (Şekil B)
 - i. Kaba baralama işleminde, alınacak paso miktarı tam olarak ikiye bölünüp, düzgün bir kesim sağlanmış olur, ancak bu durumda tur başına ilerleme tek ağız olarak hesaplanmalıdır. ($f=f_1$)
 - ii. Hassas baralama işleminde, alınacak paso miktarı AKSR kartuş için ara kaba olarak ve AKCR kartuş için hassas baralama olarak çaplar ayarlanır ve bu sayede bazı ara kaba işleme ihtiyacı kalmaz.
3. Tek kartuşlu baralama takımları, normal talaş kaldırma işlemini içeren kaba ve hassas baralama işlemleri içindir. Dişleri koruma plakası, AKPP daima kullanılmalıdır. (Şekil C)

1. Radial setting of the cutting edges should be carried out with tool presetting equipment.
2. Boring bars fitted with two insert pockets are for roughing operations involving heavy chip removal. The double-insert boring bars include:
 - Two AKSR cartridges on the same plane with two cutting edges set at identical radial distance for high feed rate roughing operations. (fig. A)
 - An AKCR cartridge and an AKSR cartridge not on the same plane for high-depth roughing operations. (fig. B)
 - i. With the rough boring operation, this allows double the cutting width, using only a single feed rate. ($f=f_1$)
 - ii. With the finish boring operation, the cutting width is divided so that some of the intermediate machining can be omitted.
3. Boring bars fitted with a single cartridge are for roughing and finishing operations involving normal chip removal. The serrated surface protection plate AKPP should always be used (fig. C)

1. Die radiale Einstellung der Schneiden sollte auf einem Voreinstellgerät durchgeführt werden.
2. Spindelköpfe, die mit 2 Kassetten bestückt sind, werden für die Schrubbearbeitung eingesetzt. Doppelte Kassetten beinhalten:
 - Für die Schrubbearbeitung mit hoher Vorschubgeschwindigkeit sind zwei AKSR-Kassetten in derselben Höhe auf denselben radialen Abstand einzustellen (Abbildung A)
 - Eine AKCR-Kassette und eine AKSR-Kassette, die nicht in derselben Ebene liegen, werden für tiefe Schrubbearbeitungen eingesetzt.
 - i. Bei einer Schrubbearbeitung kann die Schnitttiefe verdoppelt werden. Bitte nur eine Schneide zur Vorschubberechnung verwenden ($f=f_1$).
 - ii. Bei der Schlichtbearbeitung wird die Schnitttiefe halbiert. Weitere zusätzliche Bearbeitungsdurchgänge werden überflüssig.
3. Bohrköpfe mit einer einzelnen Kassette können sowohl für Schlicht- als auch für Schrubb-Operationen eingesetzt werden. Voraussetzung hierfür ist eine gute Spanabfuhr. Zum Schutz der verzahnten Oberfläche des Bohrkörpers sollte immer die Abdeckung AKPP verwendet werden (siehe Abb.C).





AYARLI HASSAS DELİK
İŞLEME BARALARI
ADJUSTABLE FINISH
BORING HEADS
EINSTELLBARE
BOHRKÖPFE

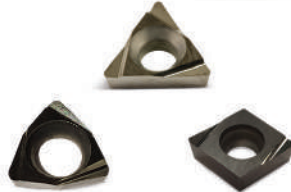

www.akkocom.tr

konuşulan
the spoken kalite...
quality...

konusulan
the spoken kalite...
quality...

FREZELEME TAKIMLARI
MILLING TOOLS
FRÄSWERKZEUGE





AKKO **A** **EM** **90** **L** - **A** **P** **10**

1 2 3 4 5 6 7

D12 - **W16** - **L100** - **Z01** - **H**

8 9 10 11 12

2 Kesiş Stili / Cutter Style / Fräswerkzeug-Typ

FM: Yüzey Frezeleme Takımları / Face Milling Tools / *Eck-und Planfräsköpfe*
EM: Alın ve Yüzey Parmak Frezeleri / End Face Milling Tools / *Schaftfräser*
CM: Pah Kırma Parmak Frezeleri / Chamfering End Milling Tools / *Fasfräser*
HM: Helis Parmak Frezeleri / Helix End Milling Tools / *Schaftfräser Helix*
TSM: T Kanal Frezeleri / T Slot Milling Tools / *T-Nutenfräser*
HFM: Yüksek İlerleme Frezeleme Takımları / High Feed Milling Tools / *Fräser für hohe Vorschübe*
PMR: Küresel Uçlu Parmak Frezeleri / Ball Nose End Milling Tools / *Kugel und Kopierfräser*
SDM: Disk Frezeler / Slot Disc Milling / *Scheibenfräser*
CBM: Silindirik Alyan Başlı Vida Havşalarını Açma Frezeleri / Countersink Milling Tool for Cylindrical Allen Head Screws
Fräswerkzeug für zylindrische Inbusschrauben

3 Freze Yanaşma Açısı / Lead Angle / Anstellwinkel

90° - 75° - 60° - 45°
20° - 15° - 11° - 5° - 0°

4 Freze Yanaşma Açısı / Lead Angle / Ausführung

L: Sol - Left / Links
C: Baskı Pabucu - Clamp / Spannpratze
S: Altlık - Shim / Unterlage
CL: Baskı Pabuçlu Sol Yön - Left Way with Clamp
Spannspratze links
CS: Baskı Pabuçlu Altlıklı - Clamp with Shim
Spannspratze mit Unterlage
CSL: Baskı Pabuçlu Altlıklı Sol Yön - Left Way Clamp with Shim
Spannspratze mit Unterlage Links

5 Uç Tipi / Type of Insert / Plattenform

C	D	E	K
L	R	S	T
V	W	A	B
H	M	O	P

6 Serbest Uç Açısı / Clearance angle of Insert
Freiwinkel der Wendeschneidplatte

A	B	C
D	E	F
G	N	P

7 Kesme Kenar Uzunluğu
Cutting Edge Length
Länge der Schneidkante

A	L
R	S
T	

8 Takım Çapı / Tool Diameter / Werkzeug-ø

9 Montaj Formu ve Çapı / Assembly Form and Diameter / Schaft-ø und Form

A,B,C,D: ISO'ya göre montaj formu / Assembly Form and Diameter / Art der Montage und Durchmesser
Silindirik Şaft / Cylindrical Shank / Zylindrischer Schaft
W: Weldon

10 Takım Boyu / Tool Length / Werkzeug Länge

11 Etkili Diş Adedi / Number of Effective Tooth / Effektive Zahnzahl

12 İçten Soğutmalı / With Coolant Hole / Innenkühlung

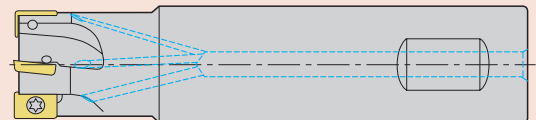

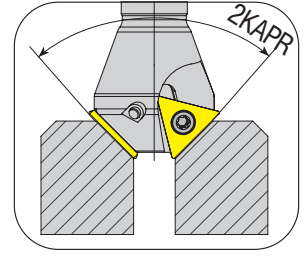
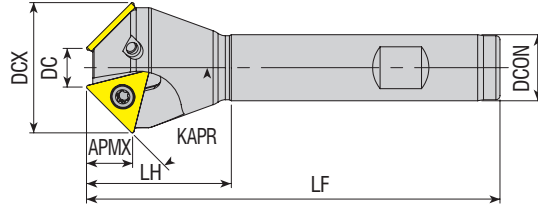

Takım Kodu Ordering Code Bestell-Bezeichnung	Stok Stock Lager	Takım Ölçüleri (mm) Dimension (mm) Abmessung (mm)								Kesici Uç Insert Wendeschneidplatte	Yedek Parçaları / Spare Parts / Ersatzteile	
		KAPR	DC	DCX	DCON	LF	LH	ZEFP	APMX		Sıkma Vidası Screw Schraube	Tork Anahtar Torx Key Torx-Schlüssel
ACM10-TC16-D17X22-W16-L90-Z01	●	10°	17	22	16	90	30	1	15.2	TC.T 16T304	4015-M3.5x9	80-T15
ACM15-TC16-D17X24-W16-L90-Z01	●	15°	17	24	16	90	30	1	14.9			
ACM15-TC16-D22X29-W16-L100-Z01	●	15°	22	29	16	100	30	1	14.9			
ACM15-TC16-D30X37-W20-L100-Z02	●	15°	30	37	20	100	35	2	14.9			
ACM15-TC16-D35X42-W20-L100-Z03	●	15°	35	42	20	100	38	3	14.9			
ACM15-TC16-D52X59-W25-L110-Z03	●	15°	52	59	25	110	40	3	14.9			
ACM17.5-TC16-D17X25-W16-L90-Z01	●	17.5°	17	25	16	90	30	1	14.7			
ACM18.5-TC16-D21.3X30-W20-L100-Z02	●	18.5°	21.3	30	20	100	30	2	13.5			
ACM19.5-TC16-D17X27-W16-L100-Z01	●	19.5°	17	27	16	100	30	1	14.5			
ACM20-TC16-D12X22-W16-L100-Z01	●	20°	12	22	16	100	30	1	14.4			
ACM20-TC16-D17X27-W16-L100-Z01	●	20°	17	27	16	100	30	1	14.4			
ACM20-TC16-D23X33-W20-L100-Z02	●	20°	23	33	20	100	30	2	14.4			
ACM20-TC16-D28X38-W20-L100-Z02	●	20°	28	38	20	100	35	2	14.4			
ACM20-TC16-D35X45-W20-L100-Z03	●	20°	35	45	20	100	40	3	14.4			
ACM20-TC16-D39X49-W20-L100-Z03	●	20°	39	49	20	100	40	3	14.4			
ACM20-TC16-D45X55-W25-L110-Z03	●	20°	45	55	25	110	40	3	14.4			
ACM20-TC16-D51X61-W25-L110-Z03	●	20°	51	61	25	110	40	3	14.4			
ACM22.5-TC16-D17X28-W16-L100-Z01	●	22.5°	17	28	16	100	30	1	14.2			
ACM25-TC16-D17X29-W16-L100-Z01	●	25°	17	29	16	100	30	1	13.9			
ACM30-TC16-D6X20-W16-L100-Z01	●	30°	6	20	16	100	30	1	13.3	TC.T 090204	3007-M2.2x4.6	82-T07
ACM30-TC16-D15X30-W16-L100-Z01	●	30°	15	30	16	100	30	1	13.3			
ACM30-TC16-D17.5X32.5-W20-L100-Z02	●	30°	17.5	32.5	20	100	30	2	13.3			
ACM30-TC16-D20X35-W16-L100-Z02	●	30°	20	35	16	100	35	2	13.3			
ACM30-TC16-D30X45-W20-L100-Z02	●	30°	30	45	20	100	40	2	13.3			
ACM30-TC16-D35X50-W20-L100-Z03	●	30°	35	50	20	100	40	3	13.3			
ACM30-TC16-D45X60-W25-L110-Z03	●	30°	45	60	25	110	40	3	13.3			
ACM40-TC16-D18x37-W20-L100-Z02	●	40°	18	37	20	100	40	2	11.7			
ACM45-TC09-D7X18-W16-L100-Z02	●	45°	7	18	16	100	25	2	5.9			
ACM45-TC11-D8X21.5-W16-L90-Z02	○	45°	8	21.5	16	90	20	2	6.9			
ACM45-TC11-D11X24-W16-L100-Z02	●	45°	11	24	16	100	25	2	6.9			
ACM45-TC16-D5X26-W16-L100-Z01	●	45°	5	26	16	100	30	1	10.8	TC.T 16T304	4015-M3.5x9	80-T15
ACM45-TC16-D10X31-W16-L100-Z02	●	45°	10	31	16	100	35	2	10.8			
ACM45-TC16-D10X31-W20-L100-Z02	●	45°	10	31	20	100	35	2	10.8			
ACM45-TC16-D14X35-W20-L100-Z02	●	45°	14	35	20	100	35	2	10.8			
ACM45-TC16-D18X39-W16-L100-Z02	●	45°	18	39	16	100	40	2	10.8			
ACM45-TC16-D18X39-W20-L100-Z02	●	45°	18	39	20	100	40	2	10.8			
ACM45-TC16-D20X41-W20-L100-Z02	●	45°	20	41	20	100	40	2	10.8			
ACM45-TC16-D30X51-W20-L100-Z02	●	45°	30	51	20	100	40	2	10.8			
ACM50-TC16-D16X39-W20-L100-Z03	●	50°	16	39	20	100	40	3	9.8			
ACM55-TC16-D16X40-W20-L100-Z03	●	55°	16	40	20	100	40	3	8.7			
ACM62-TC16-D14X40-W20-L100-Z03	●	62°	14	40	20	100	40	3	7.1	TC.T 16T304	4015-M3.5x9	80-T15
ACM72-TC16-D14X42-W20-L100-Z03	●	72°	14	42	20	100	40	3	4.6			

R: Sağ / Right / Rechts/ L: Sol / Left / Links

● Stokta / In Stock / Auf Lager ○ Stokta Yok / Non Stock Item / Kein Lagerartikel, Lieferzeit auf Anfrage

ISO Ucuna Uygundur. / Compatible with ISO Insert. / Kompatibel mit ISO Wendeplatten.

Sipariş Örneği/Ordering Example/Bestellbeispiel

1 ad./pcs./stück ACM10-TC16-D17X22-W16-L90-Z01

Kesme Hesabı : S 429 / Cutting Calculation : P 429 / Schnittberechnung : P 429

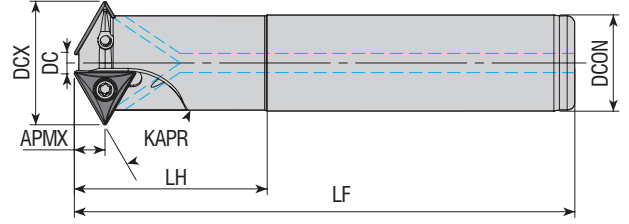

Takım Kodu Ordering Code Bestell-Bezeichnung	Stok Stock Lager	Takım Ölçüleri (mm) Dimension (mm) Abmessung (mm)								Kesici Uç Insert Wendeschneidplatte	Yedek Parçaları / Spare Parts / Ersatzteile		
		KAPR	DCX	DCON	DC	LF	LH	ZEFP	APMX		Sıkma Vidası Screw Schraube	Tork Anahtar Torx Key Torx-Schlüssel	
ATM60-TB0601-D13-C10-L150-Z02-H	●	60	13	10	2.5	150	40	2	3.3	TBGT 060102	3006-M2x4	82-T06	
ATM60-TC0902-D20.5-C16-L150-Z02-H	●	60	20.5	16	5.2	150	40	2	4.7	TC.T 090202	3007-M2.2x4.6	82-T07	
ATM60-TC1102-D26-C20-L150-Z03-H	●	60	26	20	8.3	150	50	3	5.4	TC.T 110202	3008-M2.5x6	82-T08	
ATM60-TC16T3-D32-C25-L150-Z02-H	●	60	32	25	6.4	150	50	2	8	TC.T 16T304	4015-M3.5x9	80-T15	
ATM60-TC16T3-D40-C32-L250-Z03-H	●	60	40	32	13.7	250	50	3	8				

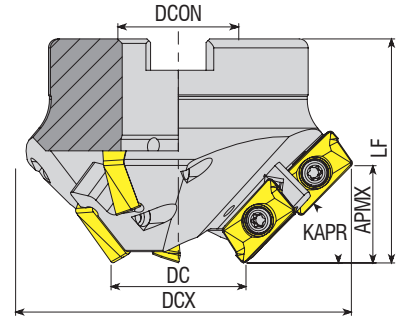

Takım Kodu Ordering Code Bestell-Bezeichnung	Stok Stock Lager	Takım Ölçüleri (mm) Dimension (mm) Abmessung (mm)								Kesici Uç Insert Wendeschneidplatte	Yedek Parçaları / Spare Parts / Ersatzteile			
		ZEFP		KAPR	DC	DCX	DCON	APMX	LF		Sıkma Vidası Screw Schraube	Tork Anahtar Torx Key Torx-Schlüssel	Montaj Vidası Mounting Screw Befestigungsschraube	
		Toplam Total Gesamt	Etkili Effective Effektiv											
AHM15-AP16-D35x93-A27-Z0306-H	●	6	3	15	35	93	27	31.5	50	AP. 1604..	4015-M4x11	80-T15	2408-M12X35	
AHM30-AP16-D35x87-A27-Z0306-H	●	6	3	30	35	87	27	15	50					
AHM45-AP16-D35x77-A27-Z0306-H	●	6	3	45	35	77	27	21.5	50					
AHM60-AP16-D35x65-A22-Z0306-H	●	6	3	60	35	65	22	26.5	50					
AHM75-AP16-D35x50-A22-Z0306-H	●	6	3	75	35	50	22	29.5	50					2508-M10X30

R: Sağ / Right / Rechts/ L: Sol / Left / Links

● Stokta / In Stock / Auf Lager ○ Stokta Yok / Non Stock Item / Kein Lagerartikel, Lieferzeit auf Anfrage

ISO Ucuna Uygundur. / Compatible with ISO Insert. / Kompatibel mit ISO Wendeplatten.

Sipariş Örneği/Ordering Example/Bestellbeispiel/

1 ad./pcs./stück ATM60-TB0601-D13-C10-L150-Z02-H

Kesme Hesabı : S 429 / Cutting Calculation : P 429 / Schnittberechnung : P 429

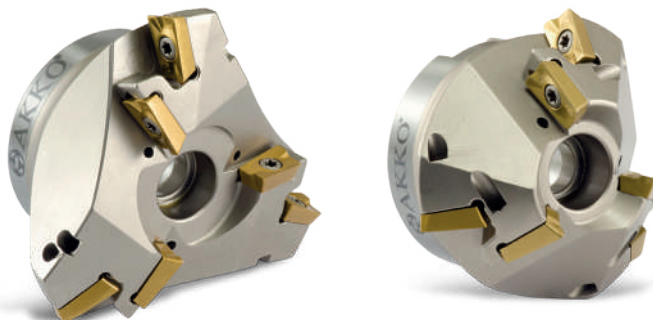

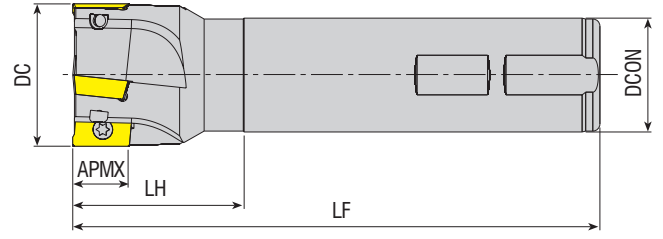

Takım Kodu
Ordering Code
Bestell-Bezeichnung

Stok
Stock
Lager

Takım Ölçüleri (mm)
Dimension (mm)
Abmessung (mm)

Kesici Uç
Insert
Wendeschneidplatte

Yedek Parçaları / Spare Parts / Ersatzteile

Sıkma Vidası
Screw
Schraube

Tork Anahtar
Torx Key
Torx-Schlüssel

DC ZEFP DCON LF LH APMX

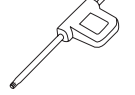

AEM90-AP10-D10-C10-L100-Z01	●	10	1	10	100	20	10
AEM90-AP10-D12-C16-L100-Z01-H	●	12	1	16	100	30	10
AEM90-AP10-D12-W16-L100-Z01-H	●	12	1	16	100	30	10
AEM90-AP10-D12-W16-L150-Z01	●	12	1	16	150	38	10
AEM90-AP10-D14-W16-L100-Z01-H	●	14	1	16	100	30	10
AEM90-AP10-D14-W16-L150-Z01	●	14	1	16	150	38	10
AEM90-AP10-D16-C16-L100-Z02-H	●	16	2	16	100	30	10
AEM90-AP10-D16-W16-L85-Z02-H	●	16	2	16	85	30	10
AEM90-AP10-D16-W16-L100-Z02-H	●	16	2	16	100	30	10
AEM90-AP10-D16-W16-L150-Z02-H	●	16	2	16	150	50	10
AEM90-AP10-D16-W16-L200-Z02	●	16	2	16	200	100	10
AEM90-AP10-D16-C16-L120-Z02-H	●	16	2	16	120	30	10
new AEM90-AP10-D16-C16-L250-Z02-H	●	16	2	16	250	200	10
AEM90-AP10-D16-C16-L150-Z02	●	16	2	16	150	50	10
AEM90-AP10-D16-C16-L150-Z02-H	●	16	2	16	150	50	10
AEM90-AP10-D16-W16-L150-Z02	●	16	2	16	150	50	10
AEM90-AP10-D16-C16-L200-Z02	●	16	2	16	200	100	10
AEM90-AP10-D16-C16-L200-Z02-H	●	16	2	16	200	100	10
AEM90-AP10-D16-C16-L250-Z02	●	16	2	16	250	30	10
AEM90-AP10-D17-C16-L150-Z02	●	17	2	16	150	150	10
AEM90-AP10-D18-W16-L100-Z02-H	●	18	2	16	100	30	10
AEM90-AP10-D18-W16-L150-Z02	●	18	2	16	150	30	10
AEM90-AP10-D20-C19-L180-Z02	●	20	2	19	180	30	10
AEM90-AP10-D20-C20-L100-Z03-H	●	20	3	20	100	30	10
AEM90-AP10-D20-W20-L90-Z03-H	●	20	3	20	90	30	10
AEM90-AP10-D20-W20-L100-Z03-H	●	20	3	20	100	30	10
AEM90-AP10-D20-C20-L120-Z03-H	●	20	3	20	120	30	10
AEM90-AP10-D20-C20-L150-Z03	●	20	3	20	150	50	10
AEM90-AP10-D20-C20-L150-Z03-H	●	20	3	20	150	50	10
AEM90-AP10-D20-W20-L150-Z03	●	20	3	20	150	50	10
AEM90-AP10-D20-C20-L200-Z02	●	20	2	20	200	100	10
AEM90-AP10-D20-C20-L200-Z03-H	●	20	3	20	200	100	10
AEM90-AP10-D20-C20-L250-Z02	●	20	2	20	250	150	10
AEM90-AP10-D20-C20-L250-Z02-H	●	20	2	20	250	150	10
AEM90-AP10-D20.5-C20-L90-Z03	●	20.5	3	20	90	30	10
AEM90-AP10-D21-C20-L150-Z03	●	21	3	20	200	35	10
AEM90-AP10-D21-C20-L200-Z03	●	21	3	20	200	30	10
AEM90-AP10-D21-C20-L200-Z03-H	●	21	3	20	200	35	10
AEM90-AP10-D21-W20-L150-Z03	●	21	3	20	150	30	10
AEM90-AP10-D22-W20-L100-Z03-H	●	22	3	20	100	30	10
AEM90-AP10-D22-W20-L150-Z03	●	22	3	20	150	30	10
AEM90-AP10-D22.5-W20-L150-Z03	●	22.5	3	20	150	30	10
AEM90-AP10-D23-W20-L150-Z03	●	23	3	20	150	30	10
AEM90-AP10-D24-W20-L150-Z03	●	24	3	20	150	30	10
AEM90-AP10-D25-W25-L100-Z04-H	●	25	4	25	100	30	10
AEM90-AP10-D25-W25-L95-Z04-H	●	25	4	25	95	30	10
AEM90-AP10-D25-W25-L150-Z04-H	●	25	4	25	150	50	10

AP. 1003..

3008-M2.5x5

82-T08

3008-M2.5x6



ISO Ucuna Uygundur. / Compatible with ISO Insert. / Kompatibel mit ISO Wendeplatten.

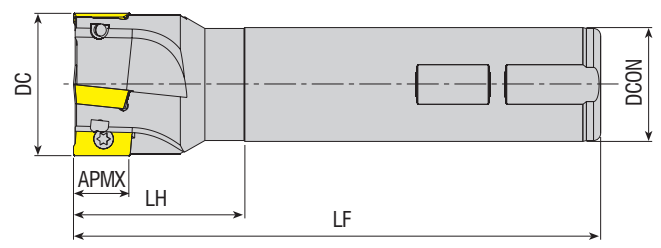

Takım Kodu Ordering Code Bestell-Bezeichnung	Stok Stock Lager	Takım Ölçüleri (mm) Dimension (mm) Abmessung (mm)						Kesici Uç Insert Wendeschneidplatte	Yedek Parçaları / Spare Parts / Ersatzteile		
		DC	ZEPF	DCON	LF	LH	APMX		Sıkma Vidası Screw Schraube	Tork Anahtar Torx Key Torx-Schlüssel	
AEM90-AP10-D25-C25-L100-Z03-H	●	25	3	25	100	30	10	AP. 1003..	3008-M2.5x6	82-T08	
AEM90-AP10-D25-W25-L100-Z03-H	●	25	3	25	100	30	10				
AEM90-AP10-D25-C25-L120-Z03-H	●	25	3	25	120	30	10				
AEM90-AP10-D25-C25-L150-Z03	●	25	3	25	150	50	10				
AEM90-AP10-D25-W25-L150-Z03	●	25	3	25	150	50	10				
AEM90-AP10-D25-C25-L200-Z02	●	25	2	25	200	100	10				
AEM90-AP10-D25-C25-L200-Z03	●	25	3	25	200	100	10				
AEM90-AP10-D25-C25-L250-Z02	●	25	2	25	250	100	10				
AEM90-AP10-D26-C25-L200-Z04	●	26	4	25	200	35	10				
AEM90-AP10-D30-C25-L100-Z04-H	●	30	4	25	100	30	10				
AEM90-AP10-D30-C25-L120-Z04-H	●	30	4	25	120	30	10				
AEM90-AP10-D30-C25-L150-Z04	●	30	4	25	150	30	10				
AEM90-AP10-D32-C25-L100-Z04-H	●	32	4	25	100	35	10				
AEM90-AP10-D32-C25-L120-Z04-H	●	32	4	25	120	35	10				
AEM90-AP10-D32-C25-L150-Z04	●	32	4	25	150	35	10				
AEM90-AP10-D32-W25-L150-Z04	●	32	4	25	150	35	10				
new AEM90-AP10-D32-C32-L120-Z04-H	●	32	4	32	120	35	10				
AEM90-AP10-D32-C32-L170-Z04	●	32	4	32	170	50	10				
AEM90-AP10-D32-W25-L105-Z05-H	●	32	5	25	105	35	10				
AEM90-AP10-D32-C32-L130-Z05	●	32	5	32	130	30	10				
new AEM90-AP10-D32-W32-L120-Z04-H	●	32	4	32	120	35	10				
AEM90-AP10-D32-W32-L150-Z04	●	32	4	32	150	50	10				
AEM90-AP10-D40-W32-L150-Z05	●	40	5	32	150	40	10				
AEM90-AP16-D25-C20-L100-Z02	●	25	2	20	100	35	16	AP. 1604..	4015-M4x9	80-T15	
new AEM90-AP16-D25-C20-L100-Z02-H	●	25	2	20	100	35	16				
AEM90-AP16-D25-W25-L100-Z02-H	●	25	2	25	100	35	16				
AEM90-AP16-D25-W25-L150-Z02	●	25	2	25	150	50	16				
AEM90-AP16-D25-C25-L250-Z02	●	25	2	25	250	100	16				
AEM90-AP16-D28-W25-L100-Z03-H	●	28	3	25	100	40	16				
AEM90-AP16-D28-W25-L150-Z03	●	28	3	25	150	40	16				
AEM90-AP16-D30-W25-L110-Z03-H	●	30	3	25	110	40	16				
AEM90-AP16-D30-W25-L150-Z02	●	30	2	25	150	40	16				
AEM90-AP16-D30-W25-L150-Z03	●	30	3	25	150	40	16				
new AEM90-AP16-D32-C25-L110-Z03-H	●	32	3	25	110	40	16				
AEM90-AP16-D32-W32-L110-Z03-H	●	32	3	32	110	40	16				
AEM90-AP16-D32-C32-L150-Z03	●	32	3	32	150	50	16				
AEM90-AP16-D32-W25-L150-Z03	●	32	3	25	150	40	16				
AEM90-AP16-D32-W32-L150-Z03	●	32	3	32	150	50	16				
AEM90-AP16-D32-W32-L150-Z03-H	●	32	3	32	150	50	16				
AEM90-AP16-D32-C25-L200-Z03-H	●	32	3	25	200	40	16				
AEM90-AP16-D32-C32-L250-Z02	●	32	2	32	250	100	16				
AEM90-AP16-D32-C32-L250-Z03	●	32	3	32	250	100	16				
AEM90-AP16-D35-W32-L150-Z03	●	35	3	32	150	40	16				
AEM90-AP16-D36-W32-L110-Z03-H	●	36	3	32	110	40	16				
AEM90-AP16-D36-W32-L150-Z03	●	36	3	32	150	40	16				
AEM90-AP16-D40-W32-L110-Z04-H	●	40	4	32	110	40	16				
AEM90-AP16-D40-C32-L150-Z04	●	40	4	32	150	40	16				
AEM90-AP16-D40-W32-L150-Z04	●	40	4	32	150	40	16				
AEM90-AP16-D40-C32-L250-Z02	●	40	2	32	250	40	16				
AEM90-AP16-D40-C32-L250-Z04	●	40	4	32	250	40	16				

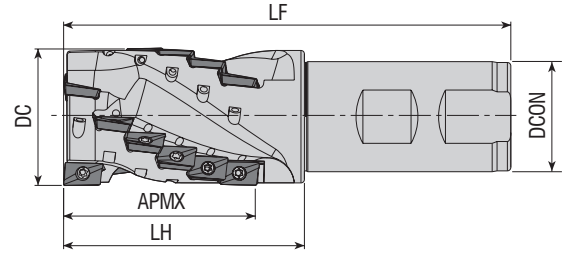
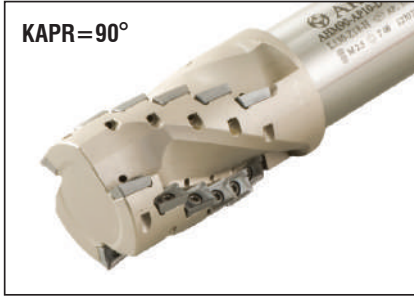

Takım Kodu Ordering Code Bestell-Bezeichnung	Stok Stock Lager	Takım Ölçüleri (mm) Dimension (mm) Abmessung (mm)							Kesici Uç Insert Wendeschneidplatte	Yedek Parçaları / Spare Parts / Ersatzteile	
		ZEPF		DC	DCON	APMX	LH	LF		Sıkma Vidası Screw Schraube	Tork Anahtar Torx Key Torx-Schlüssel
		Toplam Total Gesamt	Etkili Effective Effektiv								
AHM90-AP10-D20-W20-L087-Z0204	●	4	2	20	20	28	37	87	AP. 1003..	3008-M2.5x6	82-T08
AHM90-AP10-D20-W20-L087-Z0206	●	6	2	20	20	28	37	87			
AHM90-AP10-D25-W25-L105-Z0208-H	●	8	2	25	25	37	50	105			
AHM90-AP10-D32-W32-L115-Z0315-H	●	15	3	32	32	46	55	115			
AHM90-AP10-D40-W32-L130-Z0318-H	●	18	3	40	32	55	70	130			

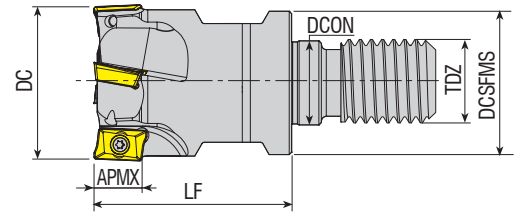
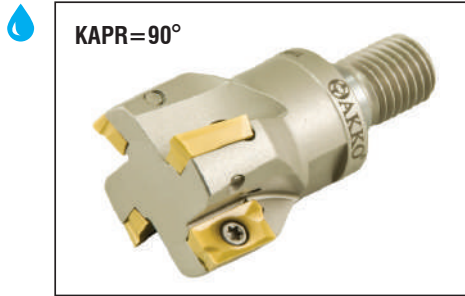

Takım Kodu Ordering Code Bestell-Bezeichnung	Stok Stock Lager	Takım Ölçüleri (mm) Dimension (mm) Abmessung (mm)							Kesici Uç Insert Wendeschneidplatte	Yedek Parçaları / Spare Parts / Ersatzteile	
		DC	ZEPF	DCSFMS	TDZ	LF	DCON	APMX		Sıkma Vidası Screw Schraube	Tork Anahtar Torx Key Torx-Schlüssel
AEM90-AP10-D16-M08-L30-Z02-H	●	16	2	14.75	M08	30	8.5	10	AP. 1003..	3008-M2.5x6	82-T08
AEM90-AP10-D20-M10-L30-Z03-H	●	20	3	18	M10	30	10.5	10			
AEM90-AP10-D25-M12-L35-Z03-H	●	25	3	21	M12	35	12.5	10			
AEM90-AP10-D32-M16-L35-Z04-H	●	32	4	29	M16	35	17	10			
AEM90-AP10-D32-M16-L40-Z04-H	●	32	4	29	M16	40	17	10			
AEM90-AP10-D40-M16-L43-Z05-H	●	40	5	29	M16	43	17	10			
AEM90-AP10-D42-M16-L43-Z05-H	●	42	5	29	M16	43	17	10			
AEM90-AP16-D25-M12-L43-Z02-H	●	25	2	21	M12	43	12.5	16	AP. 1604..	4015-M4x9	80-T15
AEM90-AP16-D32-M16-L43-Z03-H	●	32	3	29	M16	43	17	16			
AEM90-AP16-D40-M16-L43-Z04-H	●	40	4	29	M16	43	17	16			
AEM90-AP16-D42-M16-L43-Z04-H	●	42	4	29	M16	43	17	16			

R: Sağ / Right / Rechts L: Sol / Left / Links

● Stokta / In Stock / Auf Lager ○ Stokta Yok / Non Stock Item / Kein Lagerartikel, Lieferzeit auf Anfrage

ISO Ucuna Uygundur. / Compatible with ISO Insert. / Kompatibel mit ISO Wendeplatten.

Sipariş Örneği/Ordering Example/Bestellbeispiel

1 ad./pcs./stück AHM90-AP10-D20-W20-L087-Z0204

Kesme Hesabı : S 429/ Cutting Calculation : P 429 / Schnittberechnung : P 429

Sıkma Tork Değeri : S 428 / Tightening Torque : P 428 / Anzugsmoment : P 428

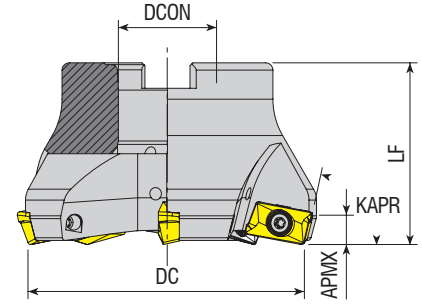

Takım Kodu Ordering Code Bestell-Bezeichnung	Stok Stock Lager	Takım Ölçüleri (mm) Dimension (mm) Abmessung (mm)					Kesici Uç Insert Wendeschneidplatte	Yedek Parçaları / Spare Parts / Ersatzteile			
		DC	ZEFP	DCON	LF	APMX		Sıkma Vidası Screw Schraube	Tork Anahtar Torx Key Torx-Schlüssel	Montaj Vidası Mounting Screw Befestigungsschraube	
AFM75-AP16-D063-A22-Z04-H	●	63	4	22	40	6	AP. 1604..	4015-M4x11	80-T15	2508-M10x30 2510-M12x35 2514-M16x35	
AFM75-AP16-D080-A27-Z05-H	●	80	5	27	50	6					
AFM75-AP16-D100-A32-Z06-H	●	100	6	32	50	6					
AFM75-AP16-D125-B40-Z07	●	125	7	40	63	6					

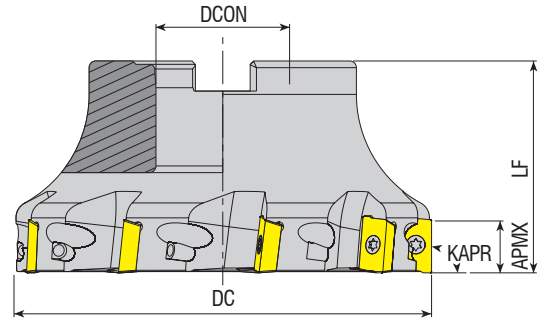

Takım Kodu Ordering Code Bestell-Bezeichnung	Stok Stock Lager	Takım Ölçüleri (mm) Dimension (mm) Abmessung (mm)					Kesici Uç Insert Wendeschneidplatte	Yedek Parçaları / Spare Parts / Ersatzteile			
		DC	ZEFP	DCON	LF	APMX		Sıkma Vidası Screw Schraube	Tork Anahtar Torx Key Torx-Schlüssel	Montaj Vidası Mounting Screw Befestigungsschraube	
AFM90-AP10-D040-A16-Z04-H	●	40	4	16	35	10	AP. 1003..	3008-M2.5x6	82-T08	2506-M8x30 2508-M10x30 2508-M10x30 2508-M10x30 2508-M10x30 2510-M12x35 2514-M16x35	
AFM90-AP10-D040-A16-Z05-H	●	40	5	16	40	10					
AFM90-AP10-D050-A22-Z06-H	●	50	6	22	40	10					
AFM90-AP10-D050-A22-Z07-H	●	50	7	22	40	10					
AFM90-AP10-D063-A22-Z06	●	63	6	22	40	10					
AFM90-AP10-D063-A22-Z07-H	●	63	7	22	40	10					
AFM90-AP10-D063-A22-Z09	●	63	9	22	40	10					
AFM90-AP10-D080-A27-Z08-H	●	80	8	27	50	10					
AFM90-AP10-D100-A32-Z09-H	●	100	9	32	50	10					
AFM90-AP16-D040-A16-Z04-H	●	40	4	16	40	16	AP. 1604..	4015-M4x11	80-T15	2506-M8x30 2508-M10x30 2510-M12x35 2514-M16x35	
AFM90-AP16-D050-A22-Z05-H	●	50	5	22	40	16					
AFM90-AP16-D052-A22-Z05-H	●	52	5	22	40	16					
AFM90-AP16-D063-A22-Z06-H	●	63	6	22	40	16					
AFM90-AP16-D080-A27-Z07-H	●	80	7	27	50	16					
AFM90-AP16-D100-A32-Z08-H	●	100	8	32	50	16					
AFM90-AP16-D125-B40-Z09	●	125	9	40	63	16					
AFM90-AP16-D160-C40-Z10	●	160	10	40	63	16					
AFM90-AP16-D200-C60-Z12	●	200	12	60	63	16					

R: Sağ / Right / Rechts/ L: Sol / Left / Links

● Stokta / In Stock / Auf Lager ○ Stokta Yok / Non Stock Item / Kein Lagerartikel, Lieferzeit auf Anfrage

ISO Ucuna Uygundur. / Compatible with ISO Insert. / Kompatibel mit ISO Wendeplatten.

Sipariş Örneği/Ordering Example/Bestellbeispiel

1 ad./pcs./stück AFM75-AP16-D063-A22-Z04-H

Kesme Hesabı : S 429/ Cutting Calculation : P 429 / Schnittberechnung : P 429

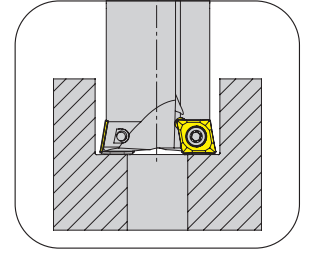
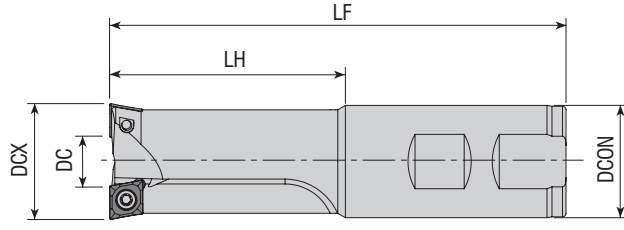

Takım Kodu Ordering Code Bestell-Bezeichnung	Stok Stock Lager	Takım Ölçüleri (mm) Dimension (mm) Abmessung (mm)					Kesici Uç Insert Wendeschneidplatte	Yedek Parçaları / Spare Parts / Ersatzteile		
		DC	DCX	DCON	LH	LF		Kullanılan Vidalar For Screws Für Schraube	Sıkma Vidası Screw Schraube	Tork Anahtar Torx Key Torx-Schlüssel
ACBM-CC06-D17X6-W16-L150-Z02	●	6	17	16	30	150	-	CC.. 060204	3008-M2.5x6	82-T08
ACBM-CC06-D18X7-W16-L100-Z02-H	●	7	18	16	32	100	M10			
ACBM-CC06-D18X7-W16-L160-Z02-H	●	7	18	16	32	160	M10			
ACBM-CC06-D20X9-W20-L100-Z02-H	●	9	20	20	40	100	M12			
ACBM-CC06-D20X9-W20-L160-Z02-H	●	9	20	20	38	160	M12	CC.. 09T304	4015-M3.5x9	80-T15
ACBM-CC09-D26X8.5-W25-L130-Z02-H	●	8.5	26	25	50	130	M16			
ACBM-CC09-D26X8.5-W25-L200-Z02-H	●	8.5	26	25	50	200	M16			
ACBM-CC09-D30X12.5-W32-L130-Z02-H	●	12.5	30	32	65	130	-			
ACBM-CC09-D33X15.5-W32-L130-Z02-H	●	15.5	33	32	65	130	M20	SP. 060204	3007-M2.2x4.6	82-T07
ACBM-CC09-D33X15.5-W32-L200-Z02-H	●	15.5	33	32	65	200	M20			
ACBM-SP06-D15X4-W16-L160-Z02-H	●	4	15	16	80	160	M8			

R: Sağ / Right / Rechts/ L: Sol / Left / Links

● Stokta / In Stock / Auf Lager ○ Stokta Yok / Non Stock Item / Kein Lagerartikel, Lieferzeit auf Anfrage

ISO Ucuna Uygundur. / Compatible with ISO Insert. / Kompatibel mit ISO Wendeplatten.

Sipariş Örneği/Ordering Example/Bestellbeispiel

1 ad./pcs./stück ACBM-CC06-D17X6-W16-L150-Z02

Kesme Hesabı : S 429/ Cutting Calculation : P 429/ Schnittberechnung : P 429



KAPR=90°

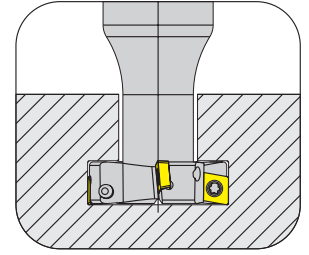
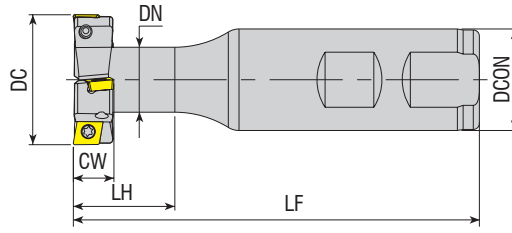

Takım Kodu
Ordering Code
Bestell-Bezeichnung

Stok
Stock
Lager

ZEPF
Toplam
Total
Gesamt

Etkili
Effective
Effektiv

DC

CW

DCON

LF

DN

LH

Takım Ölçüleri (mm)
Dimension (mm)
Abmessung (mm)

Kesici Uç
Insert
Wendeschneidplatte

Yedek Parçaları / Spare Parts / Ersatzteile

Sıkma Vidası
Screw
Schraube

Tork Anahtar
Torx Key
Torx-Schlüssel

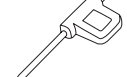

ATSM90-CC06-D17X8-W16-L85-Z02	●	2	1	17	8	16	85	10	16	CC.T 0602..	3008-M2.5x6	82-T08
ATSM90-CC06-D22X8-W20-L83-Z04	●	4	2	22	8	20	83	9	38			
ATSM90-CC06-D32X8-W25-L100-Z04	●	4	2	32	8	25	100	16	23			
ATSM90-CC06-D28X8-W20-L66-Z04	●	4	2	28	8	20	66	14	15.5			
ATSM90-CC06-D45.5X8-W25-L100-Z06	●	6	3	45.5	8	25	100	12	30			
ATSM90-CC06-D63X8-W32-L125-Z08	●	8	4	63	8	32	125	31.5	30			
ATSM90-CC06-D18X9-W16-L90-Z02	●	2	1	18	9	16	90	10	16			
ATSM90-CC06-D20X9-W16-L85-Z04	●	4	2	20	9	16	85	10	16			
ATSM90-CC06-D23X10-W20-L90-Z04	●	4	2	23	10	20	90	12	25			
ATSM90-CC06-D32X10-W25-L100-Z04	●	4	2	32	10	25	100	16	25			
ATSM90-CC06-D45X10-W32-L120-Z06	●	6	3	45	10	32	120	20	25			
ATSM90-CC06-D25X11-W25-L100-Z04	●	4	2	25	11	25	100	13	25			
ATSM90-CC09-D30X12-W25-L100-Z04	●	4	2	30	12	25	100	16	25			
ATSM90-CC09-D32X12-W25-L100-Z02	●	2	1	32	12	25	100	16	25			
ATSM90-CC09-D32X12-W25-L100-Z04	●	4	2	32	12	25	100	16	25			
ATSM90-CC09-D32X14-W25-L100-Z04	●	4	2	32	14	25	100	16	25			
ATSM90-CC09-D37X16-W32-L120-Z04	●	4	2	37	16	32	120	17	30			
ATSM90-CC09-D40X17-W32-L120-Z04-H	●	4	2	40	17	32	120	19	30			
ATSM90-CC09-D42X17-W32-L120-Z04	●	4	2	42	17	32	120	19	30			
ATSM90-CC12-D47X20-W32-L120-Z04	●	4	2	47	20	32	120	25	45			
ATSM90-CC12-D52X21-W32-L120-Z04	●	4	2	52	21	32	120	25	45			
ATSM90-CC12-D50X22-W32-L120-Z04	●	4	2	50	22	32	120	25	45			
ATSM90-CC12-D55X22-W32-L120-Z04	●	4	2	55	22	32	120	25	45			

CC.T 09T3..

4015-M3.5x9

80-T15

CC.T 1204..

1020-M5x11

80-T20

R: Sağ / Right / Rechts L: Sol / Left / Links

● Stokta / In Stock / Auf Lager ○ Stokta Yok / Non Stock Item / Kein Lagerartikel, Lieferzeit auf Anfrage

ISO Ucuna Uygundur. / Compatible with ISO Insert. / Kompatibel mit ISO Wendeplatten.

Sipariş Örneği/Ordering Example/Bestellbeispiel

1 ad./pcs./stück ATSM90-CC06-D17X8-W16-L85-Z02

Kesme Hesabı : S 429 / Cutting Calculation : P 429 / Schnittberechnung : P 429



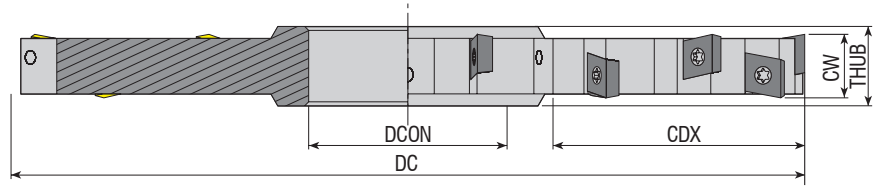

Takım Kodu
Ordering Code
Bestell-Bezeichnung

Takım Kodu Ordering Code Bestell-Bezeichnung	Stok Stock Lager	ZEPF		Takım Ölçüleri (mm) Dimension (mm) Abmessung (mm)				Kesici Uç Insert Wendeschneidplatte	Yedek Parçaları / Spare Parts / Ersatzteile		
		Toplam Total Gesamt	Etkili Effective Effektiv	DC	CW	CDX	DCON		THUB	Sıkma Vidası Screw Schraube	Tork Anahtar Torx Key Torx-Schlüssel
ASDM-CC06-D80x8-d27-Z10	●	10	5	80	8	17	27	12	CC.T 0602..	3008-M2.5x6	82-T08
ASDM-CC06-D100x8-d32-Z12	●	12	6	100	8	25	32	12			
ASDM-CC06-D125x8-d40-Z14	●	14	7	125	8	35	40	12			
ASDM-CC06-D160x8-d40-Z16	●	16	8	160	8	52	40	12			
ASDM-CC06-D200x8-d40-Z18	●	18	9	200	8	70	40	12			
ASDM-CC06-D80x10-d27-Z10	●	10	5	80	10	17	27	14			
ASDM-CC06-D100x10-d32-Z12	●	12	6	100	10	25	32	14			
ASDM-CC06-D125x10-d40-Z14	●	14	7	125	10	35	40	14			
ASDM-CC06-D160x10-d40-Z16	●	16	8	160	10	52	40	14			
ASDM-CC06-D200x10-d40-Z18	●	18	9	200	10	70	40	14			
ASDM-CC09-D80x12-d27-Z08	●	8	4	80	12	17	27	16	CC.T 09T3..	4015-M3.5x11	80-T15
ASDM-CC09-D100x12-d32-Z10	●	10	5	100	12	25	32	16			
ASDM-CC09-D125x12-d40-Z12	●	12	6	125	12	35	40	16			
ASDM-CC09-D160x12-d40-Z14	●	14	7	160	12	52	40	16			
ASDM-CC09-D200x12-d40-Z16	●	16	8	200	12	70	40	16			
ASDM-CC09-D80x14-d27-Z08	●	8	4	80	14	17	27	18			
ASDM-CC09-D100x14-d32-Z10	●	10	5	100	14	25	32	18			
ASDM-CC09-D125x14-d40-Z12	●	12	6	125	14	35	40	18			
ASDM-CC09-D160x14-d40-Z14	●	14	7	160	14	52	40	18			
ASDM-CC09-D200x14-d40-Z16	●	16	8	200	14	70	40	18			
ASDM-CC12-D80x16-d27-Z06	●	6	3	80	16	17	27	20	CC.T 1204..	1020-M5x11	80-T20
ASDM-CC12-D100x16-d32-Z08	●	8	4	100	16	25	32	20			
ASDM-CC12-D125x16-d40-Z10	●	10	5	125	16	35	40	20			
ASDM-CC12-D160x16-d40-Z12	●	12	6	160	16	52	40	20			
ASDM-CC12-D200x16-d40-Z14	●	14	7	200	16	70	40	20			
ASDM-CC12-D80x18-d27-Z06	●	6	3	80	18	17	27	22			
ASDM-CC12-D100x18-d32-Z08	●	8	4	100	18	25	32	22			
ASDM-CC12-D125x18-d40-Z10	●	10	5	125	18	35	40	22			
ASDM-CC12-D160x18-d40-Z12	●	12	6	160	18	52	40	22			
ASDM-CC12-D200x18-d40-Z14	●	14	7	200	18	70	40	22			
ASDM-CC12-D250x18-d40-Z16	●	16	8	250	18	90	40	22			
ASDM-CC12-D80x20-d27-Z06	●	6	3	80	20	17	27	24			
ASDM-CC12-D100x20-d32-Z08	●	8	4	100	20	25	32	24			
ASDM-CC12-D125x20-d40-Z10	●	10	5	125	20	35	40	24			
ASDM-CC12-D160x20-d40-Z12	●	12	6	160	20	52	40	24			
ASDM-CC12-D200x20-d40-Z14	●	14	7	200	20	70	40	24			
ASDM-CC12-D250x20-d40-Z16	●	16	8	250	20	90	40	24			

R: Sağ / Right / Rechts L: Sol / Left / Links

● Stokta / In Stock / Auf Lager ○ Stokta Yok / Non Stock Item / Kein Lagerartikel, Lieferzeit auf Anfrage

ISO Ucuna Uygundur. / Compatible with ISO Insert. / Kompatibel mit ISO Wendeplatten.

Sipariş Örneği/Ordering Example/Bestellbeispiel

1 ad./pcs./stück ASDM-CC06-D80x8-d27-Z10

Kesme Hesabı : S 429 / Cutting Calculation : P 429 / Schnittberechnung : P 429

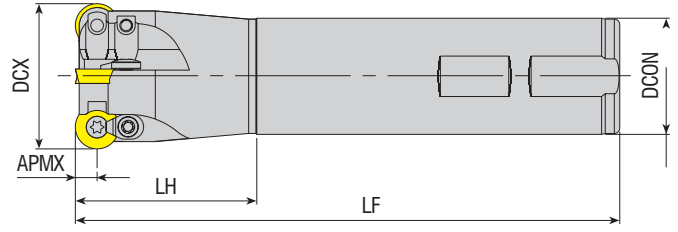

Takım Kodu Ordering Code Bestell-Bezeichnung	Stok Stock Lager	Takım Ölçüleri (mm) Dimension (mm) Abmessung (mm)						Kesici Uç Insert Wendeschneidplatte	Yedek Parçaları / Spare Parts / Ersatzteile								
		DCX	ZEFP	DCON	LF	LH	APMX		Sıkma Vidası Screw Schraube	Baskı Parçası Wedge Clamp Spannpratze	Baskı Vidası Clamp Screw Schraube	Tork Anahtar Torx Key Torx-Schlüssel					
AEMR-RD0501-D08-W10-L100-Z01-H	●	8	1	10	100	20	2.5	RD.. 0501	3006-M2x3.6				82-T06				
AEMR-RD0501-D10-W12-L100-Z02-H	●	10	2	12	100	20	2.5										
AEMR-RD0501-D12-W12-L120-Z02-H	●	12	2	12	120	20	2.5										
AEMR-RD0803-D16-W16-L150-Z02	●	16	2	16	150	60	4	RD.. 0803	3008-M3x6	-	-	82-T08					
AEMR-RD0803-D16-C20-L200-Z02	●	16	2	20	200	60	4										
AEMR-RD0803-D20-W20-L150-Z03	●	20	3	20	150	60	4	RD.. 08T2	3008-M2.5x6								
AEMR-RD08T2-D16-W16-L150-Z02	●	16	2	16	150	60	4										
AEMR-RD08T2-D20-W20-L150-Z02	●	20	2	20	150	60	4	RD.. 1003									
AEMRC-RD1003-D20-W20-L150-Z02	●	20	2	20	150	60	5										
AEMRC-RD1003-D20-C20-L160-Z02	●	20	2	20	160	70	5										
AEMRC-RD1003-D20-C20-L250-Z02	●	20	2	20	250	150	5										
AEMRC-RD1003-D21-C20-L160-Z02	●	21	2	20	160	70	5										
AEMRC-RD1003-D25-W25-L150-Z02	●	25	2	25	150	60	5										
AEMRC-RD1003-D25-C25-L160-Z02	●	25	2	25	160	70	5										
AEMRC-RD1003-D25-W25-L200-Z02	●	25	2	25	200	100	5										
AEMRC-RD1003-D25-C25-L200-Z02	●	25	2	25	200	100	5										
AEMRC-RD1003-D25-C25-L250-Z02	●	25	2	25	250	150	5										
AEMRC-RD1003-D26-C25-L160-Z02	●	26	2	25	160	70	5										
AEMRC-RD1003-D32-W32-L150-Z03	●	32	3	32	150	60	5										
AEMRC-RD1003-D32-C32-L250-Z02	●	32	2	32	250	150	5										
AEMRC-RD1003-D33-C32-L160-Z03	●	33	3	32	160	70	5										
AEMRC-RD1003-D40-W32-L150-Z04	●	40	4	32	150	35	5										
AEMRC-RD1003-D40-C32-L250-Z02	●	40	2	32	250	50	5										
AEMR-RD10T3-D20-C20-L180-Z02-H	●	20	2	20	180	60	5						RD.. 10T3	4015-M3.5x9	ACK-15	4015-M3.5x11	80-T15
AEMRC-RD10T3-D20-C20-L150-Z02	●	20	2	20	150	60	5										
AEMRC-RD10T3-D20-W20-L150-Z02	●	20	2	20	150	60	5										
AEMRC-RD10T3-D21-C20-L200-Z02-H	●	21	2	20	200	80	5										
AEMRC-RD10T3-D25-C25-L150-Z02	●	25	2	25	150	60	5										
AEMR-RD10T3-D25-C25-L180-Z02	●	25	2	25	180	80	5										
AEMRC-RD10T3-D25-C25-L200-Z02-H	●	25	2	25	200	100	5										
AEMRC-RD10T3-D25-C32-L150-Z03	●	25	3	32	150	50	5										
AEMRC-RD10T3-D25-W25-L150-Z02	●	25	2	25	150	60	5										
AEMRC-RD10T3-D26-C25-L200-Z02-H	●	26	2	25	200	35	5										
AEMRC-RD10T3-D32-C25-L250-Z03-H	●	32	3	25	250	35	5										
AEMRC-RD10T3-D32-W32-L150-Z03	●	32	3	32	150	60	5										
AEMRC-RD10T3-D32-C32-L150-Z04	●	32	4	32	150	60	5	RD.. 12T3									
AEMRC-RD12T3-D25-W25-L150-Z02	●	25	2	25	150	60	6										
AEMRC-RD12T3-D25-W25-L200-Z02	●	25	2	25	200	100	6										
AEMRC-RD12T3-D25-C25-L250-Z02	●	25	2	25	250	150	6										
AEMRC-RD12T3-D25-C25-L300-Z02	●	25	2	25	300	200	6										
AEMRC-RD12T3-D32-W32-L150-Z03	●	32	3	32	150	60	6										
AEMRC-RD12T3-D32-C32-L250-Z02	●	32	2	32	250	150	6										
AEMRC-RD12T3-D40-W32-L150-Z04	●	40	4	32	150	50	6						RD.. 1204				
AEMRC-RD12T3-D40-C32-L250-Z02	●	40	2	32	250	50	6										
AEMR-RD1204-D25-C25-L180-Z02	●	25	2	25	180	70	6										
AEMRC-RD1204-D32-C32-L200-Z02	●	32	2	32	200	100	6										
AEMRC-RD1204-D32-C32-L160-Z03	●	32	3	32	160	70	6	RD.. 1604	4015-M4.5x11	ACK-05	4015-M4x11						
AEMRC-RD1204-D32-W32-L160-Z03	●	32	3	32	160	70	6										
AEMRC-RD1204-D33-C32-L160-Z03	●	33	3	32	160	70	6										
AEMRC-RD1204-D32-C32-L160-Z03-H	●	32	3	32	160	70	6										
AEMRC-RD1604-D40-W32-L150-Z02	●	40	2	32	150	35	8										

R: Sağ / Right / Rechts L: Sol / Left / Links

● Stokta / In Stock / Auf Lager ○ Stokta Yok / Non Stock Item / Kein Lagerartikel, Lieferzeit auf Anfrage

ISO Ucuna Uygundur. / Compatible with ISO Insert. / Kompatibel mit ISO Wendeplatten.

Sipariş Örneği/Ordering Example/Bestellbeispiel

1 ad./pcs./stück AEMR-RD0501-D08-W10-L100-Z01-H

Kesme Hesabı : S 429/ Cutting Calculation : P 429 / Schnittberechnung : P 429

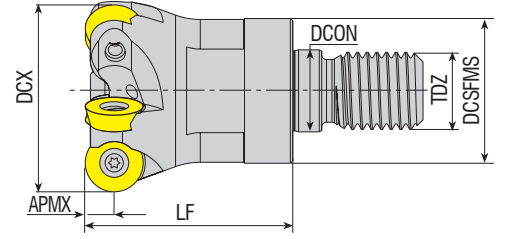

Takım Kodu Ordering Code Bestell-Bezeichnung	Stok Stock Lager	Takım Ölçüleri (mm) Dimension (mm) Abmessung (mm)							Kesici Uç Insert Wendeschneidplatte	Yedek Parçaları / Spare Parts / Ersatzteile	
		DCX	ZEFP	DCSFMS	TDZ	LF	DCON	APMX		Sıkma Vidası Screw Schraube	Tork Anahtar Torx Key Torx-Schlüssel
AEMR-RD0702-D15-M08-L23-Z02-H	●	15	2	13	M08	23	8.5	3.5	RD.. 0702	3008-M2.5x6	
AEMR-RD0702-D16-M08-L23-Z02-H	●	16	2	14.75	M08	23	8.5	3.5			
AEMR-RD0702-D20-M10-L30-Z04-H	●	20	4	18	M10	30	10.5	3.5			
AEMR-RD0702-D25-M12-L35-Z05-H	●	25	5	21	M12	35	12.5	3.5			
AEMR-RD0702-D30-M16-L42-Z05-H	●	30	5	29	M16	42	17	3.5			
AEMR-RD0702-D32-M16-L43-Z05-H	●	32	5	29	M16	43	17	3.5			
AEMR-RD0702-D35-M16-L42-Z06-H	●	35	6	29	M16	42	17	3.5			
AEMR-RD0702-D42-M16-L43-Z05-H	●	42	5	29	M16	43	17	3.5			
AEMR-RD0702-D42-M16-L43-Z07-H	●	42	7	29	M16	43	17	3.5	RD.. 08T2	3008-M2.5x6	82-T08
AEMR-RD08T2-D16-M08-L23-Z02-H	●	16	2	13	M08	23	8.5	4			
AEMR-RD08T2-D16-M10-L23-Z02-H	●	16	2	13	M10	23	8.5	4			
AEMR-RD08T2-D20-M10-L30-Z03-H	●	20	3	18	M10	30	10.5	4			
AEMR-RD08T2-D25-M12-L35-Z04-H	●	25	4	21	M12	35	12.5	4			
AEMR-RD0802-D16-M08-L23-Z02-H	●	16	2	13	M08	23	8.5	4			
AEMR-RD0803-D16-M08-L23-Z02-H	●	16	2	13	M08	23	8.5	4			
AEMR-RD0803-D20-M10-L30-Z03-H	●	20	3	18	M10	30	10.5	4			
AEMR-RD0803-D25-M12-L35-Z04-H	●	25	4	21	M12	35	12.5	4	RD.. 1003	3008-M3x6	3008-M3x8
AEMR-RD1003-D20-M10-L30-Z02-H	●	20	2	18	M10	30	10.5	5			
AEMR-RD1003-D25-M12-L35-Z02-H	●	25	2	21	M12	35	12.5	5			
AEMR-RD1003-D25-M12-L35-Z03-H	●	25	3	21	M12	35	12.5	5			
AEMR-RD1003-D30-M16-L43-Z04-H	●	30	4	29	M16	43	17	5			
AEMR-RD1003-D32-M16-L43-Z04-H	●	32	4	29	M16	43	17	5			
AEMR-RD1003-D35-M16-L43-Z04-H	●	35	4	29	M16	43	17	5			
AEMR-RD1003-D40-M16-L43-Z05-H	●	40	5	29	M16	43	17	5			
AEMR-RD1003-D42-M16-L43-Z05-H	●	42	5	29	M16	43	17	5	RD.. 10T3	4015-M3.5x9	
AEMR-RD10T3-D25-M12-L35-Z03-H	●	25	3	21	M12	35	12.5	5			
AEMR-RD10T3-D32-M16-L45-Z04-H	●	32	4	29	M16	45	17	5			
AEMR-RD10T3-D35-M16-L43-Z04-H	●	35	4	29	M16	43	17	5			
AEMR-RD10T3-D42-M16-L43-Z05-H	●	42	5	29	M16	43	17	5			
AEMR-RD1004-D25-M12-L35-Z03-H	●	25	3	21	M12	35	12.5	5			
AEMR-RD1004-D32-M16-L43-Z04-H	●	32	4	29	M16	43	17	5			
AEMR-RD1004-D42-M16-L43-Z05-H	●	42	5	29	M16	43	17	5			
AEMR-RD12T3-D24-M12-L35-Z02-H	●	24	2	21	M12	35	12.5	6	RD.. 12T3	4015-M3.5x9	
AEMR-RD12T3-D25-M12-L35-Z02-H	●	25	2	21	M12	35	12.5	6			
AEMR-RD12T3-D32-M16-L43-Z03-H	●	32	3	29	M16	43	17	6			
AEMR-RD12T3-D35-M16-L43-Z03-H	●	35	3	29	M16	43	17	6			
AEMR-RD12T3-D35-M16-L43-Z04-H	●	35	4	29	M16	43	17	6			
AEMR-RD12T3-D40-M16-L43-Z04-H	●	40	4	29	M16	43	17	6			
AEMR-RD12T3-D42-M16-L43-Z05-H	●	42	5	29	M16	43	17	6			
AEMR-RD1204-D25-M12-L35-Z02-H	●	25	2	21	M12	35	12.5	6			
AEMR-RD1204-D32-M16-L43-Z03-H	●	32	3	29	M16	43	17	6	RD.. 1204	4015-M3.5x9	
AEMR-RD1204-D40-M16-L43-Z04-H	●	40	4	29	M16	43	17	6			
AEMR-RD1204-D42-M16-L43-Z04-H	●	42	4	29	M16	43	17	6			
AEMR-RD1604-D32-M16-L43-Z02-H	●	32	2	29	M16	43	17	8			
AEMR-RD1604-D40-M16-L43-Z02-H	●	40	2	29	M16	43	17	8	RD.. 1604	4015-M4.5x11	
AEMR-RD1604-D42-M16-L43-Z03-H	●	42	3	29	M16	43	17	8			

R: Sağ / Right / Rechts/ L: Sol / Left / Links

● Stokta / In Stock / Auf Lager ○ Stokta Yok / Non Stock Item / Kein Lagerartikel, Lieferzeit auf Anfrage

ISO Ucuna Uygundur. / Compatible with ISO Insert. / Kompatibel mit ISO Wendeplatten.

Sipariş Örneği/Ordering Example/Bestellbeispiel

1 ad./pcs./stück AEMR-RD0702-D15-M08-L23-Z02-H

Kesme Hesabı : S 429/ Cutting Calculation : P 429 / Schnittberechnung : P 429

Sıkma Tork Değeri : S 428 / Tightening Torque : P 428 / Anzugsmoment : P 428

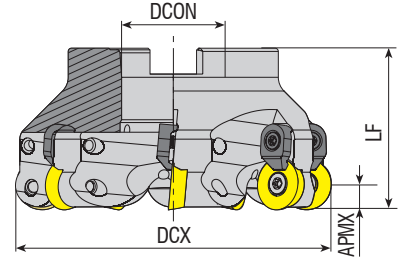

Takım Kodu Ordering Code Bestell-Bezeichnung	Stok Stock Lager	Takım Ölçüleri (mm) Dimension (mm) Abmessung (mm)					Kesici Uç Insert Wendeschneidplatte	Yedek Parçaları / Spare Parts / Ersatzteile									
		DCX	ZEPF	DCON	LF	APMX		Sıkma Vidası Screw Schraube	Baskı Parçası Wedge Clamp Spannpratze	Baskı Vidası Clamp Screw Klemmschraube	Tork Anahtar Torx Key Torx-Schlüssel	Montaj Vidası Mounting Screw Befestigungsschraube					
AFMR-RD0702-D050-A22-Z06-H	●	50	6	22	40	3.5	RD.. 0702	3008-M2.5x6	-	-	82-T08	2407-M10x30					
AFMR-RD0803-D050-A22-Z05-H	●	50	5	22	40	4	RD.. 0803	3008-M3x8	-	-	82-T08	2407-M10x30					
AFMRC-RD1003-D040-A16-Z04-H	●	40	4	16	40	5	RD.. 1003	4015-M3.5x11	-	-	82-T08	2406-M8x30					
AFMR-RD1003-D040-A16-Z05-H	●	40	5	16	40	5						2508-M10x30					
AFMRC-RD1003-D050-A22-Z05-H	●	50	5	22	50	5						2510-M12X35					
AFMRC-RD1003-D052-A22-Z05	●	52	5	22	50	5						2514-M16x35					
AFMRC-RD1003-D063-A22-Z06-H	●	63	6	22	50	5						2406-M8X30					
AFMRC-RD1003-D066-A27-Z07-H	●	66	7	27	50	5						4515-M4x8					
AFMRC-RD1003-D080-A27-Z07-H	●	80	7	27	50	5						2406-M8X30					
AFMRC-RD1003-D100-A32-Z08-H	●	100	8	32	50	5						4515-M4x8					
AFMR-RD1004-D063-A22-Z06-H	●	63	6	22	50	5						RD.. 1004	4515-M4x8	-	-	82-T08	2407-M10x30
AFMRC-RD1004-D080-A27-Z08-H	●	80	8	27	50	5						RD.. 1004	4515-M4x8	-	-	82-T08	2407-M10x30
AFMRC-RD10T3-D040-A16-Z05-H	●	40	5	16	40	5	RD.. 10T3	-	-	82-T08	2406-M8X30						
AFMRC-RD10T3-D042-A16-Z05-H	●	42	5	16	40	5					2406-M8X30						
AFMRC-RD10T3-D050-A22-Z05-H	●	50	5	22	50	5					2508-M10X30						
AFMRC-RD10T3-D052-A22-Z05-H	●	52	5	22	40	5					2406-M8X30						
AFMRC-RD10T3-D052-A22-Z06-H	●	52	6	22	40	5					4015-M3.5x9						
AFMRC-RD10T3-D063-A22-Z06-H	●	63	6	22	50	5					2406-M8X30						
AFMR-RD12T3-D066-A27-Z06-H	●	66	6	22	50	50					RD.. 12T3	4015-M3.5x11	ACK-15	4015-M3.5x11	80-T15	2406-M8X30	
AFMRC-RD12T3-D040-A16-Z04-H	●	40	4	27	50	6	RD.. 12T3	4015-M3.5x11	ACK-15	4015-M3.5x11	80-T15	2406-M8X30					
AFMRC-RD12T3-D050-A22-Z05-H	●	50	5	16	40	6	RD.. 12T3	4015-M3.5x11	ACK-15	4015-M3.5x11	80-T15	2406-M8X30					
AFMRC-RD12T3-D052-A22-Z05-H	●	52	5	22	50	6	RD.. 12T3	4015-M3.5x11	ACK-15	4015-M3.5x11	80-T15	2406-M8X30					
AFMRC-RD12T3-D063-A22-Z06-H	●	63	6	22	50	6	RD.. 12T3	4015-M3.5x11	ACK-15	4015-M3.5x11	80-T15	2406-M8X30					
AFMRC-RD12T3-D080-A27-Z07-H	●	80	7	22	50	6	RD.. 12T3	4015-M3.5x11	ACK-15	4015-M3.5x11	80-T15	2406-M8X30					
AFMRC-RD12T3-D100-A32-Z08-H	●	100	8	27	50	6	RD.. 12T3	4015-M3.5x11	ACK-15	4015-M3.5x11	80-T15	2406-M8X30					
AFMRC-RD12T3-D125-B40-Z09	●	125	9	32	50	6	RD.. 12T3	4015-M3.5x11	ACK-15	4015-M3.5x11	80-T15	2406-M8X30					
AFMRC-RD1204-D040-A16-Z04-H	●	40	4	40	40	6	RD.. 1204	-	-	82-T08	2406-M8X30						
AFMRC-RD1204-D042-A16-Z04-H	●	42	4	16	40	6					2406-M8X30						
AFMRC-RD1204-D050-A22-Z05-H	●	50	5	16	40	6					2508-M10X30						
AFMRC-RD1204-D052-A22-Z05-H	●	52	5	22	50	6					4015-M3.5x11						
AFMRC-RD1204-D063-A22-Z06-H	●	63	6	22	50	6					2510-M12X35						
AFMRC-RD1204-D063-A22-Z07-H	●	63	7	22	50	6					2514-M16x35						
AFMRC-RD1204-D080-A27-Z07-H	●	80	7	22	50	6					2408-M10x30						
AFMRC-RD1204-D100-A32-Z07-H	●	100	7	27	50	6					2508-M10X30						
AFMRC-RD1204-D100-A32-Z08-H	●	100	8	32	50	6					2510-M12X35						
AFMRC-RD1204-D100-A32-Z07-H	●	100	7	27	50	6					2514-M16x35						
AFMRC-RD1604-D050-A22-Z04-H	●	50	4	32	50	6	RD.. 1604	4015-M4.5x11	ACK-05	4015-M4x11	2408-M10x30						
AFMRC-RD1604-D052-A22-Z04-H	●	52	4	22	50	8					2508-M10X30						
AFMRC-RD1604-D063-A22-Z05-H	●	63	5	22	50	8					2510-M12X35						
AFMRC-RD1604-D066-A22-Z05-H	●	66	5	22	50	8					2514-M16x35						
AFMRC-RD1604-D066-A27-Z05-H	●	66	5	22	50	8					2408-M10x30						
AFMRC-RD1604-D080-A27-Z06-H	●	80	6	27	50	8					2508-M10X30						
AFMRC-RD1604-D100-A32-Z07-H	●	100	7	27	50	8					2510-M12X35						
AFMRC-RD1604-D125-B40-Z07	●	125	7	32	50	8					2514-M16x35						
AFMRC-RD1604-D160-C40-Z08	●	160	8	40	63	8					2408-M10x30						
AFMRC-RD1604-D200-C40-Z10	●	200	10	40	63	8					2508-M10X30						

R: Sağ / Right / Rechts L: Sol / Left / Links

● Stokta / In Stock / Auf Lager ○ Stokta Yok / Non Stock Item / Kein Lagerartikel, Lieferzeit auf Anfrage

ISO Ucuna Uygundur. / Compatible with ISO Insert. / Kompatibel mit ISO Wendeplatten.

Sipariş Örneği/Ordering Example/Bestellbeispiel

1 ad./pcs./stück AFMR-RD0702-D050-A22-Z06-H

Kesme Hesabı : S 429 / Cutting Calculation : P 429 / Schnittberechnung : P 429

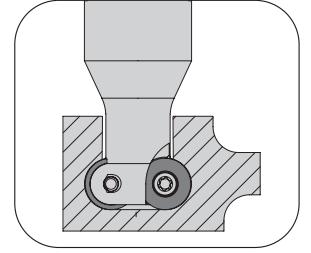
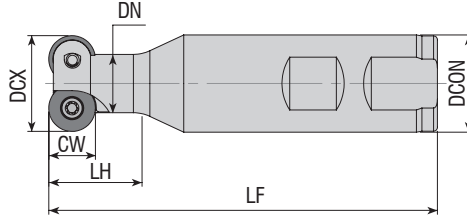

Takım Kodu Ordering Code Bestell-Bezeichnung	Stok Stock Lager	Takım Ölçüleri (mm) Dimension (mm) Abmessung (mm)							Kesici Uç Insert Wendeschneidplatte	Yedek Parçaları / Spare Parts / Ersatzteile		
		ZEFP	DCX	CW	DCON	LF	DN	LH		Sıkma Vidası Screw Schraube	Tork Anahtar Torx Key Torx-Schlüssel	
ATSMR-RD0702-D17-W16-L90-Z02	●	2	17	7	16	90	10	12	RD.. 0702	3008-M2.5x6	82-T08	
ATSMR-RD0702-D25-W16-L90-Z03	●	3	25	7	16	90	12.5	12				
ATSMR-RD0702-D35-W25-L100-Z05	●	5	35	7	25	100	20	20				
ATSMR-RD1003-D21-W25-L100-Z02	●	2	21	10	25	100	12	20	RD.. 1003	4015-M3.5x9	80-T15	
ATSMR-RD1003-D80-W32-L165-Z06-H	●	6	80	10	32	165	31.5	30				
ATSMR-RD12T3-D25-W25-L100-Z02	●	2	25	12	25	100	15	24	RD.. 12T3	4015-M3.5x9	80-T15	
ATSMR-RD12T3-D40-W32-L100-Z03	●	3	40	12	32	100	20	28				
ATSMR-RD12T3-D80-W32-L165-Z06-H	●	6	80	12	32	165	30	31.5	RD.. 1604	4015-M4.5x11		
ATSMR-RD1604-D34-W32-L110-Z02	●	2	34	16	32	110	20	30				

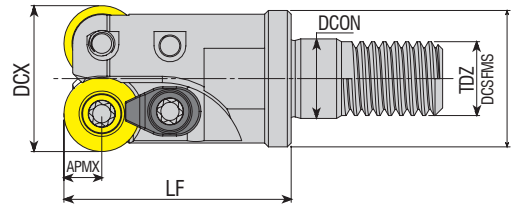

Takım Kodu Ordering Code Bestell-Bezeichnung	Stok Stock Lager	Takım Ölçüleri (mm) Dimension (mm) Abmessung (mm)							Kesici Uç Insert Wendeschneidplatte	Yedek Parçaları / Spare Parts / Ersatzteile			
		DCX	ZEFP	DCSFMS	TDZ	LF	DCON	APMX		Sıkma Vidası Screw Schraube	Baskı Parçası Wedge Clamp Spannpratze	Baskı Vidası Clamp Screw Schraube	Tork Anahtar Torx Key Torx-Schlüssel
AEMRC-RD10T3-D20-M10-L30-Z02	●	20	2	18	M10	30	10.5	5	RD.. 10T3	4015-M3.5x9	ACK-15	4015-M3.5x11	80-T15
AEMRC-RD10T3-D25-M12-L35-Z02-H	●	25	2	21	M12	35	12.5	5					
AEMRC-RD10T3-D32-M16-L43-Z03-H	●	32	3	29	M16	43	17	5					

R: Sağ / Right / Rechts/ L: Sol / Left / Links

● Stokta / In Stock / Auf Lager ○ Stokta Yok / Non Stock Item / Kein Lagerartikel, Lieferzeit auf Anfrage

ISO Ucuna Uygundur. / Compatible with ISO Insert. / Kompatibel mit ISO Wendeplatten.

Sipariş Örneği/Ordering Example/Bestellbeispiel

1 ad./pcs./stück ATSMR-RD0702-D17-W16-L90-Z02

Kesme Hesabı : S 429 / Cutting Calculation : P 429 / Schnittberechnung : P 429

Sıkma Tork Değeri : S 428 / Tightening Torque : P 428 / Anzugsmoment : P 428

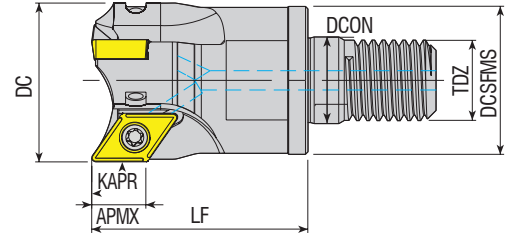

Takım Kodu Ordering Code Bestell-Bezeichnung	Stok Stock Lager	Takım Ölçüleri (mm) Dimension (mm) Abmessung (mm)							Kesici Uç Insert Wendeschneidplatte	Yedek Parçaları / Spare Parts / Ersatzteile		
		DC	ZEFP	DCSFMS	TDZ	LF	DCON	APMX		Sıkma Vidası Screw Schraube	Tork Anahtar Torx Key Torx-Schlüssel	
AEM90-DC07-D20-M10-L30-Z02-H	●	20	2	18	M10	30	10.5	7	DC.T 0702..		3008-M2.5x6	82-T08
AEM90-DC07-D25-M12-L35-Z03-H	●	25	3	21	M12	35	12.5	7				
AEM90-DC07-D32-M16-L43-Z04-H	●	32	4	29	M16	43	17	7				
AEM90-DC07-D40-M16-L43-Z05-H	●	40	5	29	M16	43	17	7				
AEM90-DC11-D32-M16-L43-Z03-H-F	●	32	3	29	M16	43	17	11	DC.T 11T3..		4015-M3.5x9	80-T15
AEM90-DC11-D40-M16-L43-Z03-H-F	●	40	3	29	M16	43	17	11				

F: Eksenel ve Radyal Salgı Değeri 0,02 mm içindedir. / F: Axial and Radial Runout Value is within 0,02 mm. / F: Der axiale und radiale Rundlaufwert liegt innerhalb von 0,02 mm.

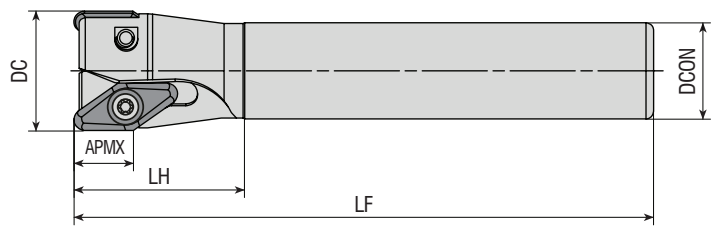

Takım Kodu Ordering Code Bestell-Bezeichnung	Stok Stock Lager	Takım Ölçüleri (mm) Dimension (mm) Abmessung (mm)							Kesici Uç Insert Wendeschneidplatte	Yedek Parçaları / Spare Parts / Ersatzteile	
		DC	ZEFP	DCON	LF	LH	APMX	Sıkma Vidası Screw Schraube		Tork Anahtar Torx Key Torx-Schlüssel	
AEM90-VC2205-D32-C25-L150-Z02-H	●	32	2	25	150	50	15	VCKT 2205..		4015-M4.5x11	80-T15
AEM90-VC2205-D40-C32-L150-Z03-H	●	40	3	32	150	50	15				

R: Sağ / Right / Rechts/ L: Sol / Left / Links

● Stokta / In Stock / Auf Lager ○ Stokta Yok / Non Stock Item / Kein Lagerartikel, Lieferzeit auf Anfrage

ISO Ucuna Uygundur. / Compatible with ISO Insert. / Kompatibel mit ISO Wendeplatten.

Sipariş Örneği/Ordering Example/Bestellbeispiel
1 ad./pcs./stück AEM90-DC07-D20-M10-L30-Z02-H

Kesme Hesabı : S 429/ Cutting Calculation : P 429 / Schnittberechnung : P 429

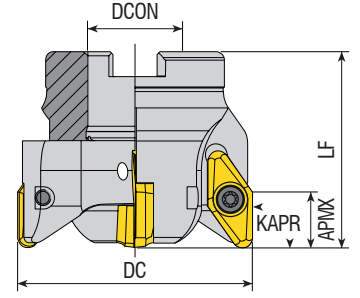
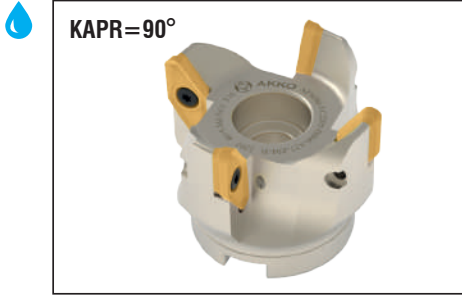

Takım Kodu Ordering Code Bestell-Bezeichnung	Stok Stock Lager	Takım Ölçüleri (mm) Dimension (mm) Abmessung (mm)					Kesici Uç Insert Wendeschneidplatte	Yedek Parçaları / Spare Parts / Ersatzteile					
		DC	ZEPF	DCON	LF	APMX		Sıkma Vidası Screw Schraube	Tork Anahtar Torx Key Torx-Schlüssel	Montaj Vidası Mounting Screw Befestigungsschraube			
AFM90-VC2205-D050-A22-Z03-H	●	50	3	22	55	15	VCKT 2205..						
AFM90-VC2205-D063-A22-Z04-H	●	63	4	22	55	15					4015-M4.5x11	80-T15	2508-M10x30
AFM90-VC2205-D066-A27-Z04-H	●	66	4	27	55	15							2510-M12x35
AFM90-VC2205-D080-A27-Z05-H	●	80	5	27	60	15							

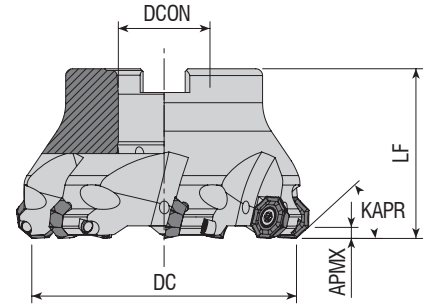
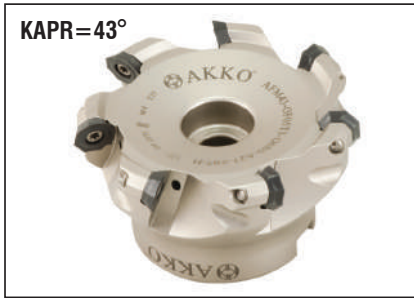

Takım Kodu Ordering Code Bestell-Bezeichnung	Stok Stock Lager	Takım Ölçüleri (mm) Dimension (mm) Abmessung (mm)					Kesici Uç Insert Wendeschneidplatte	Yedek Parçaları / Spare Parts / Ersatzteile					
		DC	ZEPF	DCON	LF	APMX		Sıkma Vidası Screw Schraube	Tork Anahtar Torx Key Torx-Schlüssel	Montaj Vidası Mounting Screw Befestigungsschraube			
AFM43-OF05T3-D050-A22-Z05-H	●	50	5	22	40	3	OF. 05T3..						
AFM43-OF05T3-D063-A22-Z06-H	●	63	6	22	40	3					4015-M4x11	80-T15	2407-M10x30
AFM43-OF05T3-D080-A27-Z07-H	●	80	7	27	50	3							2510-M12x35
AFM43-OF05T3-D125-B40-Z09	●	125	9	40	63	3							

R: Sağ / Right / Rechts! L: Sol / Left / Links

● Stokta / In Stock / Auf Lager ○ Stokta Yok / Non Stock Item / Kein Lagerartikel, Lieferzeit auf Anfrage

ISO Ucuna Uygundur. / Compatible with ISO Insert. / Kompatibel mit ISO Wendeplatten.

Sipariş Örneği/Ordering Example/Bestellbeispiel

1 ad./pcs./stück AFM90-VC2205-D050-A22-Z03-H

Kesme Hesabı : S 429 / Cutting Calculation : P 429 / Schnittberechnung : P 429

Sıkma Tork Değeri : S 428 / Tightening Torque : P 428 / Anzugsmoment : P 428

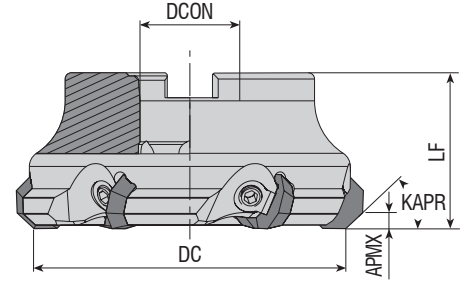

Takım Kodu Ordering Code Bestell-Bezeichnung	Stok Stock Lager	Takım Ölçüleri (mm) Dimension (mm) Abmessung (mm)					Kesici Uç Insert Wendeschneidplatte	Yedek Parçaları / Spare Parts / Ersatzteile			
		DC	ZEFP	DCON	LF	APMX		Baskı Parçası Wedge Clamp Spannpratze	Baskı Vidası Clamp Screw Klemmschraube	Anahtar Allen Key Innensechskantschlüssel	Montaj Vidası Mounting Screw Befestigungsschraube
AFM43C-0F07-D063-A22-Z04	●	63	4	22	45	5	OF.. 0704..	ACK-11	AKV-15-M8x1x20	AAL-05-4	2508-M10x30
AFM43C-0F07-D080-A27-Z05	●	80	5	27	50	5					2510-M12x35
AFM43C-0F07-D100-A32-Z06	●	100	6	32	50	5					2514-M16x35
AFM43C-0F07-D125-B40-Z08	●	125	8	40	63	5					-
AFM43C-0F07-D160-C40-Z09	●	160	9	40	63	5					-

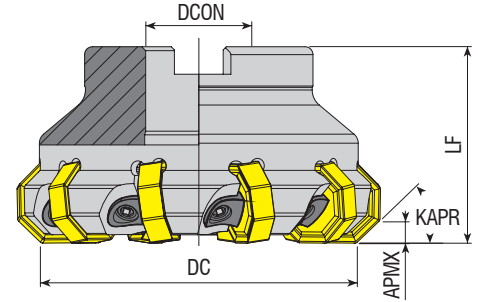

Takım Kodu Ordering Code Bestell-Bezeichnung	Stok Stock Lager	Takım Ölçüleri (mm) Dimension (mm) Abmessung (mm)					Kesici Uç Insert Wendeschneidplatte	Yedek Parçaları / Spare Parts / Ersatzteile			
		DC	ZEFP	DCON	LF	APMX		Baskı Parçası Wedge Clamp Spannpratze	Baskı Vidası Clamp Screw Klemmschraube	Anahtar Allen Key Innensechskantschlüssel	Montaj Vidası Mounting Screw Befestigungsschraube
AFM45C-0N0806-D063-A22-Z08	●	63	8	22	50	5.5	ON.. 0806..	ACK-26	AKV-26-M6x0.75x20	AAL-03-3	2508-M10x30
AFM45C-0N0806-D080-A27-Z10	●	80	10	27	50	5.5					2510-M12x35
AFM45C-0N0806-D100-A32-Z14	●	100	14	32	50	5.5					2514-M16x35
AFM45C-0N0806-D125-B40-Z18	●	125	18	40	63	5.5					-
AFM45C-0N0806-D160-C40-Z22	●	160	22	40	63	5.5					-

R: Sağ / Right / Rechts/ L: Sol / Left / Links

● Stokta / In Stock / Auf Lager ○ Stokta Yok / Non Stock Item / Kein Lagerartikel, Lieferzeit auf Anfrage

ISO Ucuca Uygundur. / Compatible with ISO Insert. / Kompatibel mit ISO Wendeplatten.

Sipariş Örneği/Ordering Example/Bestellbeispiel
1 ad./pcs./stück AFM43C-0F07-D063-A22-Z04
Kesme Hesabı : S 429 / Cutting Calculation : P 429 / Schnittberechnung : P 429

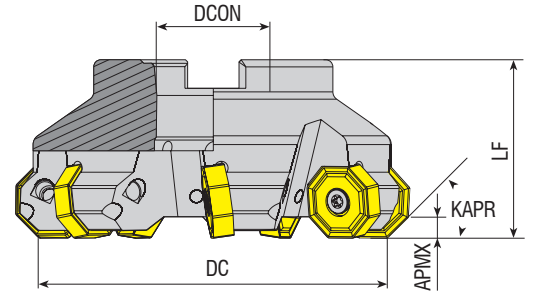
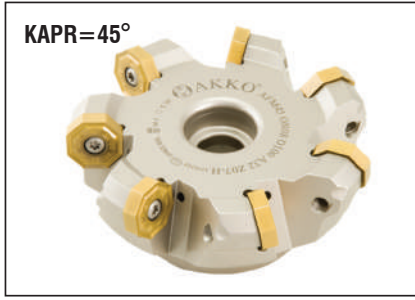

Takım Kodu Ordering Code Bestell-Bezeichnung	Stok Stock Lager	Takım Ölçüleri (mm) Dimension (mm) Abmessung (mm)					Kesici Uç Insert Wendeschneidplatte	Yedek Parçaları / Spare Parts / Ersatzteile			
		DC	ZEFP	DCON	LF	APMX		Sıkma Vidası Screw Schraube	Tork Anahtar Torx Key Torx-Schlüssel	Montaj Vidası Mounting Screw Befestigungsschraube	
AFM45-ON0806-D050-A22-Z04-H	●	50	4	22	40	5.5	ON.. 0806..	1020-M5x14	80-T20	-	
AFM45-ON0806-D063-A22-Z05-H	●	63	5	22	40	5.5				2508-M10x30	
AFM45-ON0806-D063-A22-Z06-H	●	63	6	22	40	5.5				2508-M2510-M10x30	
AFM45-ON0806-D063-A22-Z07-H	●	63	7	22	40	5.5				2510-M12x35	
AFM45-ON0806-D080-A27-Z06-H	●	80	6	27	50	5.5					
AFM45-ON0806-D080-A27-Z08-H	●	80	8	27	50	5.5					
AFM45-ON0806-D100-A32-Z07-H	●	100	7	32	50	5.5					
AFM45-ON0806-D100-A32-Z10-H	●	100	10	32	50	5.5					
AFM45-ON0806-D100-A32-Z10-H	●	100	10	32	50	5.5				2514-M16x35	
AFM45L-ON0806-D100-A32-Z10-H	●	100	10	32	50	5.5					
AFM45-ON0806-D125-B40-Z08	●	125	8	40	63	5.5					
AFM45L-ON0806-D125-B40-Z08	●	125	8	40	63	5.5					
AFM45-ON0806-D125-B40-Z12	●	125	12	40	63	5.5					
AFM45-ON0806-D160-C40-Z10	●	160	10	40	63	5.5					
AFM45-ON0806-D160-C40-Z14	●	160	14	40	63	5.5					
AFM45-ON0806-D200-C60-Z12	●	200	12	60	63	5.5					
AFM45-ON0806-D250-C60-Z14	●	250	14	60	63	5.5					
AFM45-ON0806-D315-D60-Z16	●	315	16	60	63	5.5					

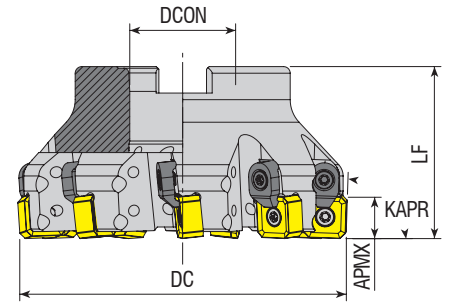
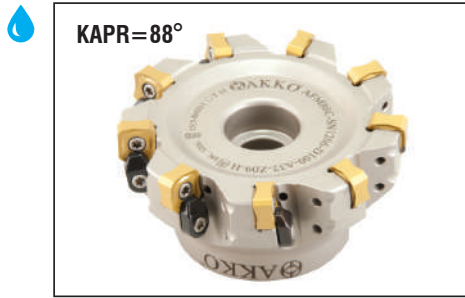

Takım Kodu Ordering Code Bestell-Bezeichnung	Stok Stock Lager	Takım Ölçüleri (mm) Dimension (mm) Abmessung (mm)					Kesici Uç Insert Wendeschneidplatte	Yedek Parçaları / Spare Parts / Ersatzteile				
		DC	ZEFP	DCON	LF	APMX		Sıkma Vidası Screw Schraube	Baskı Parçası Wedge Clamp Spannpratze	Baskı Vidası Clamp Screw Klemmschraube	Tork Anahtar Torx Key Torx-Schlüssel	Montaj Vidası Mounting Screw Befestigungsschraube
AFM88C-SN12..-D050-A22-Z05-H	●	50	5	22	40	11.5	SN.. 12..	1015-M4x11	ACK-05	4015-M4x11	80-T15	-
AFM88C-SN12..-D063-A22-Z06-H	●	63	6	22	40	11.5						2508-M10x30
AFM88C-SN12..-D080-A27-Z07-H	●	80	7	27	50	11.5						2510-M12x35
AFM88C-SN12..-D100-A32-Z09-H	●	100	9	32	52	11.5						2514-M16x35

R: Sağ / Right / Rechts L: Sol / Left / Links

● Stokta / In Stock / Auf Lager ○ Stokta Yok / Non Stock Item / Kein Lagerartikel, Lieferzeit auf Anfrage

ISO Ucuna Uygundur. / Compatible with ISO Insert. / Kompatibel mit ISO Wendeplatten.

Sipariş Örneği/Ordering Example/Bestellbeispiel

1 ad./pcs./stück AFM45-ON0806-D050-A22-Z04-H

Kesme Hesabı : S 429 / Cutting Calculation : P 429 / Schnittberechnung : P 429

Montaj Ölçüleri : S 426 / Mounting Reference : P 426 / Montagehinweis : P 426

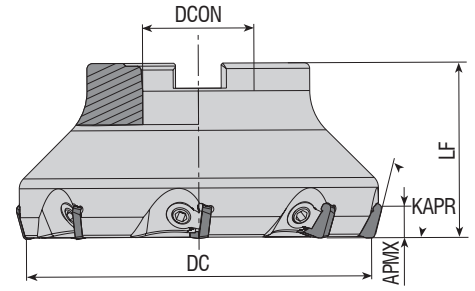

Takım Kodu Ordering Code Bestell-Bezeichnung	Stok Stock Lager	Takım Ölçüleri (mm) Dimension (mm) Abmessung (mm)					Kesici Uç Insert Wendeschneidplatte	Yedek Parçaları / Spare Parts / Ersatzteile			
		DC	ZEFP	DCON	LF	APMX		Baskı Parçası Wedge Clamp Spannpratze	Baskı Vidası Clamp Screw Klemmschraube	Anahtar Allen Key Innensechskantschlüssel	Montaj Vidası Mounting Screw Befestigungsschraube
AFM75C-SP12-D050-A22-Z04	●	50	4	22	42	8	SPKN 1203..	ACK-10	AKV-22-M8x1x14	AAL-05-4	2508-M10x30
AFM75C-SP12-D063-A22-Z05	●	63	5	22	40	8					
AFM75C-SP12-D080-A27-Z06	●	80	6	27	50	8					
AFM75C-SP12-D100-A32-Z07	●	100	7	32	50	8					
AFM75C-SP12-D125-B40-Z08	●	125	8	40	63	8					
AFM75C-SP12-D160-C40-Z09	●	160	9	40	63	8					
AFM75C-SP12-D200-C60-Z12	●	200	12	60	63	8					

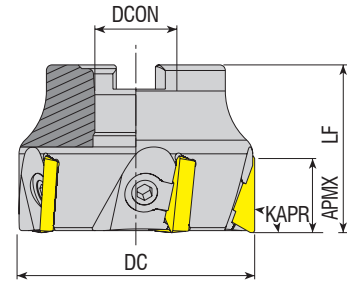

Takım Kodu Ordering Code Bestell-Bezeichnung	Stok Stock Lager	Takım Ölçüleri (mm) Dimension (mm) Abmessung (mm)					Kesici Uç Insert Wendeschneidplatte	Yedek Parçaları / Spare Parts / Ersatzteile			
		DC	ZEFP	DCON	LF	APMX		Baskı Parçası Wedge Clamp Spannpratze	Baskı Vidası Clamp Screw Klemmschraube	Anahtar Allen Key Innensechskantschlüssel	Montaj Vidası Mounting Screw Befestigungsschraube
AFM90C-TP16-D050-A22-Z04	●	50	4	22	40	12	TP. 1603..	ACK-10	AKV-22-M8x1x14	AAL-05-4	2407-M10x30
AFM90C-TP16-D063-A22-Z06	●	63	6	22	45	12					2508-M10x30
AFM90C-TP16-D080-A27-Z07	●	80	7	27	50	12					2510-M12x35
AFM90C-TP16-D100-A32-Z08	●	100	8	32	50	12					2514-M16x35
AFM90C-TP16-D125-B40-Z08	●	125	8	40	63	12					-
AFM90C-TP22-D063-A22-Z05	●	63	5	22	45	18	TP. 2204..	ACK-11	AKV-14-M8x1x18	AAL-05-4	2508-M10x30
AFM90C-TP22-D080-A27-Z06	●	80	6	27	50	18					2510-M12x35
AFM90C-TP22-D100-A32-Z07	●	100	7	32	50	18					2514-M16x35
AFM90C-TP22-D125-B40-Z08	●	125	8	40	63	18					-
AFM90C-TP22-D160-C40-Z09	●	160	9	40	63	18					-
AFM90C-TP22-D200-C60-Z12	●	200	12	60	63	18					-
AFM90C-TP22-D250-C60-Z15	●	250	15	60	63	18					-
AFM90C-TP22-D315-D60-Z18	●	315	18	60	63	18	-				

R: Sağ / Right / Rechts/ L: Sol / Left / Links
● Stokta / In Stock / Auf Lager ○ Stokta Yok / Non Stock Item / Kein Lagerartikel, Lieferzeit auf Anfrage
ISO Ucuca Uyğundur. / Compatible with ISO Insert. / Kompatibel mit ISO Wendeplatten.

Sipariş Örneği/Ordering Example/Bestellbeispiel
1 ad./pcs./stück AFM75C-SP12-D050-A22-Z04
Kesme Hesabı : S 429 / Cutting Calculation : P 429 / Schnittberechnung : P 429

KAPR=90°

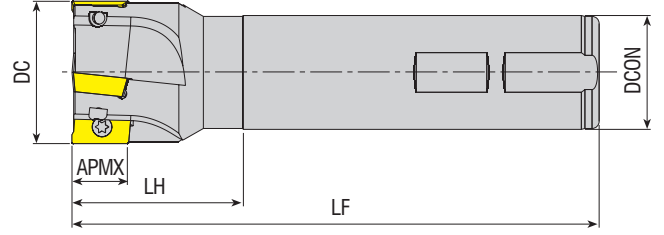

Takım Kodu Ordering Code Bestell-Bezeichnung	Stok Stock Lager	Takım Ölçüleri (mm) Dimension (mm) Abmessung (mm)						Kesici Uç Insert Wendeschneidplatte	Yedek Parçaları / Spare Parts / Ersatzteile	
		DC	ZEFP	DCON	LF	LH	APMX		Sıkma Vidası Screw Schraube	Tork Anahtar Torx Key Torx-Schlüssel
AEM90-AP1135A-D14-C16-L150-Z01	●	14	1	16	150	40	9.5	APMT 1135..	3008-M2.5x5	82-T08
AEM90-AP1135A-D16-C16-L150-Z02	●	16	2	16	150	40	9.5			
AEM90-AP1135A-D16-C16-L200-Z02	●	16	2	16	200	100	9.5			
AEM90-AP1135A-D16-C16-L250-Z02	●	16	2	16	250	150	9.5			
AEM90-AP1135A-D17-C16-L180-Z02	●	17	2	16	180	30	9.5			
AEM90-AP1135A-D20-C20-L150-Z03	●	20	3	20	150	50	9.5		3008-M2.5x6	
AEM90-AP1135A-D20-C20-L200-Z02	●	20	2	20	200	100	9.5			
AEM90-AP1135A-D21-C20-L180-Z02	●	21	2	20	180	30	9.5			
AEM90-AP1135A-D25-C25-L200-Z03	●	25	3	25	200	100	9.5			
AEM90-AP1135A-D26-C25-L250-Z02	●	26	2	25	250	35	9.5			
AEM90-AP1135A-D33-C32-L250-Z02	●	33	2	32	250	35	9.5			

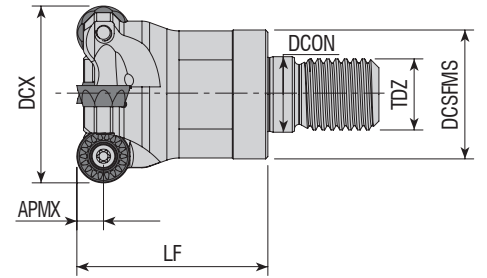

Takım Kodu Ordering Code Bestell-Bezeichnung	Stok Stock Lager	Takım Ölçüleri (mm) Dimension (mm) Abmessung (mm)						Kesici Uç Insert Wendeschneidplatte	Yedek Parçaları / Spare Parts / Ersatzteile		
		DCX	ZEFP	DCSFMS	TDZ	LF	DCON		APMX	Sıkma Vidası Screw Schraube	Tork Anahtar Torx Key Torx-Schlüssel
AEMR-RP10T3A-D32-M16-L43-Z04-H	●	32	4	29	M16	43	17	5	RPMW 10T3..	4015-M3.5x9	80-T15
AEMR-RP10T3A-D42-M16-L43-Z05-H	●	42	5	29	M16	43	17	5			

R: Sağ / Right / Rechts/ L: Sol / Left / Links

● Stokta / In Stock / Auf Lager ○ Stokta Yok / Non Stock Item / Kein Lagerartikel, Lieferzeit auf Anfrage

ACHTK Ucuna Uygun. / Compatible with ACHTK Insert. / Kompatibel mit ACHTK Wendeplatten.

Sipariş Örneği/Ordering Example/Bestellbeispiel

1 ad./pcs./stück AEM90-AP1135A-D14-C16-L150-Z01

Kesme Hesabı : S 429 / Cutting Calculation : P 429 / Schnittberechnung : P 429

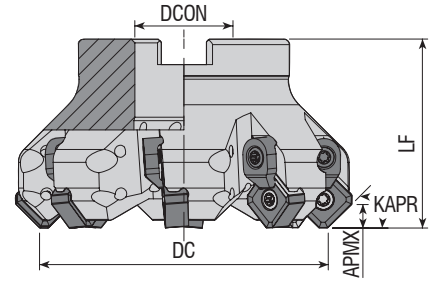

Takım Kodu Ordering Code Bestell-Bezeichnung	Stok Stock Lager	Takım Ölçüleri (mm) Dimension (mm) Abmessung (mm)					Kesici Uç Insert Wendeschneidplatte	Yedek Parçaları / Spare Parts / Ersatzteile				
		DC	ZEFP	DCON	LF	APMX		Sıkma Vidası Screw Schraube	Baskı Parçası Wedge Clamp Spannpratze	Baskı Vidası Clamp Screw Klemmschraube	Tork Anahtar Torx Key Torx-Schlüssel	Montaj Vidası Mounting Screw Befestigungsschraube
AFM45C-SN12..-D050-A22-Z04-H	●	50	4	22	42	6	SN.. 12..	1015-M4x11	ACK-05	4015-M4x11	80-T15	2407-M10x30
AFM45C-SN12..-D050-A22-Z05-H	●	50	5	22	42	6						
AFM45C-SN12..-D063-A22-Z06-H	●	63	6	22	42	6						
AFM45C-SN12..-D063-A22-Z07-H	●	63	7	22	42	6						
AFM45CL-SN12..-D063-A22-Z07-H	●	63	7	22	42	6						
AFM45C-SN12..-D080-A27-Z07-H	●	80	7	27	52	6						
AFM45C-SN12..-D080-A27-Z08-H	●	80	8	27	52	6						
AFM45CL-SN12..-D080-A27-Z08-H	●	80	8	27	52	6						
AFM45C-SN12..-D100-A32-Z08-H	●	100	8	32	52	6						
AFM45C-SN12..-D100-A32-Z10-H	●	100	10	32	52	6						
AFM45CL-SN12..-D100-A32-Z10-H	●	100	10	32	52	6						
AFM45C-SN12..-D125-B40-Z11	●	125	11	40	65	6						
AFM45CL-SN12..-D125-B40-Z11	●	125	11	40	65	6						
AFM45C-SN12..-D160-C40-Z12	●	160	12	40	65	6						
AFM45C-SN12..-D200-C60-Z14	●	200	14	60	65	6						
AFM45CL-SN12..-D200-C60-Z14	●	200	14	60	65	6						

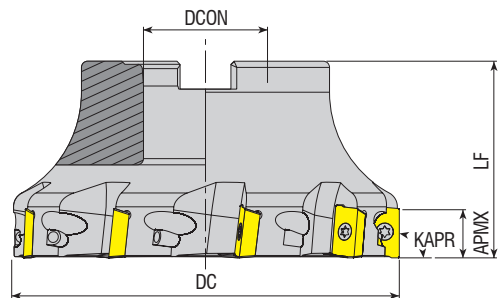

Takım Kodu Ordering Code Bestell-Bezeichnung	Stok Stock Lager	Takım Ölçüleri (mm) Dimension (mm) Abmessung (mm)					Kesici Uç Insert Wendeschneidplatte	Yedek Parçaları / Spare Parts / Ersatzteile		
		DC	ZEFP	DCON	LF	APMX		Sıkma Vidası Screw Schraube	Tork Anahtar Torx Key Torx-Schlüssel	Montaj Vidası Mounting Screw Befestigungsschraube
AFM90-AP16A-D040-A16-Z04-H	●	40	4	16	40	15	AP. 1604..	4015-M4x11	80-T15	2506-M8x30
AFM90-AP16A-D050-A22-Z05-H	●	50	5	22	40	15				2508-M10x30
AFM90-AP16A-D063-A22-Z06-H	●	63	6	22	40	15				2510-M12x35
AFM90-AP16A-D080-A27-Z07-H	●	80	7	27	50	15				2514-M16x35
AFM90-AP16A-D100-A32-Z08-H	●	100	8	32	50	15				-
AFM90-AP16A-D125-B40-Z09	●	125	9	40	63	15				-

R: Sağ / Right / Rechts! L: Sol / Left / Links

● Stokta / In Stock / Auf Lager ○ Stokta Yok / Non Stock Item / Kein Lagerartikel, Lieferzeit auf Anfrage

ACHTK Ucuna Uygundur. / Compatible with ACHTK Insert. / Kompatibel mit ACHTK Wendeplatten.

Sipariş Örneği/Ordering Example/Bestellbeispiel
1 ad./pcs./stück AFM45C-SN12..-D050-A22-Z04-H
Kesme Hesabı : S 429 / Cutting Calculation : P 429 / Schnittberechnung : P 429

BHLR Ucuna Uygundur. / Compatible with BHLR Insert. / Kompatibel mit BHLR Wendeplatten.

KAPR=45°

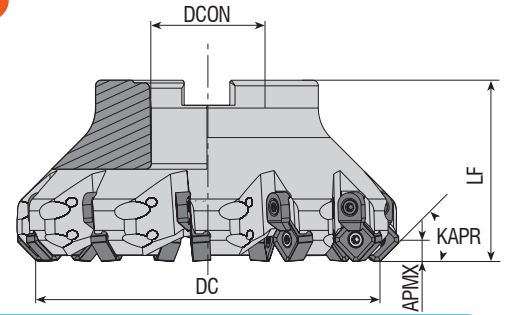

Takım Kodu Ordering Code Bestell-Bezeichnung	Stok Stock Lager	Takım Ölçüleri (mm) Dimension (mm) Abmessung (mm)					Kesici Uç Insert Wendeschneidplatte	Yedek Parçaları / Spare Parts / Ersatzteile					
		DC	ZEFP	DCON	LF	APMX		Sıkma Vidası Screw Schraube	Baskı Parçası Wedge Clamp Spannpratze	Baskı Vidası Clamp Screw Klemmschraube	Tork Anahtar Torx Key Torx-Schlüssel	Montaj Vidası Mounting Screw Befestigungsschraube	
AFM45C-SN1206-D050-A22-Z04-H	●	50	4	22	42	6	SN.. 1206..	4015-M4x11	ACK-05	4015-M4x11	80-T15	-	
AFM45CL-SN1206-D050-A22-Z05-H	●	50	5	22	42	6							
AFM45C-SN1206-D050-A22-Z05-H	●	50	5	22	42	6							
AFM45C-SN1206-D063-A22-Z06-H	●	63	6	22	42	6							2407-M10x30
AFM45C-SN1206-D063-A22-Z07-H	●	63	7	22	42	6							
AFM45CL-SN1206-D063-A22-Z07-H	●	63	7	22	42	6							2510-M12x35
AFM45C-SN1206-D080-A27-Z07-H	●	80	7	27	52	6							
AFM45C-SN1206-D080-A27-Z08-H	●	80	8	27	52	6							2514-M16x35
AFM45CL-SN1206-D080-A27-Z08-H	●	80	8	27	52	6							
AFM45C-SN1206-D100-A32-Z08-H	●	100	8	32	52	6							1015-M4x11
AFM45C-SN1206-D100-A32-Z10-H	●	100	10	32	52	6							
AFM45CL-SN1206-D100-A32-Z10-H	●	100	10	32	52	6							-
AFM45C-SN1206-D125-B40-Z11	●	125	11	40	65	6							
AFM45CL-SN1206-D125-B40-Z11	●	125	11	40	65	6							-
AFM45C-SN1206-D160-C40-Z12	●	160	12	40	65	6							
AFM45CL-SN1206-D160-C40-Z12	●	160	12	40	65	6							-
AFM45C-SN1206-D200-C60-Z14	●	200	14	60	65	6							
AFM45CL-SN1206-D200-C60-Z14	●	200	14	60	65	6							-

BHLR Ucuna Uygundur. / Compatible with BHLR Insert. / Kompatibel mit BHLR Wendeplatten.

B.OKE Ucuna Uygundur. / Compatible with B.OKE Insert. / Kompatibel mit B.OKE Wendeplatten.

KAPR=90°

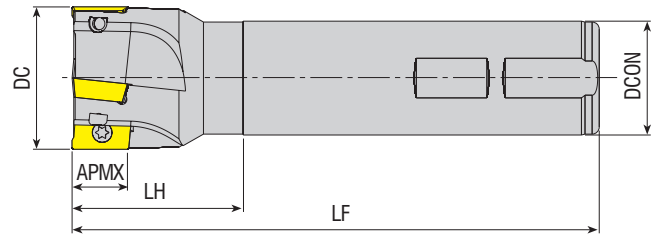

Takım Kodu Ordering Code Bestell-Bezeichnung	Stok Stock Lager	Takım Ölçüleri (mm) Dimension (mm) Abmessung (mm)						Kesici Uç Insert Wendeschneidplatte	Yedek Parçaları / Spare Parts / Ersatzteile	
		DC	ZEFP	DCON	LF	LH	APMX		Sıkma Vidası Screw Schraube	Tork Anahtar Torx Key Torx-Schlüssel
AEM90-AP100-D16-C15-L150-Z02	●	16	2	15	150	30	10	AP.. 1003..	3008-M2.5x6	82-T08
AEM90-AP100-D21-C20-L150-Z03	●	21	3	20	150	30	10			
AEM90-AP100-D26-C25-L150-Z04	●	26	4	25	150	35	10			
AEM90-AP100-D33-C32-L200-Z05	●	33	5	32	200	50	10			
AEM90-AP110-D16-C15-L150-Z02	●	16	2	5	150	30	11	AP.. 1135..	3008-M2.5x6	-
AEM90-AP110-D21-C20-L150-Z03	●	21	3	20	150	30	11			
AEM90-AP110-D26-C25-L150-Z04	●	26	4	25	150	35	11			
AEM90-AP110-D33-C32-L200-Z05	●	33	5	32	200	50	11			

B.OKE Ucuna Uygundur. / Compatible with B.OKE Insert. / Kompatibel mit B.OKE Wendeplatten.
Kesme Hesabı : S 429/ Cutting Calculation : P 429 / Schnittberechnung : P 429

Sipariş Örneği/Ordering Example/Bestellbeispiel
1 ad./pcs./stück AFM45C-SN1206-D050-A22-Z04-H

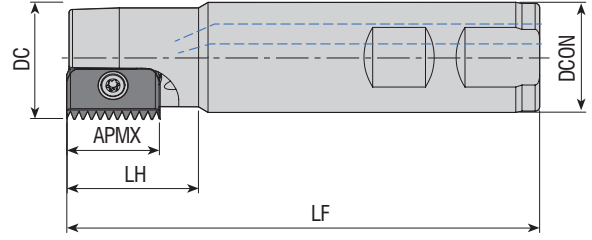

Takım Kodu Ordering Code Bestell-Bezeichnung	Stok Stock Lager	Takım Ölçüleri (mm) Dimension (mm) Abmessung (mm)						Kesici Uç Insert Wendeschneidplatte	Yedek Parçaları / Spare Parts / Ersatzteile	
		DC	ZEFP	DCON	LF	LH	APMX		Sıkma Vidası Screw Schraube	Tork Anahtar Torx Key Torx-Schlüssel
ATM-C14-D14-W20-L100-Z01-H	●	14	1	20	100	25	14	C14	3008-M2.5x6 4015-M4x9	82-T08
ATM-C21-D18-W20-L100-Z01-H	●	18	1	20	100	30	21			
ATM-C21-D21-W25-L125-Z01-H	●	21	1	25	125	40	21			
ATM-C21-D25-W20-L125-Z01-H	●	25	1	20	125	30	21	C21	4015-M4x11	80-T15
ATM-C21-D28-W25-L90-Z01-H	●	28	1	25	90	30	21			
ATM-C21-D38-W32-L90-Z03-H	●	38	3	32	90	30	21			
ATM-C21-D38-W32-L120-Z03-H	●	38	3	32	120	40	21	C30	1020-M5x14	80-T20
ATM-C21-D43-W32-L90-Z03-H	●	43	3	32	90	30	21			
ATM-C30-D29-W25-L150-Z01-H	●	29	1	25	150	50	30			

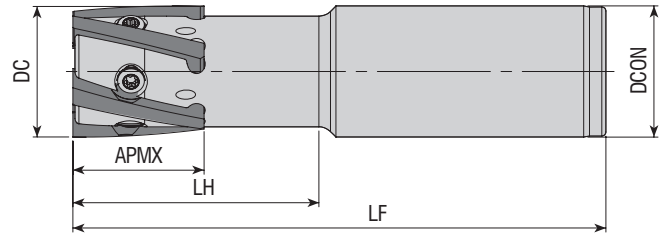

Takım Kodu Ordering Code Bestell-Bezeichnung	Stok Stock Lager	Takım Ölçüleri (mm) Dimension (mm) Abmessung (mm)						Kesici Uç Insert Wendeschneidplatte	Yedek Parçaları / Spare Parts / Ersatzteile	
		DC	ZEFP	DCON	LF	LH	APMX		Sıkma Vidası Screw Schraube	Tork Anahtar Torx Key Torx-Schlüssel
ATM-H23-D23-C25-L100-Z02-H	●	23	2	25	100	30	27	H23	1015-M4x8	80-T15
ATM-H32-D32-C32-L130-Z05-H	●	32	5	32	130	35	32			

R: Sağ / Right / Rechts/ L: Sol / Left / Links

● Stokta / In Stock / Auf Lager ○ Stokta Yok / Non Stock Item / Kein Lagerartikel, Lieferzeit auf Anfrage



CPT Ucuna Uygundur. / Compatible with CPT Insert. / Kompatibel mit CPT Wendeplatten.

Sipariş Örneği/Ordering Example/Bestellbeispiel



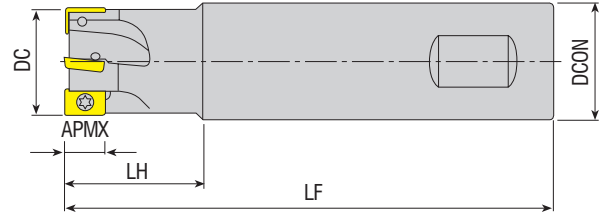

1 ad./pcs./stück ATM-C14-D14-W20-L100-Z01-H

Kesme Hesabı : S 429/ Cutting Calculation : P 429 / Schnittberechnung : P 429

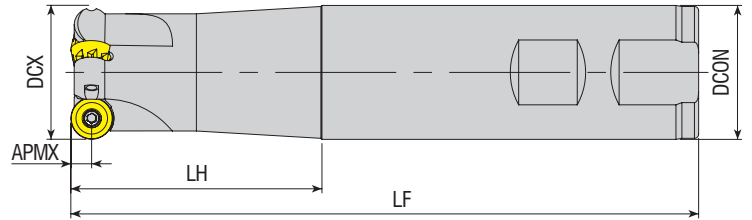

Takım Kodu Ordering Code Bestell-Bezeichnung	Stok Stock Lager	Takım Ölçüleri (mm) Dimension (mm) Abmessung (mm)						Kesici Uç Insert Wendeschneidplatte	Yedek Parçaları / Spare Parts / Ersatzteile		
		DC	ZEFP	DCON	LF	LH	APMX		Sıkma Vidası Screw Schraube	Tork Anahtar Torx Key Torx-Schlüssel	
AEM90-XD11T3-D16-W16-L150-Z02	●	16	2	16	150	30	10				
AEM90-XD11T3-D17-C16-L150-Z02	●	17	2	16	150	30	10				
AEM90-XD11T3-D20-W20-L150-Z03	●	20	3	20	150	50	10				
AEM90-XD11T3-D21-C20-L080-Z03-H	●	21	3	20	80	25	10		3008-M2.5x6	82-T08	
AEM90-XD11T3-D21-C20-L150-Z03	●	21	3	20	150	30	10				
AEM90-XD11T3-D25-W25-L150-Z04	●	25	4	25	150	50	10				
AEM90-XD11T3-D30-W25-L120-Z04	●	30	4	25	120	30	10				
AEM90-XD11T3-D32-W32-L150-Z04	●	32	4	32	150	50	10				
AEM90-XD11T3-D33-C20-L080-Z04-H	●	33	4	20	80	30	10				



Takım Kodu Ordering Code Bestell-Bezeichnung	Stok Stock Lager	Takım Ölçüleri (mm) Dimension (mm) Abmessung (mm)						Kesici Uç Insert Wendeschneidplatte	Yedek Parçaları / Spare Parts / Ersatzteile			
		DCX	ZEFP	DCON	LF	LH	APMX		Sıkma Vidası Screw Schraube	Baskı Parçası Wedge Clamp Spannpratze	Baskı Vidası Clamp Screw Schraube	Tork Anahtar Torx Key Torx-Schlüssel
AEMR-RP10T3-D25-W25-L125-Z02	●	25	2	25	125	60	5					
AEMR-RP10T3-D25-W25-L150-Z02	●	25	2	25	150	60	5					
AEMR-RP10T3-D32-W32-L150-Z03	●	32	3	32	150	60	5					

R: Sağ / Right / Rechts / L: Sol / Left / Links

● Stokta / In Stock / Auf Lager ○ Stokta Yok / Non Stock Item / Kein Lagerartikel, Lieferzeit auf Anfrage

CRTZT Ucuna Uygundur. / Compatible with CRTZT Insert. / Kompatibel mit CRTZT Wendeplatten.

Sipariş Örneği/Ordering Example/Bestellbeispiel

1 ad./pcs./stück AEM90-XD11T3-D16-W16-L150-Z02

Kesme Hesabı : S 429 / Cutting Calculation : P 429 / Schnittberechnung : P 429

Sıkma Tork Değeri : S 428 / Tightening Torque : P 428 / Anzugsmoment : P 428

CRTZT Ucuna Uygunur. / Compatible with CRTZT Insert. / Kompatibel mit CRTZT Wendeplatten.

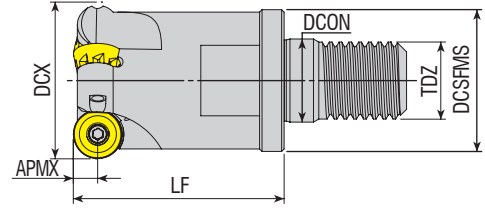

Takım Kodu Ordering Code Bestell-Bezeichnung	Stok Stock Lager	Takım Ölçüleri (mm) Dimension (mm) Abmessung (mm)							Kesici Uç Insert Wendeschneidplatte	Yedek Parçaları / Spare Parts / Ersatzteile		
		DCX	ZEFP	DCSFMS	TDZ	LF	DCON	APMX		Sıkma Vidası Screw Schraube	Tork Anahtar Torx Key Torx-Schlüssel	
AEMR-RP10T3-D25-M12-L35-Z02-H	●	25	2	21	M12	35	12.5	5				
AEMR-RP10T3-D32-M16-L43-Z03-H	●	32	3	29	M16	43	17	5				
AEMR-RP1204-D32-M16-L43-Z03-H	●	32	3	29	M16	43	17	6	RPNX 1204..	4015-M4x9	80-T15	

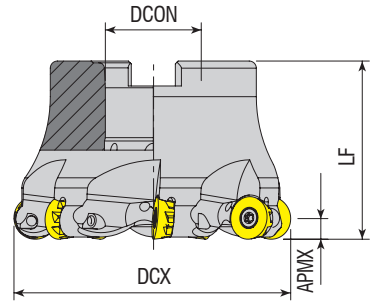

Takım Kodu Ordering Code Bestell-Bezeichnung	Stok Stock Lager	Takım Ölçüleri (mm) Dimension (mm) Abmessung (mm)					Kesici Uç Insert Wendeschneidplatte	Yedek Parçaları / Spare Parts / Ersatzteile			
		DCX	ZEFP	DCON	LF	APMX		Sıkma Vidası Screw Schraube	Tork Anahtar Torx Key Torx-Schlüssel	Montaj Vidası Mounting Screw Befestigungsschraube	
AFMR-RP10T3-D063-A22-Z06-H	●	63	6	22	40	5					
AFMR-RP10T3-D080-A27-Z07-H	●	80	7	27	50	5					
AFMR-RP1204-D040-A16-Z04-H	●	40	4	16	40	6	RPNX 1204..				
new AFMR-RP1204-D050-A22-Z05-H	●	50	5	22	40	6					
AFMR-RP1204-D080-A27-Z07-H	●	80	7	27	50	6					

R: Sağ / Right / Rechts/ L: Sol / Left / Links

● Stokta / In Stock / Auf Lager ○ Stokta Yok / Non Stock Item / Kein Lagerartikel, Lieferzeit auf Anfrage

CRTZT Ucuna Uygunur. / Compatible with CRTZT Insert. / Kompatibel mit CRTZT Wendeplatten.

Sipariş Örneği/Ordering Example/Bestellbeispiel

1 ad./pcs./stück AEMR-RP10T3-D25-M12-L35-Z02-H

CRTZT Ucuna Uygunur. / Compatible with CRTZT Insert. / Kompatibel mit CRTZT Wendeplatten.

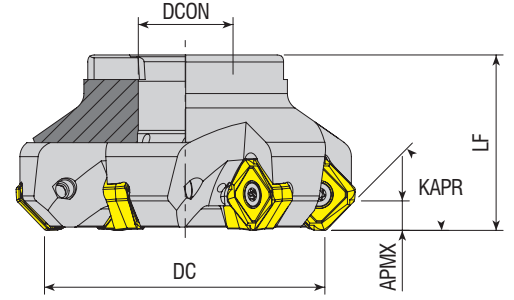

Takım Kodu Ordering Code Bestell-Bezeichnung	Stok Stock Lager	Takım Ölçüleri (mm) Dimension (mm) Abmessung (mm)					Kesici Uç Insert Wendeschneidplatte	Yedek Parçaları / Spare Parts / Ersatzteile		
		DC	ZEFP	DCON	LF	APMX		Sıkma Vidası Screw Schraube	Tork Anahtar Torx Key Torx-Schlüssel	Montaj Vidası Mounting Screw Befestigungsschraube
AFM45-SA1706-D080-A27-Z06-H	●	80	6	27	50	8.4	SAKU 1706..			2510-M12x35
AFM45-SA1706-D100-A32-Z07-H	●	100	7	32	50	8.4				2514-M16x35
AFM45-SA1706-D125-B40-Z09	●	125	9	40	63	8.4				-

CRTZT Ucuna Uygunur. / Compatible with CRTZT Insert. / Kompatibel mit CRTZT Wendeplatten.

DJT Ucuna Uygunur. / Compatible with DJT Insert. / Kompatibel mit DJT Wendeplatten.

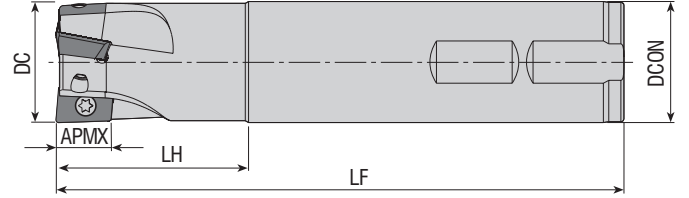

Takım Kodu Ordering Code Bestell-Bezeichnung	Stok Stock Lager	Takım Ölçüleri (mm) Dimension (mm) Abmessung (mm)						Kesici Uç Insert Wendeschneidplatte	Yedek Parçaları / Spare Parts / Ersatzteile	
		DC	ZEFP	DCON	LF	LH	APMX		Sıkma Vidası Screw Schraube	Tork Anahtar Torx Key Torx-Schlüssel
AEM90-AD1003-D16-C16-L150-Z02	●	16	2	16	150	30	8	ADMT 1003..		
AEM90-AD1003-D17-C16-L150-Z02	●	17	2	16	150	25	8			
AEM90-AD1003-D20-C20-L200-Z03	●	20	3	20	200	50	8			
AEM90-AD1003-D21-C20-L150-Z03	●	21	3	20	150	25	8			
AEM90-AD1003-D21-C20-L200-Z03	●	21	3	20	200	25	8			
AEM90-AD1003-D25-C25-L200-Z03	●	25	3	25	200	50	8			
AEM90-AD1003-D26-C25-L150-Z03	●	26	3	25	150	30	8			
AEM90-AD1003-D26-C25-L200-Z03	●	26	3	25	200	30	8			
AEM90-AD1505D-D25-W25-L150-Z02	●	25	2	25	150	50	14.3	ADKT 1505..		
AEM90-AD1505D-D32-W32-L150-Z03	●	32	3	32	150	50	14.3			

R: Sağ / Right / Rechts L: Sol / Left / Links

● Stokta / In Stock / Auf Lager ○ Stokta Yok / Non Stock Item / Kein Lagerartikel, Lieferzeit auf Anfrage

DJT Ucuna Uygunur. / Compatible with DJT Insert. / Kompatibel mit DJT Wendeplatten.



Sipariş Örneği/Ordering Example/Bestellbeispiel

1 ad./pcs./stück AFM45-SA1706-D080-A27-Z06-H



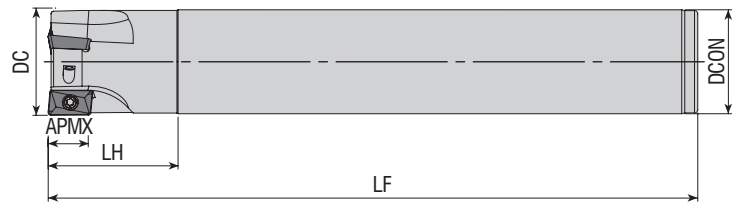

Kesme Hesabı : S 429 / Cutting Calculation : P 429 / Schnittberechnung : P 429

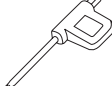
Montaj Ölçüleri : S 426 / Mounting Reference : P 426 / Montagehinweis : P 426

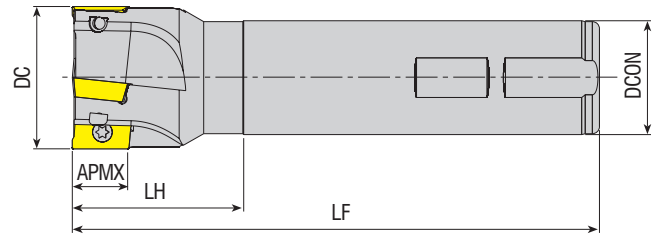

Takım Kodu Ordering Code Bestell-Bezeichnung	Stok Stock Lager	Takım Ölçüleri (mm) Dimension (mm) Abmessung (mm)						Kesici Uç Insert Wendeschneidplatte	Yedek Parçaları / Spare Parts / Ersatzteile		
		DC	ZEFP	DCON	LF	LH	APMX		Sıkma Vidası Screw Schraube	Tork Anahtar Torx Key Torx-Schlüssel	
AEM90-ZP13T3-D26-C25-L200-Z02	●	26	2	25	200	35	13				
AEM90-ZP13T3-D26-C25-L200-Z03	●	26	3	25	200	35	13				
AEM90-ZP13T3-D26-C25-L250-Z02	●	26	2	25	250	35	13				
AEM90-ZP13T3-D33-C32-L200-Z03	●	33	3	32	200	40	13				
AEM90-ZP13T3-D33-C32-L250-Z03	●	33	3	32	250	40	13				

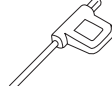

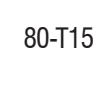
Takım Kodu Ordering Code Bestell-Bezeichnung	Stok Stock Lager	Takım Ölçüleri (mm) Dimension (mm) Abmessung (mm)						Kesici Uç Insert Wendeschneidplatte	Yedek Parçaları / Spare Parts / Ersatzteile		
		DC	ZEFP	DCON	LF	LH	APMX		Sıkma Vidası Screw Schraube	Tork Anahtar Torx Key Torx-Schlüssel	
AEM90-AP10D-D16-W16-L150-Z02	●	16	2	16	150	50	10				
AEM90-AP10D-D20-W20-L150-Z03	●	20	3	20	150	50	10				
AEM90-AP10D-D25-W20-L150-Z03	●	25	3	20	150	30	10				
AEM90-AP16DJ-D25-W25-L150-Z02	●	25	2	25	150	50	16				
AEM90-AP16DJ-D25-C25-L200-Z02	●	25	2	25	200	50	16				
AEM90-AP16DJ-D32-W32-L150-Z03	●	32	3	32	150	50	16				
AEM90-AP16DJ-D32-C32-L180-Z03	●	32	3	32	180	50	16				
AEM90-AP16DJ-D32-C32-L200-Z03	●	32	3	32	200	50	16				

R: Sağ / Right / Rechts / L: Sol / Left / Links

● Stokta / In Stock / Auf Lager ○ Stokta Yok / Non Stock Item / Kein Lagerartikel, Lieferzeit auf Anfrage

DJT Ucuna Uygundur. / Compatible with DJT Insert. / Kompatibel mit DJT Wendeplatten.

Sipariş Örneği/Ordering Example/Bestellbeispiel

1 ad./pcs./stück AEM90-ZP13T3-D26-C25-L200-Z02

Kesme Hesabı : S 429/ Cutting Calculation : P 429 / Schnittberechnung : P 429

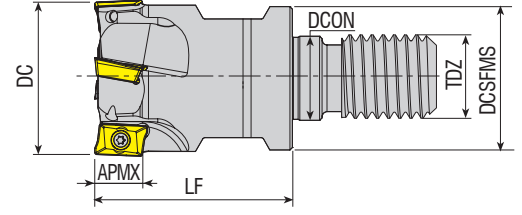

Takım Kodu Ordering Code Bestell-Bezeichnung	Stok Stock Lager	Takım Ölçüleri (mm) Dimension (mm) Abmessung (mm)							Kesici Uç Insert Wendeschneidplatte	Yedek Parçaları / Spare Parts / Ersatzteile		
		DC	ZEFP	DCSFMS	TDZ	LF	DCON	APMX		Sıkma Vidası Screw Schraube	Tork Anahtar Torx Key Torx-Schlüssel	
AEM90-AP10D-D16-M08-L30-Z02-H	●	16	2	14.75	M08	30	8.5	10	AP. 1003..	3008-M2.5x6	82-T08	
AEM90-AP10D-D20-M10-L30-Z03-H	●	20	3	18	M10	30	10.5	10				
AEM90-AP10D-D25-M12-L35-Z03-H	●	25	3	21	M12	35	12.5	10				
AEM90-AP16DJ-D25-M12-L43-Z02-H	●	25	2	21	M12	43	12.5	16	AP. 1604..	4015-M4x9	80-T15	
AEM90-AP16DJ-D32-M16-L43-Z03-H	●	32	3	29	M16	43	17	16				
AEM90-AP16DJ-D40-M16-L43-Z04-H	●	40	4	29	M16	43	17	16				

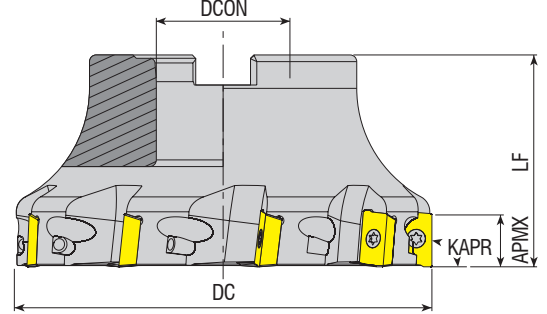

Takım Kodu Ordering Code Bestell-Bezeichnung	Stok Stock Lager	Takım Ölçüleri (mm) Dimension (mm) Abmessung (mm)					Kesici Uç Insert Wendeschneidplatte	Yedek Parçaları / Spare Parts / Ersatzteile			
		DC	ZEFP	DCON	LF	APMX		Sıkma Vidası Screw Schraube	Tork Anahtar Torx Key Torx-Schlüssel	Montaj Vidası Mounting Screw Befestigungsschraube	
AFM90-AP16DJ-D050-A22-Z05-H	●	50	5	22	40	16	AP. 1604..	4015-M4x11	80-T15	2508-M10x30 2510-M12x35	
AFM90-AP16DJ-D063-A22-Z06-H	●	63	6	22	40	16					
AFM90-AP16DJ-D080-A27-Z07-H	●	80	7	27	50	16					

● Stokta / In Stock / Auf Lager ○ Stokta Yok / Non Stock Item / Kein Lagerartikel, Lieferzeit auf Anfrage
DJT Ucuna Uygundur. / Compatible with DJT Insert. / Kompatibel mit DJT Wendeplatten.

Sipariş Örneği/Ordering Example/Bestellbeispiel
1 ad./pcs./stück AEM90-AP10D-D16-M08-L30-Z02-H

Kesme Hesabı : S 429 / Cutting Calculation : P 429 / Schnittberechnung : P 429
Montaj Ölçüleri : S 426 / Mounting Reference : P 426 / Montagehinweis : P 426

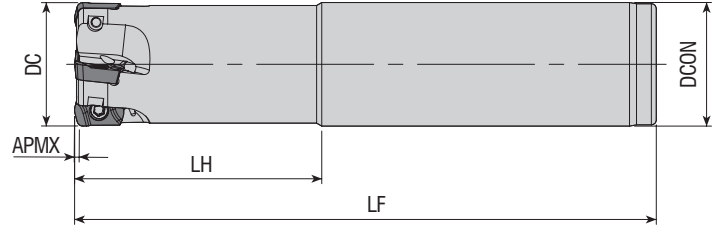

Takım Kodu Ordering Code Bestell-Bezeichnung	Stok Stock Lager	Takım Ölçüleri (mm) Dimension (mm) Abmessung (mm)						Kesici Uç Insert Wendeschneidplatte	Yedek Parçaları / Spare Parts / Ersatzteile	
		DC	ZEFP	DCON	LF	LH	APMX		Sıkma Vidası Screw Schraube	Tork Anahtar Torx Key Torx-Schlüssel
AHFM-YP1003-D16-C15-L150-Z02-F	●	16	2	15	150	20	1			
AHFM-YP1003-D16-C15-L200-Z02-F	●	16	2	15	200	20	1			
AHFM-YP1003-D16-C16-L150-Z02-F	●	16	2	16	150	50	1			
AHFM-YP1003-D17-C16-L150-Z02-F	●	17	2	16	150	20	1			
AHFM-YP1003-D17-C16-L200-Z02-F	●	17	2	16	200	20	1			
AHFM-YP1003-D20-C18-L150-Z03-F	●	20	3	18	150	25	1			
AHFM-YP1003-D20-C18-L200-Z03-F	●	20	3	18	200	25	1			
AHFM-YP1003-D20-C20-L150-Z03-F	●	20	3	20	150	50	1			
AHFM-YP1003-D21-C20-L150-Z03-F	●	21	3	20	150	20	1			
AHFM-YP1003-D21-C20-L150-Z03-H	●	21	3	20	150	20	1			
AHFM-YP1003-D21-C20-L150-Z04-F	●	21	4	20	150	20	1			
AHFM-YP1003-D21-C20-L200-Z03	●	21	3	20	200	20	1			
AHFM-YP1003-D21-C20-L200-Z03-F	●	21	3	20	200	20	1			
AHFM-YP1003-D25-C20-L150-Z04-F	●	25	4	20	150	25	1			
AHFM-YP1003-D25-C20-L200-Z04-F	●	25	4	20	200	25	1			
AHFM-YP1003-D25-C25-L150-Z04-F	●	25	4	25	150	50	1			
AHFM-YP1003-D26-C25-L150-Z04	●	26	4	25	150	30	1			
AHFM-YP1003-D25-C25-L150-Z04-H	●	25	4	25	150	50	1			
AHFM-YP1003-D26-C25-L150-Z04-F	●	26	4	25	150	30	1			
AHFM-YP1003-D26-C25-L250-Z04-F	●	26	4	25	250	30	1			
AHFM-YP1003-D26-C25-L200-Z03-F	●	26	3	25	200	30	1			
AHFM-YP1003-D26-C25-L200-Z04-F	●	26	4	25	200	30	1			
AHFM-YP1003-D33-C32-L200-Z04-F	●	33	4	32	200	30	1			
AHFM-YP1003-D33-C32-L250-Z04-F	●	33	4	32	250	30	1			
AHFM-YP1003-D33-C32-L300-Z04-F	●	33	4	32	300	30	1			

R: Sağ / Right / Rechts! L: Sol / Left / Links

● Stokta / In Stock / Auf Lager ○ Stokta Yok / Non Stock Item / Kein Lagerartikel, Lieferzeit auf Anfrage

DJT Ucuna Uygundur. / Compatible with DJT Insert. / Kompatibel mit DJT Wendeplatten.

Çap Ölçüsü - 0,02 mm Olarak üretiliyor. F: ± 0,02 mm Demektir. Ör: Ø16 Takım 15,98 ± 0,02 mm yani 16,00 mm - 15,96 mm Olmalıdır.

Diameter Size is produced as - 0.02 mm. F: means ± 0,02 mm. For example: Ø16 tool 15.98 ± 0,02 mm, it means that it should be 16,00 mm - 15,96 mm.

Durchmesser - Es wird mit -0,02 mm hergestellt. Das heißt F: ± 0,02 mm. Zum Beispiel: Der Ø16-Satz sollte 15,98 ± 0,02 mm, 16,00 mm - 15,96 mm betragen.

Sipariş Örneği/Ordering Example/Bestellbeispiel

1 ad./pcs./stück AHFM-YP1003-D16-C15-L150-Z02-F

Kesme Hesabı : S 429/ Cutting Calculation : P 429 / Schnittberechnung : P 429



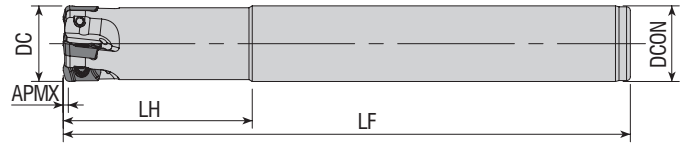

Takım Kodu Ordering Code Bestell-Bezeichnung	Stok Stock Lager	Takım Ölçüleri (mm) Dimension (mm) Abmessung (mm)						Kesici Uç Insert Wendescheidplatte	Yedek Parçaları / Spare Parts / Ersatzteile	
		DC	ZEFP	DCON	LF	LH	APMX		Sıkma Vidası Screw Schraube	Tork Anahtar Torx Key Torx-Schlüssel
AHFM-EP1003-D16-C16-L80-Z02-H	●	16	2	16	80	20	1	EP. 1003.. ZPMT 1003.. YPHW 1003..	3008-M2.5x5	82-T08
AHFM-EP1003-D16-C16-L150-Z02-H	●	16	2	16	150	50	1			
AHFM-EP1003-D17-C16-L150-Z02-H	●	17	2	16	150	20	1			
AHFM-EP1003-D20-C20-L150-Z04-H	●	20	4	20	150	50	1			
AHFM-EP1003-D21-C20-L150-Z04-H	●	21	4	20	150	20	1			
AHFM-EP1003-D25-C25-L200-Z04-H	●	25	4	25	200	100	1			
AHFM-EP1003-D25-C25-L250-Z04-H	●	25	4	25	250	100	1		3008-M2.5x6	

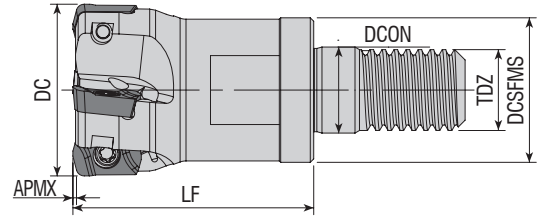

Takım Kodu Ordering Code Bestell-Bezeichnung	Stok Stock Lager	Takım Ölçüleri (mm) Dimension (mm) Abmessung (mm)							Kesici Uç Insert Wendescheidplatte	Yedek Parçaları / Spare Parts / Ersatzteile	
		DC	ZEFP	DCSFMS	TDZ	LF	DCON	APMX		Sıkma Vidası Screw Schraube	Tork Anahtar Torx Key Torx-Schlüssel
AHFM-EP1003-D16-M08-L23-Z02	●	16	2	14.75	M08	23	8.5	1	EP. 1003.. ZPMT 1003.. YPHW 1003..	3008-M2.5x5	82-T08
AHFM-EP1003-D16-M08-L23-Z02-H	●	16	2	14.75	M08	23	8.5	1			
AHFM-EP1003-D20-M10-L30-Z03	●	20	3	18	M10	30	10.5	1			
AHFM-EP1003-D20-M10-L30-Z04-H	●	20	4	18	M10	30	10.5	1			
AHFM-EP1003-D25-M12-L35-Z04-H	●	25	4	21	M12	35	12.5	1			
AHFM-EP1003-D32-M16-L43-Z05-H	●	32	5	29	M16	43	17	1			
AHFM-EP1003-D35-M16-L43-Z05-H	●	35	5	29	M16	43	17	1			
AHFM-EP1003-D42-M16-L43-Z06-H	●	42	6	29	M16	43	17	1			
										3008-M2.5x6	

R: Sağ / Right / Rechts/ L: Sol / Left / Links

● Stokta / In Stock / Auf Lager ○ Stokta Yok / Non Stock Item / Kein Lagerartikel, Lieferzeit auf Anfrage

DJT Ucuna Uygundur. / Compatible with DJT Insert. / Kompatibel mit DJT Wendeplatten.

Sipariş Örneği/Ordering Example/Bestellbeispiel

1 ad./pcs./stück AHFM-EP1003-D16-C16-L80-Z02-H

Kesme Hesabı : S 429/ Cutting Calculation : P 429 / Schnittberechnung : P 429

Sıkma Tork Değeri : S 428 / Tightening Torque : P 428 / Anzugsmoment : P 428

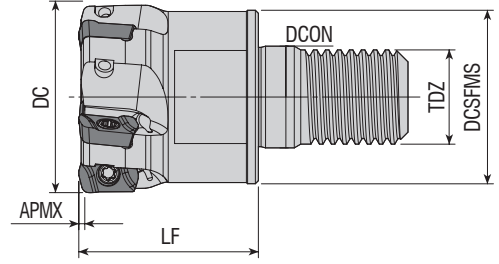

Takım Kodu Ordering Code Bestell-Bezeichnung	Stok Stock Lager	Takım Ölçüleri (mm) Dimension (mm) Abmessung (mm)						Kesici Uç Insert Wendeschneidplatte	Yedek Parçaları / Spare Parts / Ersatzteile				
		DC	ZEP	DCSFMS	TDZ	LF	DCON		APMX	Sıkma Vidası Screw Schraube	Baskı Parçası Wedge Clamp Spannpratze	Baskı Vidası Clamp Screw Schraube	Tork Anahtar Torx Key Torx-Schlüssel
AHFM-YP1003-D16-M08-L23-Z02-F	●	16	2	14.75	M08	23	8.5	1	EP. 1003.. ZPMT 1003.. YPHW 1003..	3008-M2.5x5	-	-	82-T08
AHFM-YP1003-D16-M08-L23-Z02-H-F	●	16	2	14.75	M08	23	8.5	1					
AHFM-YP1003-D17-M08-L23-Z02-H	●	17	2	14.75	M08	23	8.5	1					
AHFM-YP1003-D17-M08-L23-Z02-H-F	●	17	2	14.75	M08	23	8.5	1					
AHFM-YP1003-D20-M10-L30-Z03-H	●	20	3	18	M10	30	10.5	1					
AHFM-YP1003-D20-M10-L30-Z03-H-F	●	20	3	18	M10	30	10.5	1					
AHFM-YP1003-D20-M10-L30-Z04-H	●	20	4	18	M10	30	10.5	1					
AHFM-YP1003-D20-M10-L30-Z04-F	●	20	4	18	M10	30	10.5	1					
AHFM-YP1003-D21-M10-L30-Z03-H	●	21	3	18	M10	30	10.5	1					
AHFM-YP1003-D21-M10-L30-Z03-H-F	●	21	3	18	M10	30	10.5	1					
AHFM-YP1003-D25-M12-L35-Z04-H	●	25	4	21	M12	35	12.5	1					
AHFM-YP1003-D25-M12-L35-Z04-F	●	25	4	21	M12	35	12.5	1					
AHFM-YP1003-D25-M12-L35-Z04-H-F	●	25	4	21	M12	35	12.5	1					
AHFM-YP1003-D26-M12-L35-Z04-H-F	●	26	4	21	M12	35	12.5	1					
AHFM-YP1003-D32-M16-L30-Z05-F	●	32	5	29	M16	30	17	1		3008-M2.5x6			
AHFM-YP1003-D32-M16-L43-Z05-H-F	●	32	5	29	M16	43	17	1					
AHFM-YP1003-D40-M16-L43-Z06-H-F	●	40	6	29	M16	43	17	1					
AHFM-YP1003-D42-M16-L43-Z06-H-F	●	42	6	29	M16	43	17	1					

R: Sağ / Right / Rechts/ L: Sol / Left / Links

● Stokta / In Stock / Auf Lager ○ Stokta Yok / Non Stock Item / Kein Lagerartikel, Lieferzeit auf Anfrage

DJT Ucuna Uygunur. / Compatible with DJT Insert. / Kompatibel mit DJT Wendeplatten.

Çap Ölçüsü - 0,02 mm Olarak üretiliyor. F: ± 0,02 mm Demektir. Ör: Ø16 Takım 15,98 ± 0,02 mm yani 16,00 mm - 15,96 mm Olmalıdır.

Diameter Size is produced as - 0.02 mm. F: means ± 0,02 mm. For example: Ø16 tool 15,98 ± 0,02 mm, it means that it should be 16,00 mm - 15,96 mm.

Durchmesser - Es wird mit -0,02 mm hergestellt. Das heißt F: ± 0,02 mm. Zum Beispiel: Der Ø16-Satz sollte 15,98 ± 0,02 mm, 16,00 mm - 15,96 mm betragen.

Sipariş Örneği/Ordering Example/Bestellbeispiel

1 ad./pcs./stück AHFM-YP1003-D16-M08-L23-Z02-F

Kesme Hesabı : S 429 / Cutting Calculation : P 429 / Schnittberechnung : P 429

Sıkma Tork Değeri : S 428 / Tightening Torque : P 428 / Anzugsmoment : P 428

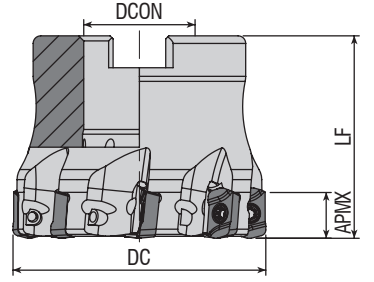

Takım Kodu Ordering Code Bestell-Bezeichnung	Stok Stock Lager	Takım Ölçüleri (mm) Dimension (mm) Abmessung (mm)					Kesici Uç Insert Wendescheidplatte	Yedek Parçaları / Spare Parts / Ersatzteile		
		DC	ZEFP	DCON	LF	APMX		Sıkma Vidası Screw Schraube	Tork Anahtar Torx Key Torx-Schlüssel	Montaj Vidası Mounting Screw Befestigungsschraube
AHFM-EP1003-D050-A22-Z08-H	●	50	8	22	40	1				
AHFM-EP1003-D063-A22-Z08-H	●	63	8	22	40	1				

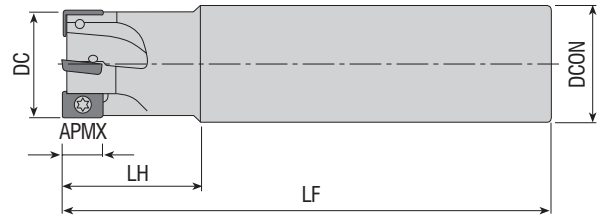

Takım Kodu Ordering Code Bestell-Bezeichnung	Stok Stock Lager	Takım Ölçüleri (mm) Dimension (mm) Abmessung (mm)						Kesici Uç Insert Wendescheidplatte	Yedek Parçaları / Spare Parts / Ersatzteile	
		DC	ZEFP	DCON	LF	LH	APMX		Sıkma Vidası Screw Schraube	Tork Anahtar Torx Key Torx-Schlüssel
AEM90-ZC1003-D16-C14-L150-Z02	●	16	2	14	150	25	9			
AEM90-ZC1003-D16-C14-L200-Z02	●	16	2	14	200	25	9			
AEM90-ZC1003-D16-C15-L150-Z02	●	16	2	15	150	25	9			
AEM90-ZC1003-D16-C16-L150-Z02	●	16	2	16	150	25	9			
AEM90-ZC1003-D16-C16-L200-Z02	●	16	2	16	200	50	9			
AEM90-ZC1003-D17-C16-L150-Z02	●	17	2	16	150	25	9			
AEM90-ZC1003-D17-C16-L200-Z02	●	17	2	16	200	25	9			
AEM90-ZC1003-D20-C18-L150-Z03	●	20	3	18	150	25	9			
AEM90-ZC1003-D20-C18-L200-Z02	●	20	2	18	200	25	9			
AEM90-ZC1003-D20-C20-L150-Z03	●	20	3	20	150	40	9			
AEM90-ZC1003-D20-C18-L200-Z03	●	20	3	18	200	25	9			
AEM90-ZC1003-D21-C20-L150-Z02	●	21	2	20	150	30	9			
AEM90-ZC1003-D21-C20-L150-Z03	●	21	3	20	150	30	9			
AEM90-ZC1003-D21-C20-L200-Z03	●	21	3	20	200	30	9			
AEM90-ZC1003-D25-C20-L150-Z03	●	25	3	20	150	30	9			
AEM90-ZC1003-D25-C20-L200-Z03	●	25	3	20	200	30	9			
AEM90-ZC1003-D25-C25-L150-Z03	●	25	3	25	150	40	9			
AEM90-ZC1003-D26-C25-L170-Z03	●	26	3	25	170	25	9			
AEM90-ZC1003-D26-C25-L200-Z03	●	26	3	25	200	25	9			
AEM90-ZC1003-D32-C25-L180-Z04	●	32	4	25	180	30	9			
AEM90-ZC1003-D33-C32-L200-Z04	●	33	4	32	200	25	9			

R: Sağ / Right / Rechts/ L: Sol / Left / Links

● Stokta / In Stock / Auf Lager ○ Stokta Yok / Non Stock Item / Kein Lagerartikel, Lieferzeit auf Anfrage



DJT Ucuna Uygundur. / Compatible with DJT Insert. / Kompatibel mit DJT Wendeplatten.

Sipariş Örneği/Ordering Example/Bestellbeispiel

1 ad./pcs./stück AHFM-EP1003-D050-A22-Z08-H

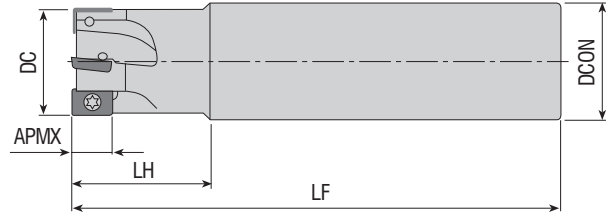
Kesme Hesabı : S 429 / Cutting Calculation : P 429 / Schnittberechnung : P 429



Takım Kodu Ordering Code Bestell-Bezeichnung	Stok Stock Lager	Takım Ölçüleri (mm) Dimension (mm) Abmessung (mm)						Kesici Uç Insert Wendeschneidplatte	Yedek Parçaları / Spare Parts / Ersatzteile	
		DC	ZEFP	DCON	LF	LH	APMX		Sıkma Vidası Screw Schraube	Tork Anahtar Torx Key Torx-Schlüssel
AHFM-E00602-D10-C10-L080-Z02	●	10	2	10	80	20	0.3	 EO.. 0602.. ZOMT 0602..	 3006-M1.8x4	 82-T06
AHFM-E00602-D10-C09-L120-Z02	●	10	2	9	120	15	0.3			
AHFM-E00602-D10-C10-L120-Z02	●	10	2	10	120	60	0.3			
AHFM-E00602-D12-C12-L080-Z02	●	12	2	12	80	20	0.3			
AHFM-E00602-D12-C12-L080-Z03	●	12	3	12	80	20	0.3			
AHFM-E00602-D12-C11-L120-Z02	●	12	2	11	120	15	0.3			
AHFM-E00602-D12-C11-L120-Z03	●	12	3	11	120	15	0.3			
AHFM-E00602-D12-C12-L120-Z02	●	12	2	12	120	60	0.3			
AHFM-E00602-D12-C12-L120-Z03	●	12	3	12	120	60	0.3			
AHFM-E00602-D16-C16-L150-Z04	●	16	4	16	150	60	0.3			

R: Sağ / Right / Rechts/ L: Sol / Left / Links

● Stokta / In Stock / Auf Lager ○ Stokta Yok / Non Stock Item / Kein Lagerartikel, Lieferzeit auf Anfrage

DJT Ucuna Uygun. / Compatible with DJT Insert. / Kompatibel mit DJT Wendeplatten.

Sipariş Örneği/Ordering Example/Bestellbeispiel

1 ad./pcs./stück AHFM-E00602-D10-C10-L080-Z02

Kesme Hesabı : S 429 / Cutting Calculation : P 429 / Schnittberechnung : P 429



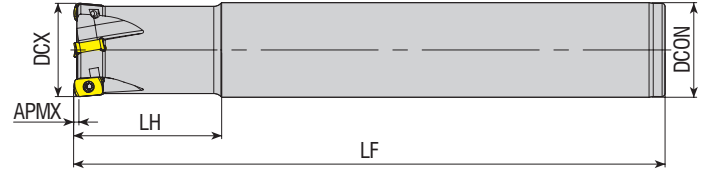

Takım Kodu Ordering Code Bestell-Bezeichnung	Stok Stock Lager	Takım Ölçüleri (mm) Dimension (mm) Abmessung (mm)						Kesici Uç Insert Wendeschneidplatte	Yedek Parçaları / Spare Parts / Ersatzteile		
		DCX	ZEFP	DCON	LF	LH	APMX		Sıkma Vidası Screw Schraube	Tork Anahtar Torx Key Torx-Schlüssel	
AHFM-EN1004-D16-C15-L150-Z02	●	16	2	15	150	25	1	ENMU 1004..	3008-M2.5x6	82-T08	
AHFM-EN1004-D16-C16-L150-Z02	●	16	2	16	150	25	1				
AHFM-EN1004-D16-C16-L250-Z02	●	16	2	16	250	70	1				
AHFM-EN1004-D17-C16-L150-Z02-H	●	17	2	16	150	25	1				
AHFM-EN1004-D17-C16-L150-Z02	●	17	2	16	150	25	1				
AHFM-EN1004-D17-C16-L200-Z02	●	17	2	16	200	25	1				
AHFM-EN1004-D18-C16-L150-Z02	●	18	2	16	150	25	1				
AHFM-EN1004-D20-C20-L150-Z03	●	20	3	20	150	40	1				
AHFM-EN1004-D20-C20-L250-Z03	●	20	3	20	250	70	1				
AHFM-EN1004-D21-C20-L150-Z02	●	21	2	20	150	30	1				
AHFM-EN1004-D21-C20-L150-Z03	●	21	3	20	150	30	1				
AHFM-EN1004-D21-C20-L150-Z03-H	●	21	3	20	150	30	1				
AHFM-EN1004-D21-C20-L200-Z03	●	21	3	20	200	30	1				
AHFM-EN1004-D22-C20-L150-Z03	●	22	3	20	150	30	1				
AHFM-EN1004-D25-C25-L150-Z03	●	25	3	25	150	40	1				
AHFM-EN1004-D25-C25-L150-Z04	●	25	4	25	150	40	1				
AHFM-EN1004-D26-C25-L150-Z03	●	26	3	25	150	30	1				
AHFM-EN1004-D26-C25-L150-Z04	●	26	4	25	150	30	1				
AHFM-EN1004-D26-C25-L200-Z03	●	26	3	25	200	30	1				
AHFM-EN1004-D26-C25-L200-Z03-H	●	26	3	25	200	30	1				
AHFM-EN1004-D26-C25-L250-Z03-H	●	26	3	25	250	30	1				
AHFM-EN1004-D28-C25-L200-Z04	●	28	4	25	200	30	1				
AHFM-EN1004-D32-C32-L200-Z04	●	32	4	32	200	50	1				
AHFM-EN1004-D33-C32-L200-Z04	●	33	4	32	200	30	1				
AHFM-EN1004-D33-C32-L200-Z04-H	●	33	4	32	200	30	1				

R: Sağ / Right / Rechts/ L: Sol / Left / Links

● Stokta / In Stock / Auf Lager ○ Stokta Yok / Non Stock Item / Kein Lagerartikel, Lieferzeit auf Anfrage

DJT Ucuna Uygundur. / Compatible with DJT Insert. / Kompatibel mit DJT Wendeplatten.

Sipariş Örneği/Ordering Example/Bestellbeispiel
1 ad./pcs./stück AHFM-EN1004-D16-C15-L150-Z02

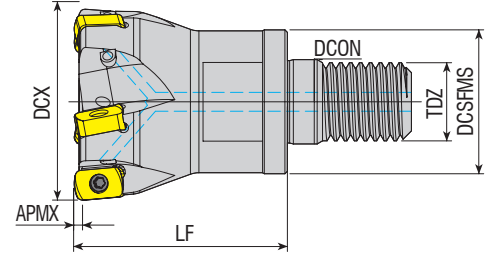

Takım Kodu Ordering Code Bestell-Bezeichnung	Stok Stock Lager	Takım Ölçüleri (mm) Dimension (mm) Abmessung (mm)							Kesici Uç Insert Wendescheidplatte	Yedek Parçaları / Spare Parts / Ersatzteile				
		DCX	ZEFP	DCSFMS	TDZ	LF	DCON	APMX		Sıkma Vidası Screw Schraube	Baskı Parçası Wedge Clamp Spannpratze	Baskı Vidası Clamp Screw Schraube	Tork Anahtar Torx Key Torx-Schlüssel	
AHFM-EN1004-D16-M08-L23-Z02-H	●	16	2	14.75	M08	23	8.5	1	ENMU 1004..	3008-M2.5x6				
AHFM-EN1004-D20-M10-L30-Z03-H	●	20	3	18	M10	30	10.5	1						
AHFM-EN1004-D25-M12-L35-Z03-H	●	25	3	21	M12	35	12.5	1		3008-M2.5x6	-	-	82-T08	
AHFM-EN1004-D25-M12-L35-Z04-H	●	25	4	21	M12	35	12.5	1						
AHFM-EN1004-D32-M16-L43-Z05-H	●	32	5	29	M16	43	17	1						
AHFM-EN1004-D35-M16-L43-Z05-H	●	35	5	29	M16	43	17	1						
AHFM-EN1004-D40-M16-L43-Z05-H	●	40	5	29	M16	43	17	1						
AHFM-EN1004-D42-M16-L43-Z05-H	●	42	5	29	M16	43	17	1						

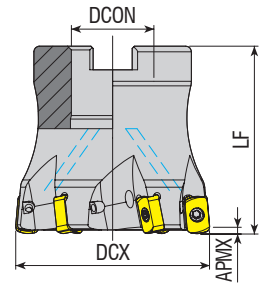

Takım Kodu Ordering Code Bestell-Bezeichnung	Stok Stock Lager	Takım Ölçüleri (mm) Dimension (mm) Abmessung (mm)					Kesici Uç Insert Wendescheidplatte	Yedek Parçaları / Spare Parts / Ersatzteile		
		DCX	ZEFP	DCON	LF	APMX		Sıkma Vidası Screw Schraube	Tork Anahtar Torx Key Torx-Schlüssel	Montaj Vidası Mounting Screw Befestigungsschraube
AHFM-EN1004-D050-A22-Z05-H	●	50	5	22	50	1	ENMU 1004..	3008-M2.5X6	82-T08	2508-M10x30
AHFM-EN1004-D050-A22-Z06-H	●	50	6	22	50	1				
AHFM-EN1004-D052-A22-Z06-H	●	52	6	22	50	1				
AHFM-EN1004-D063-A22-Z06-H	●	63	6	22	50	1				

R: Sağ / Right / Rechts L: Sol / Left / Links

● Stokta / In Stock / Auf Lager ○ Stokta Yok / Non Stock Item / Kein Lagerartikel, Lieferzeit auf Anfrage

DJT Ucuna Uygundur. / Compatible with DJT Insert. / Kompatibel mit DJT Wendeplatten.

Sipariş Örneği/Ordering Example/Bestellbeispiel

1 ad./pcs./stück AHFM-EN1004-D16-M08-L23-Z02-H

Kesme Hesabı : S 429 / Cutting Calculation : P 429 / Schnittberechnung : P 429

Sıkma Tork Değeri : S 428 / Tightening Torque : P 428 / Anzugmoment : P 428

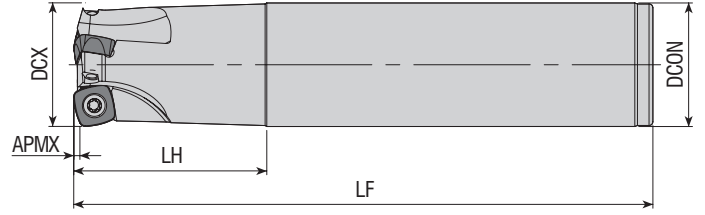

Takım Kodu Ordering Code Bestell-Bezeichnung	Stok Stock Lager	Takım Ölçüleri (mm) Dimension (mm) Abmessung (mm)						Kesici Uç Insert Wendeschneidplatte	Yedek Parçaları / Spare Parts / Ersatzteile		
		DCX	ZEPF	DCON	LF	LH	APMX		Sıkma Vidası Screw Schraube	Baskı Parçası Wedge Clamp Spannpratze	Tork Anahtar Torx Key Torx-Schlüssel
AHFM-SP1004-D25-C25-L150-Z02	●	25	2	25	150	50	1.5	SPNW 1004..	3015-M3.5x9	80-T15	
AHFM-SP1004-D32-C32-L150-Z03	●	32	3	32	150	50	1.5				

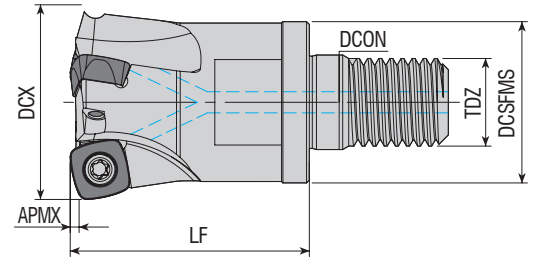

Takım Kodu Ordering Code Bestell-Bezeichnung	Stok Stock Lager	Takım Ölçüleri (mm) Dimension (mm) Abmessung (mm)						Kesici Uç Insert Wendeschneidplatte	Yedek Parçaları / Spare Parts / Ersatzteile				
		DCX	ZEPF	DCSFMS	TDZ	LF	DCON		APMX	Sıkma Vidası Screw Schraube	Baskı Parçası Wedge Clamp Spannpratze	Baskı Vidası Clamp Screw Schraube	Tork Anahtar Torx Key Torx-Schlüssel
AHFM-SP1004-D25-M12-L35-Z02-H	●	25	2	21	M12	35	12.5	1	SPNW 1004..	3015-M3.5x9	-	-	80-T15
AHFM-SP1004-D32-M16-L43-Z03-H	●	32	3	29	M16	43	17	1.5					
AHFM-SP1004-D35-M16-L43-Z03-H	●	35	3	29	M16	43	17	1.5					
AHFM-SP1004-D42-M16-L43-Z04-H	●	42	4	29	M16	43	17	1.5					

R: Sağ / Right / Rechts L: Sol / Left / Links

● Stokta / In Stock / Auf Lager ○ Stokta Yok / Non Stock Item / Kein Lagerartikel, Lieferzeit auf Anfrage

DJT Ucuna Uygundur. / Compatible with DJT Insert. / Kompatibel mit DJT Wendeplatten.

Sipariş Örneği/Ordering Example/Bestellbeispiel

1 ad./pcs./stück AHFM-SP1004-D25-C25-L150-Z02

Kesme Hesabı : S 429 / Cutting Calculation : P 429 / Schnittberechnung : P 429

Montaj Ölçüleri : S 426 / Mounting Reference : P 426 / Montagehinweis : P426

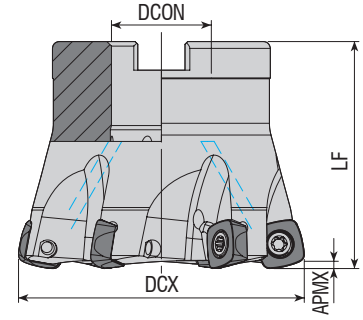

Takım Kodu Ordering Code Bestell-Bezeichnung	Stok Stock Lager	Takım Ölçüleri (mm) Dimension (mm) Abmessung (mm)					Kesici Uç Insert Wendeschneidplatte	Yedek Parçaları / Spare Parts / Ersatzteile		
		DCX	ZEFP	DCON	LF	APMX		Sıkma Vidası Screw Schraube	Tork Anahtar Torx Key Torx-Schlüssel	Montaj Vidası Mounting Screw Befestigungsschraube
AHFM-SP1004-D050-A22-Z05-H	●	50	5	22	50	1.5				
AHFM-SP1004-D052-A22-Z05-H	●	52	5	22	50	1.5				
AHFM-SP1004-D063-A22-Z06-H	●	63	6	22	50	1.5				

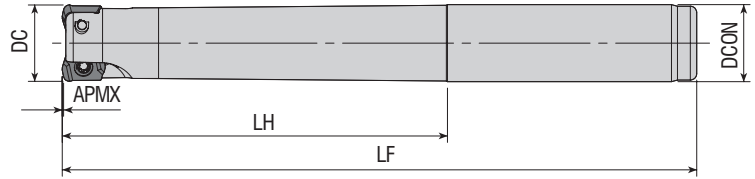

Takım Kodu Ordering Code Bestell-Bezeichnung	Stok Stock Lager	Takım Ölçüleri (mm) Dimension (mm) Abmessung (mm)						Kesici Uç Insert Wendeschneidplatte	Yedek Parçaları / Spare Parts / Ersatzteile	
		DC	ZEFP	DCON	LF	LH	APMX		Sıkma Vidası Screw Schraube	Tork Anahtar Torx Key Torx-Schlüssel
AHFM-YO0602-D10-C09-L120-Z02-F	●	10	2	9	120	15	0.3			
AHFM-YO0602-D10-C10-L080-Z02-F	●	10	2	10	80	20	0.3			
AHFM-YO0602-D10-C10-L120-Z02-F	●	10	2	10	120	60	0.3			
AHFM-YO0602-D10-C10-L120-Z02-H-F	●	10	2	10	120	60	0.3			
AHFM-YO0602-D10-C10-L120-Z02-H	●	10	2	10	120	60	0.3			
AHFM-YO0602-D12-C11-L120-Z02-F	●	12	2	11	120	15	0.3			
AHFM-YO0602-D12-C11-L120-Z02-H-F	●	12	2	11	120	15	0.3			
AHFM-YO0602-D12-C11-L120-Z02-H	●	12	2	11	120	15	0.3			
AHFM-YO0602-D12-C11-L120-Z03-F	●	12	3	11	120	15	0.3			
AHFM-YO0602-D12-C12-L080-Z02-F	●	12	2	12	80	20	0.3			
AHFM-YO0602-D12-C12-L080-Z03-F	●	12	3	12	80	20	0.3			
AHFM-YO0602-D12-C12-L120-Z02-F	●	12	2	12	120	60	0.3			
AHFM-YO0602-D12-C12-L120-Z02-H	●	12	2	12	120	60	0.3			
AHFM-YO0602-D12-C12-L120-Z03-F	●	12	3	12	120	60	0.3			
AHFM-YO0602-D12-C12-L120-Z03-H	●	12	3	12	120	60	0.3			

R: Sağ / Right / Rechts / L: Sol / Left / Links

● Stokta / In Stock / Auf Lager ○ Stokta Yok / Non Stock Item / Kein Lagerartikel, Lieferzeit auf Anfrage

DJT Ucuna Uygunudur. / Compatible with DJT Insert. / Kompatibel mit DJT Wendeplatten.

F: Eksenel ve Radyal Salgı Değeri 0,02 mm içindedir. / F: Axial and radial runout value is within 0,02mm / F: Der axiale und radiale Rundlaufwert liegt innerhalb von 0,02 mm.

Sipariş Örneği/Ordering Example/Bestellbeispiel
1 ad./pcs./stück AHFM-SP1004-D050-A22-Z05-H

Kesme Hesabı : S 429 / Cutting Calculation : P 429 / Schnittberechnung : P 429

Montaj Ölçüleri : S 426 / Mounting Reference : P 426 / Montagehinweis : P 426

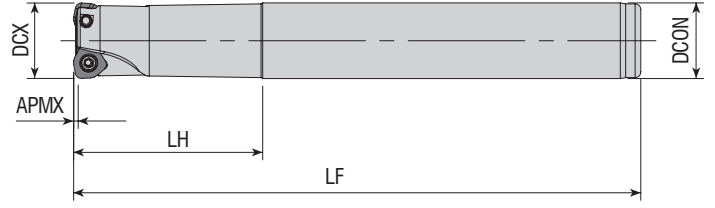

Takım Kodu Ordering Code Bestell-Bezeichnung	Stok Stock Lager	Takım Ölçüleri (mm) Dimension (mm) Abmessung (mm)						Kesici Uç Insert Wendeschneidplatte	Yedek Parçaları / Spare Parts / Ersatzteile				
		DCX	ZEFP	DCON	LF	LH	APMX		Sıkma Vidası Screw Schraube	Baskı Parçası Wedge Clamp Spannpratze	Baskı Vidası Clamp Screw Schraube	Tork Anahtar Torx Key Torx-Schlüssel	
AHFM-WD0503D-D20-C20-L150-Z02	●	20	2	20	150	50	1.25	WD.W 0503..	4010-M3x6	-	-	82-T10	
AHFM-WD0503D-D21-C20-L150-Z02	●	21	2	20	150	30	1.25						
AHFMC-WD06T3D-D26-C25-L200-Z02	●	26	2	25	200	30	1.5	WD.W 06T3..	3015-M3.5x9	ACK-15	4015-M3.5x11	80-T15	
AHFMC-WD06T3D-D33-C32-L200-Z03	●	33	3	32	200	32	1.5						

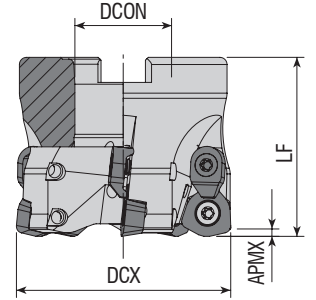

Takım Kodu Ordering Code Bestell-Bezeichnung	Stok Stock Lager	Takım Ölçüleri (mm) Dimension (mm) Abmessung (mm)					Kesici Uç Insert Wendeschneidplatte	Yedek Parçaları / Spare Parts / Ersatzteile				
		DCX	ZEFP	DCON	LF	APMX		Sıkma Vidası Screw Schraube	Baskı Pabucu Wedge Clamp Spannpratze	Baskı Vidası Clamp Screw Klemmschraube	Tork Anahtar Torx Key Torx-Schlüssel	Montaj Vidası Mounting Screw Befestigungsschraube
AHFMC-WD06T3D-D042-A16-Z04-H	●	42	4	16	45	1.5	WD.W 06T3..	3015-M3.5x9	ACK-15	4015-M3.5x11	80-T15	2506-M8x30
AHFMC-WD06T3D-D050-A22-Z05-H	●	50	5	22	50	1.5						
AHFMC-WD06T3D-D052-A22-Z05-H	●	52	5	22	50	1.5						
AHFMC-WD06T3D-D063-A22-Z06-H	●	63	6	22	50	1.5						
AHFMC-WD0805D-D052-A22-Z04-H	●	52	4	22	50	2	WD.W 0805..	4020-M4.5x12	ACK-19	4020-M4.5x12	80-T20	2508-M10x30
AHFMC-WD0805D-D063-A22-Z05-H	●	63	5	22	50	2						
AHFMC-WD0805D-D063-A27-Z05-H	●	63	5	27	50	2						
AHFMC-WD0805D-D066-A27-Z05-H	●	66	5	27	50	2						
AHFMC-WD0805D-D080-A27-Z05	●	80	5	27	50	2	WD.W 10X6..	-	-	-	-	
AHFMC-WD0805D-D100-A32-Z06	●	100	6	32	50	2						
AHFMC-WD10X6D-D125-B40-Z06	●	125	6	40	63	2.5						
AHFMC-WD10X6D-D160-C40-Z07	●	160	7	40	63	2.5						

R: Sağ / Right / Rechts L: Sol / Left / Links

● Stokta / In Stock / Auf Lager ○ Stokta Yok / Non Stock Item / Kein Lagerartikel, Lieferzeit auf Anfrage

DJT Ucuna Uygundur. / Compatible with DJT Insert. / Kompatibel mit DJT Wendeplatten.

Sipariş Örneği/Ordering Example/Bestellbeispiel

1 ad./pcs./stück AHFM-WD0503D-D20-C20-L150-Z02

Kesme Hesabı : S 429 / Cutting Calculation : P 429 / Schnittberechnung : P 429

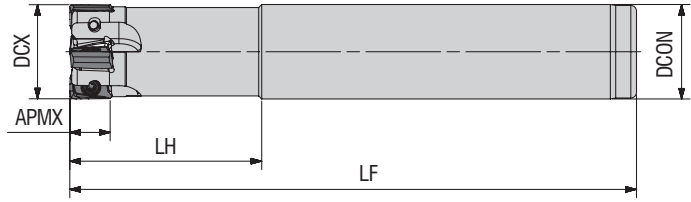

Takım Kodu Ordering Code Bestell-Bezeichnung	Stok Stock Lager	Takım Ölçüleri (mm) Dimension (mm) Abmessung (mm)						Kesici Uç Insert Wendeschneidplatte	Yedek Parçaları / Spare Parts / Ersatzteile			
		DCX	ZEFP	DCON	LF	LH	APMX		Sıkma Vidası Screw Schraube	Baskı Parçası Wedge Clamp Spannpratze	Baskı Vidası Clamp Screw Schraube	Tork Anahtar Torx Key Torx-Schlüssel
AHFM-ZN11-D21-C20-L150-Z03	●	21	3	20	150	30	-	ZN.. 1105..	4010-M3x8	-	-	82-T08
AHFM-ZN11-D21-C20-L200-Z03	●	21	3	20	200	30	-					
AHFM-ZN11-D25-C25-L150-Z04	●	25	4	25	150	50	-					

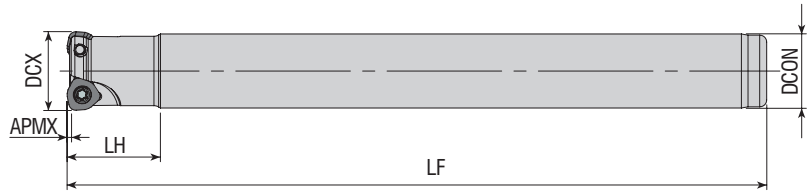

Takım Kodu Ordering Code Bestell-Bezeichnung	Stok Stock Lager	Takım Ölçüleri (mm) Dimension (mm) Abmessung (mm)						Kesici Uç Insert Wendeschneidplatte	Yedek Parçaları / Spare Parts / Ersatzteile		
		DCX	ZEFP	DCON	LF	LH	APMX		Sıkma Vidası Screw Schraube	Tork Anahtar Torx Key Torx-Schlüssel	
AHFM-W004T2D-D16-C16-L150-Z02	●	16	2	16	150	20	0.8	WOMW 04T2..	3008-M2.5x6	82-T08	
AHFM-W004T2D-D17-C16-L150-Z02	●	17	2	16	150	20	0.8				

R: Sağ / Right / Rechts/ L: Sol / Left / Links

● Stokta / In Stock / Auf Lager ○ Stokta Yok / Non Stock Item / Kein Lagerartikel, Lieferzeit auf Anfrage

DJT Ucuna Uygunur. / Compatible with DJT Insert. / Kompatibel mit DJT Wendeplatten.

Sipariş Örneği/Ordering Example/Bestellbeispiel

1 ad./pcs./stück AHFM-ZN11-D21-C20-L150-Z03

Kesme Hesabı : S 429 / Cutting Calculation : P 429 / Schnittberechnung : P 429

Sıkma Tork Değeri : S 428 / Tightening Torque : P 428 / Anzugsmoment : P 428



KAPR=90°

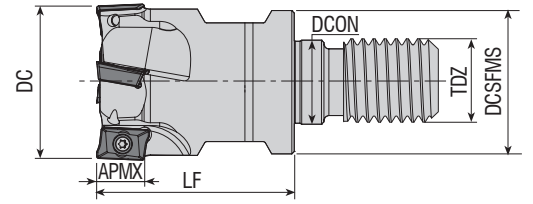

Takım Kodu Ordering Code Bestell-Bezeichnung	Stok Stock Lager	Takım Ölçüleri (mm) Dimension (mm) Abmessung (mm)							Kesici Uç Insert Wendeschneidplatte	Yedek Parçaları / Spare Parts / Ersatzteile		
		DC	ZEFP	DCSFMS	TDZ	LF	DCON	APMX		Sıkma Vidası Screw Schraube	Tork Anahtar Torx Key Torx-Schlüssel	
AEM90-AD1505D-D25-M12-L43-Z02-H	●	25	2	21	M12	43	12.5	14.3	ADKT 150508	4015-M4x9 4015-M4x11	80-T15	
AEM90-AD1505D-D32-M16-L43-Z03-H	●	32	3	29	M16	43	17	14.3				

KAPR=90°

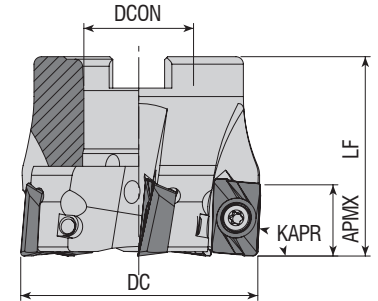

Takım Kodu Ordering Code Bestell-Bezeichnung	Stok Stock Lager	Takım Ölçüleri (mm) Dimension (mm) Abmessung (mm)						Kesici Uç Insert Wendeschneidplatte	Yedek Parçaları / Spare Parts / Ersatzteile			
		DC	ZEFP	DCON	LF	APMX	Sıkma Vidası Screw Schraube		Tork Anahtar Torx Key Torx-Schlüssel	Montaj Vidası Mounting Screw Befestigungsschraube		
AFM90-AD1505D-D050-A22-Z05-H	●	50	5	22	40	14.3	ADKT 150508	4015-M4x11	80-T15	2508-M10x30		
AFM90-AD1505D-D063-A27-Z06-H	●	63	6	27	50	14.3				2510-M12x35		
AFM90-AD1505D-D080-A27-Z08-H	●	80	8	27	50	14.3				2514-M16x35		
AFM90-AD1505D-D100-A32-Z08-H	●	100	8	32	50	14.3				-		
AFM90-AD1505D-D125-B40-Z09	●	125	9	40	63	14.3				-		

R: Sağ / Right / Rechts/ L: Sol / Left / Links

● Stokta / In Stock / Auf Lager ○ Stokta Yok / Non Stock Item / Kein Lagerartikel, Lieferzeit auf Anfrage

DJT Ucuna Uygundur. / Compatible with DJT Insert. / Kompatibel mit DJT Wendeplatten.

Sipariş Örneği/Ordering Example/Bestellbeispiel

1 ad./pcs./stück AEM90-AD1505D-D25-M12-L43-Z02-H

Kesme Hesabı : S 429 / Cutting Calculation : P 429 / Schnittberechnung : P 429

Sıkma Tork Değeri : S 428 / Tightening Torque : P 428 / Anzugmoment : P 428

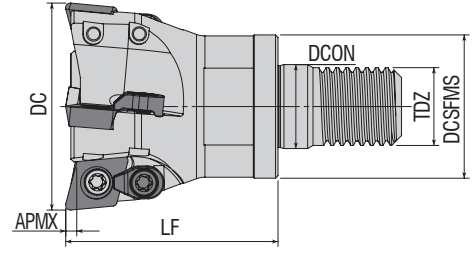
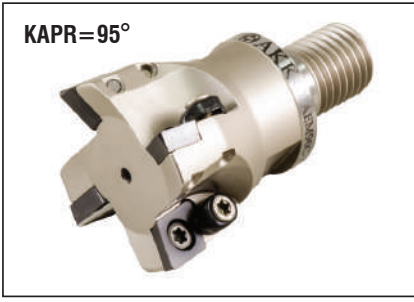

Takım Kodu Ordering Code Bestell-Bezeichnung	Stok Stock Lager	Takım Ölçüleri (mm) Dimension (mm) Abmessung (mm)						Kesici Uç Insert Wendeschneidplatte	Yedek Parçaları / Spare Parts / Ersatzteile				
		DC	ZEP	DCSFMS	TDZ	LF	DCON		APMX	Sıkma Vidası Screw Schraube	Baskı Parçası Wedge Clamp Spannpratze	Baskı Vidası Clamp Screw Schraube	Tork Anahtar Torx Key Torx-Schlüssel
AEM95-XD0206-D16-M08-L23-Z02-H	●	16	2	14.75	M08	23	8.5	1	XDHW 0206..	3008-M2.5x5	-	-	82-T08
AEM95-XD0206-D16-M08-L23-Z02-H-F	●	16	2	14.75	M08	23	8.5	1					
AEM95-XD0206-D20-M10-L30-Z03-H	●	20	3	18	M10	30	10.5	1					
AEM95-XD0206-D20-M10-L30-Z03-H-F	●	20	3	18	M10	30	10.5	1					
AEM95-XD0206-D25-M12-L35-Z03-H	●	25	3	21	M12	35	12.5	1					
AEM95-XD0206-D25-M12-L35-Z03-H-F	●	25	3	21	M12	35	12.5	1					
AEM95C-XD0310-D35-M16-L43-Z03-H	●	35	3	29	M16	43	17	1.5	XDHW 0310..	4015-M3.5x9	ACK-15	4015-M3.5x11	80-T15
AEM95C-XD0310-D35-M16-L43-Z03-H-F	●	35	3	29	M16	43	17	1.5					
AEM95C-XD0310-D42-M16-L43-Z04-H	●	42	4	29	M16	43	17	1.5					
AEM95C-XD0310-D42-M16-L43-Z04-H-F	●	42	4	29	M16	43	17	1.5					

Çap Ölçüsü - 0,02 mm Olarak üretiliyor. F: ± 0,02 mm Demektir. Ör: Ø16 Takım 15,98 ± 0,02 mm yani 16,00 mm - 15,96 mm Olmalıdır.
Diameter Size is produced as - 0,02 mm. F: means ± 0,02 mm. For example: Ø16 tool 15,98 ± 0,02 mm, it means that it should be 16,00 mm - 15,96 mm.
Durchmesser - Es wird mit -0,02 mm hergestellt. Das heißt F: ± 0,02 mm. Zum Beispiel: Der Ø16-Satz sollte 15,98 ± 0,02 mm, 16,00 mm - 15,96 mm betragen.

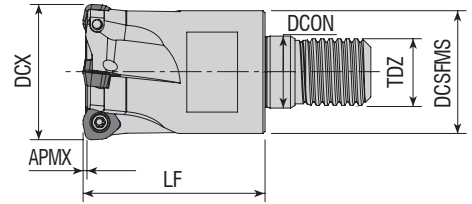



Takım Kodu Ordering Code Bestell-Bezeichnung	Stok Stock Lager	Takım Ölçüleri (mm) Dimension (mm) Abmessung (mm)						Kesici Uç Insert Wendeschneidplatte	Yedek Parçaları / Spare Parts / Ersatzteile				
		DCX	ZEP	DCSFMS	TDZ	LF	DCON		APMX	Sıkma Vidası Screw Schraube	Baskı Parçası Wedge Clamp Spannpratze	Baskı Vidası Clamp Screw Schraube	Tork Anahtar Torx Key Torx-Schlüssel
AHFM-WD0503D-D20-M10-L30-Z02-H	●	20	2	18	M10	30	10.5	1.25	WDMT 0503..	4010-M3x6	-	-	82-T10
AHFM-WD0503D-D25-M12-L35-Z03-H	●	25	3	21	M12	35	12.5	1.25					
AHFM-WD0503D-D32-M16-L43-Z04-H	●	32	4	29	M16	43	17	1.25					
AHFM-WD0503D-D40-M16-L43-Z05-H	●	40	5	29	M16	43	17	1.25					
AHFMC-WD06T3D-D35-M16-L43-Z03-H	●	35	3	29	M16	43	17	1.5	WDHW 06T3..	3015-M3.5x9	ACK-15	4015-M3.5x11	80-T15
AHFMC-WD0805D-D32-M16-L43-Z02-H	●	32	2	29	M16	43	17	2	WDHW 0805..	4020-M4.5x10	ACK-19	4020-M4.5x12	

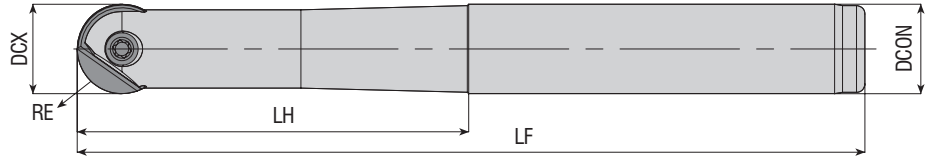

R: Sağ / Right / Rechts L: Sol / Left / Links
● Stokta / In Stock / Auf Lager ○ Stokta Yok / Non Stock Item / Kein Lagerartikel, Lieferzeit auf Anfrage
DJT Ucuna Uygun. / Compatible with DJT Insert. / Kompatibel mit DJT Wendeplatten.

Sipariş Örneği/Ordering Example/Bestellbeispiel
1 ad./pcs./stück AEM95-XD0206-D16-M08-L23-Z02-H
Kesme Hesabı : S 429 / Cutting Calculation : P 429 / Schnittberechnung : P 429
Sıkma Tork Değeri : S 428 / Tightening Torque : P 428 / Anzugsmoment : P 428

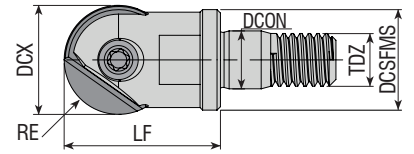

Takım Kodu Ordering Code Bestell-Bezeichnung	Stok Stock Lager	Takım Ölçüleri (mm) Dimension (mm) Abmessung (mm)					Kesici Uç Insert Wendeschneidplatte	Yedek Parçaları / Spare Parts / Ersatzteile	
		DCX	RE	DCON	LF	LH		Sıkma Vidası Screw Schraube	Tork Anahtar Torx Key Torx-Schlüssel
APMR-BNM12-D12-C12-L130	●	12	6	12	130	32			
APMR-BNM16-D16-C16-L175	●	16	8	16	175	70	BNN 160-S	1215-M4x13.5	80-T15
APMR-BNM16-D16-C16-L200	●	16	8	16	200	100	BNN 200-S	1220-M5x0.5x15	80-T20
APMR-BNM20-D20-C20-L160	●	20	10	20	160	70			
APMR-BNM20-D20-C20-L200	●	20	10	20	200	100			
APMR-BNM20-D20-C20-L250	●	20	10	20	250	150	BNN 250-S	1220-M6x0.75x20	80-T20
APMR-BNM25-D25-C25-L160	●	25	12.5	25	160	70			
APMR-BNM25-D25-C25-L200	●	25	12.5	25	200	100			
APMR-BNM25-D25-C25-L250	●	25	12.5	25	250	150			

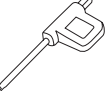

Takım Kodu Ordering Code Bestell-Bezeichnung	Stok Stock Lager	Takım Ölçüleri (mm) Dimension (mm) Abmessung (mm)						Kesici Uç Insert Wendeschneidplatte	Yedek Parçaları / Spare Parts / Ersatzteile	
		DCX	RE	DCSFMS	TDZ	LF	DCON		Sıkma Vidası Screw Schraube	Tork Anahtar Torx Key Torx-Schlüssel
APMR-BNM12-D12-M06-L20	●	12	6	11	M06	20	6.5			
APMR-BNM16-D16-M08-L23	●	16	8	14.75	M08	23	8.5	BNN 160-S	1215-M4x13.5	80-T15
APMR-BNM20-D20-M10-L30	●	20	10	18	M10	30	10.5	BNN 200-S	1220-M5x0.5x15	80-T20

R: Sağ / Right / Rechts L: Sol / Left / Links

● Stokta / In Stock / Auf Lager ○ Stokta Yok / Non Stock Item / Kein Lagerartikel, Lieferzeit auf Anfrage

DJT Ucuna Uygunudur. / Compatible with DJT Insert. / Kompatibel mit DJT Wendeplatten.





Sipariş Örneği/Ordering Example/Bestellbeispiel

1 ad./pcs./stück APMR-BNM12-D12-C12-L130

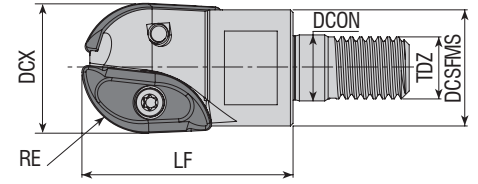

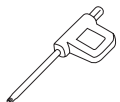
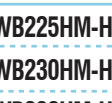

Kesme Hesabı : S 429 / Cutting Calculation : P 429 / Schnittberechnung : P 429

Sıkma Tork Değeri : S 428 / Tightening Torque : P 428 / Anzugmoment : P 428

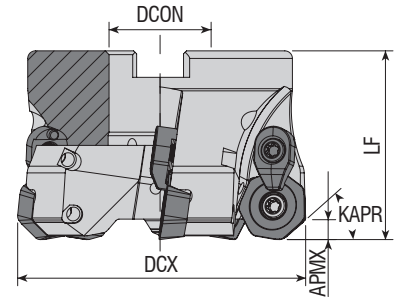

Takım Kodu Ordering Code Bestell-Bezeichnung	Stok Stock Lager	Takım Ölçüleri (mm) Dimension (mm) Abmessung (mm)						Kesici Uç Insert Wendeschneidplatte	Yedek Parçaları / Spare Parts / Ersatzteile		
		DCX	RE	DCSFMS	TDZ	LF	DCON		Sıkma Vidası Screw Schraube	Tork Anahtar Torx Key Torx-Schlüssel	
APMR-SWB225-D25-M12-L35	●	25	12.5	23.5	M12	35	12.5				
APMR-SWB230-D30-M16-L43	●	30	15	28	M16	43	17		1020-M5x11	80-T20	
APMR-SWB232-D32-M16-L43	●	32	16	30	M16	43	17				



Takım Kodu Ordering Code Bestell-Bezeichnung	Stok Stock Lager	Takım Ölçüleri (mm) Dimension (mm) Abmessung (mm)					Kesici Uç Insert Wendeschneidplatte	Yedek Parçaları / Spare Parts / Ersatzteile				
		DCX	ZEFP	DCON	LF	APMX		Sıkma Vidası Screw Schraube	Baskı Parçası Wedge Clamp Spannpratze	Baskı Vidası Clamp Screw Klemmschraube	Tork Anahtar Torx Key Torx-Schlüssel	Montaj Vidası Mounting Screw Befestigungsschraube
AFM42C-XD0806-D063-A27-Z04-H	●	63	4	27	50	12				4020-M4.5x12	80-T20	
AFM42C-XD0806-D080-A27-Z05-H	●	80	5	27	50	12						
AFM42C-XD0806-D100-A32-Z06-H	●	100	6	32	63	12						
AFM42C-XD0806-D125-B40-Z07	●	125	7	40	63	12						
AFM42C-XD0806-D160-C40-Z08	●	160	8	40	63	12						
AFM42C-XD0806-D200-C60-Z09	●	200	9	60	63	12						

R: Sağ / Right / Rechts | L: Sol / Left / Links

● Stokta / In Stock / Auf Lager ○ Stokta Yok / Non Stock Item / Kein Lagerartikel, Lieferzeit auf Anfrage

DJT Ucuna Uygun. / Compatible with DJT Insert. / Kompatibel mit DJT Wendeplatten.

Sipariş Örneği/Ordering Example/Bestellbeispiel

1 ad./pcs./stück APMR-SWB225-D25-M12-L35

Kesme Hesabı : S 429 / Cutting Calculation : P 429 / Schnittberechnung : P 429

Sıkma Tork Değeri : S 428 / Tightening Torque : P 428 / Anzugsmoment : P 428

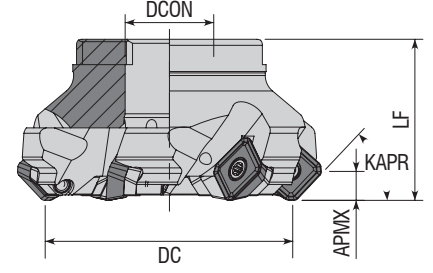

Takım Kodu Ordering Code Bestell-Bezeichnung	Stok Stock Lager	Takım Ölçüleri (mm) Dimension (mm) Abmessung (mm)					Kesici Uç Insert Wendeschneidplatte	Yedek Parçaları / Spare Parts / Ersatzteile				
		DC	ZEFP	DCON	LF	APMX		Altılık Screw Unterlage	Altılık Vidası Wedge Clamp Винт опорной пластины	Sıkma Vidası Screw Schraube	Tork Anahtar Torx Key Torx-Schlüssel	Montaj Vidası Mounting Screw Befestigungsschraube
AFM45-SE13-D050-A22-Z04-H	●	50	4	22	40	6	SEMT 13T3..	AASE-3-0001	AAV-16-M3.5x8	4015-M3.5x11	80-T15	2407-M10x30
AFM45-SE13-D063-A22-Z05-H	●	63	5	22	40	6						
AFM45-SE13-D080-A27-Z06-H	●	80	6	27	50	6						
AFM45S-SE13-D050-A22-Z05-H	●	50	5	22	40	6						
AFM45S-SE13-D063-A22-Z06-H	●	63	6	22	40	6						
AFM45S-SE13-D080-A27-Z08-H	●	80	8	27	50	6						
AFM45S-SE13-D100-A32-Z10-H	●	100	10	32	50	6						
AFM45S-SE13-D125-B40-Z12	●	125	12	40	63	6						

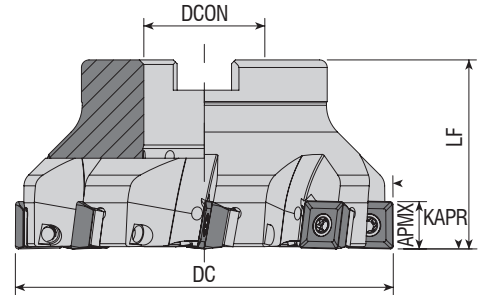

Takım Kodu Ordering Code Bestell-Bezeichnung	Stok Stock Lager	Takım Ölçüleri (mm) Dimension (mm) Abmessung (mm)					Kesici Uç Insert Wendeschneidplatte	Yedek Parçaları / Spare Parts / Ersatzteile				
		DC	ZEFP	DCON	LF	APMX		Altılık Screw Unterlage	Baskı Parçası Wedge Clamp Spannpratze	Sıkma Vidası Screw Schraube	Tork Anahtar Torx Key Torx-Schlüssel	Montaj Vidası Mounting Screw Befestigungsschraube
AFM90S-SD1204-D050-A22-Z04-H	●	50	4	22	40	11	SDMT 1204..	AASD-3-0001	AAV-08-M3.5x8	4015-M3.5x12	80-T15	2408-M10x30
AFM90S-SD1204-D063-A22-Z05-H	●	63	5	22	40	11						2508-M10x30
AFM90S-SD1204-D080-A27-Z06-H	●	80	6	27	50	11						2510-M12x35
AFM90S-SD1204-D100-A32-Z08-H	●	100	8	32	50	11						2514-M16x35
AFM90S-SD1204-D125-B40-Z10	●	125	10	40	63	11						-
AFM90S-SD1204-D160-C40-Z12	●	160	12	40	63	11						-

R: Sağ / Right / Rechts/ L: Sol / Left / Links

● Stokta / In Stock / Auf Lager ○ Stokta Yok / Non Stock Item / Kein Lagerartikel, Lieferzeit auf Anfrage

DJT Ucuna Uygundur. / Compatible with DJT Insert. / Kompatibel mit DJT Wendeplatten.

Sipariş Örneği/Ordering Example/Bestellbeispiel

1 ad./pcs./stück AFM45-SE13-D050-A22-Z04-H

Kesme Hesabı : S 429 / Cutting Calculation : P 429 / Schnittberechnung : P 429

Sıkma Tork Değeri : S 428 / Tightening Torque : P 428 / Anzugsmoment : P 428

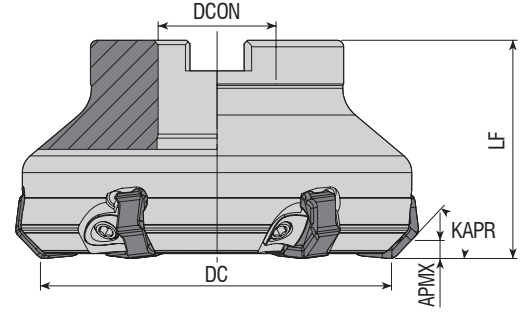

Takım Kodu Ordering Code Bestell-Bezeichnung	Stok Stock Lager	Takım Ölçüleri (mm) Dimension (mm) Abmessung (mm)					Kesici Uç Insert Wendeschneidplatte	Yedek Parçaları / Spare Parts / Ersatzteile			
		DC	ZEFP	DCON	LF	APMX		Baskı Parçası Wedge Clamp Spannpratze	Baskı Vidası Clamp Screw Klemmschraube	Anahtar Allen Key Innensechskantschlüssel	Montaj Vidası Mounting Screw Befestigungsschraube
AFM45C-XN0806-D063-A22-Z05	●	63	5	22	50	4.5	XNMU 0806..	ACK-26	AKV-26-M6x0.75x20	AAL-03-03	2508-M10x30
AFM45C-XN0806-D080-A27-Z06	●	80	6	27	50	4.5					2510-M12x35
AFM45C-XN0806-D100-A32-Z08	●	100	8	32	50	4.5					2514-M16x35
AFM45C-XN0806-D125-B40-Z08	●	125	8	40	63	4.5					-
AFM45C-XN0806-D160-C40-Z10	●	160	10	40	63	4.5					-
AFM45C-XN0806-D200-C60-Z12	●	200	12	60	63	4.5					-

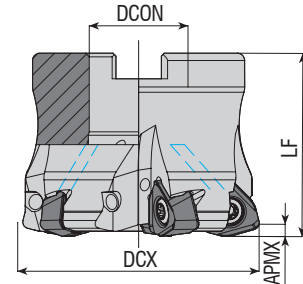

Takım Kodu Ordering Code Bestell-Bezeichnung	Stok Stock Lager	Takım Ölçüleri (mm) Dimension (mm) Abmessung (mm)					Kesici Uç Insert Wendeschneidplatte	Yedek Parçaları / Spare Parts / Ersatzteile		
		DCX	ZEFP	DCON	LF	APMX		Sıkma Vidası Screw Schraube	Tork Anahtar Torx Key Torx-Schlüssel	Montaj Vidası Mounting Screw Befestigungsschraube
AHFM-WN0706-D050-A22-Z05-H	●	50	5	22	50	2	WNMU 0706..	4015-M4x11	80-T15	2508-M10x30
AHFM-WN0706-D063-A22-Z06-H	●	63	6	22	50	2				2510-M12x35
AHFM-WN0907-D050-A22-Z04-H	●	50	4	22	50	3	WNMU 0907..	1020-M5x14	80-T20	2514-M16x35
AHFM-WN0907-D052-A22-Z04-H	●	52	4	22	50	3				-
AHFM-WN0907-D063-A22-Z05-H	●	63	5	22	50	3				-
AHFM-WN0907-D066-A27-Z05-H	●	66	5	27	50	3				-
AHFM-WN0907-D080-A27-Z06-H	●	80	6	27	50	3				-
AHFM-WN0907-D100-A32-Z07-H	●	100	7	32	50	3	-			

R: Sağ / Right / Rechts/ L: Sol / Left / Links

● Stokta / In Stock / Auf Lager ○ Stokta Yok / Non Stock Item / Kein Lagerartikel, Lieferzeit auf Anfrage

DJT Ucuna Uygundur. / Compatible with DJT Insert. / Kompatibel mit DJT Wendeplatten.

Sipariş Örneği/Ordering Example/Bestellbeispiel

1 ad./pcs./stück AFM45C-XN0806-D063-A22-Z05

Kesme Hesabı : S 429 / Cutting Calculation : P 429 / Schnittberechnung : P 429

Montaj Ölçüleri : S 426 / Mounting Reference : P 426 / Montagehinweis : P426

HTCH Ucuna Uygunudur. / Compatible with HTCH Insert. / Kompatibel mit HTCH Wendeplatten.

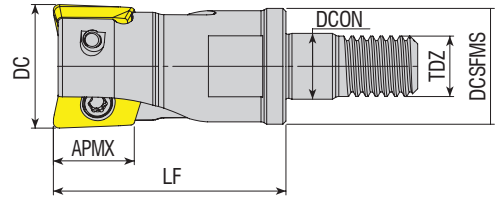

Takım Kodu Ordering Code Bestell-Bezeichnung	Stok Stock Lager	Takım Ölçüleri (mm) Dimension (mm) Abmessung (mm)							Kesici Uç Insert Wendeschneidplatte	Yedek Parçaları / Spare Parts / Ersatzteile		
		DC	ZEFP	DCSFMS	TDZ	LF	DCON	APMX		Sıkma Vidası Screw Schraube	Tork Anahtar Torx Key Torx-Schlüssel	
AHFM-JD1003-D16-M08-L30-Z02-H	●	16	2	14.75	M08	30	8.5	9	JDMT 1003..	3008-M2.5x6	82-T08	
AHFM-JD1003-D20-M10-L30-Z03-H	●	20	3	18	M10	30	10.5	9				

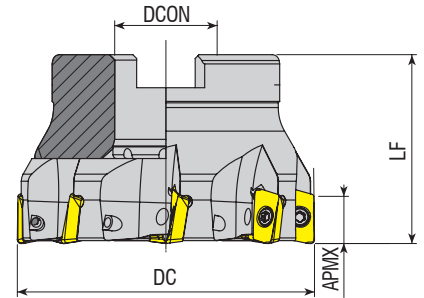

Takım Kodu Ordering Code Bestell-Bezeichnung	Stok Stock Lager	Takım Ölçüleri (mm) Dimension (mm) Abmessung (mm)					Kesici Uç Insert Wendeschneidplatte	Yedek Parçaları / Spare Parts / Ersatzteile			
		DC	ZEFP	DCON	LF	APMX		Sıkma Vidası Screw Schraube	Tork Anahtar Torx Key Torx-Schlüssel	Montaj Vidası Mounting Screw Befestigungsschraube	
AHFM-JD1003-D040-A16-Z06-H	●	40	6	16	40	9	JDMT 1003..	3008-M2.5x6	82-T08	2506-M8x30	
AHFM-JD1003-D063-A22-Z08-H	●	63	8	22	40	9				2508-M10x30	

R: Sağ / Right / Rechts/ L: Sol / Left / Links

● Stokta / In Stock / Auf Lager ○ Stokta Yok / Non Stock Item / Kein Lagerartikel, Lieferzeit auf Anfrage

HTCH Ucuna Uygunudur. / Compatible with HTCH Insert. / Kompatibel mit HTCH Wendeplatten.

Sipariş Örneği/Ordering Example/Bestellbeispiel

1 ad./pcs./stück AHFM-JD1003-D16-M08-L30-Z02-H

Kesme Hesabı : S 429 / Cutting Calculation : P 429 / Schnittberechnung : P 429

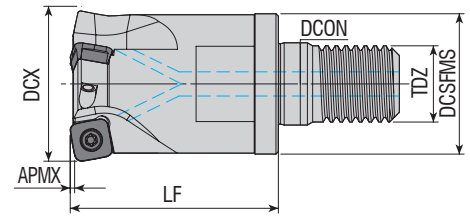

Takım Kodu Ordering Code Bestell-Bezeichnung	Stok Stock Lager	Takım Ölçüleri (mm) Dimension (mm) Abmessung (mm)							Kesici Uç Insert Wendeschneidplatte	Yedek Parçaları / Spare Parts / Ersatzteile		
		DCX	ZEP	DCSFMS	TDZ	LF	DCON	APMX		Sıkma Vidası Screw Schraube	Tork Anahtar Torx Key Torx-Schlüssel	
AHFM-SD1205-D32-M16-L40-Z03-H	●	32	3	29	M16	40	17	2	SD.. 1205..	4015-M4x11	80-T15	
AHFM-SD1205-D35-M16-L40-Z03-H	●	35	3	29	M16	40	17	2				
AHFM-SD1205-D40-M16-L43-Z03-H	●	40	3	29	M16	43	17	2				
AHFM-SD1205-D42-M16-L43-Z03-H	●	42	3	29	M16	43	17	2				

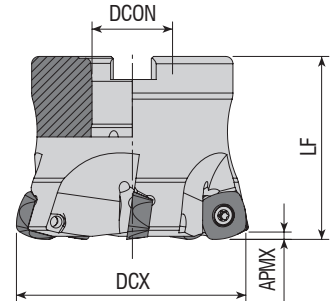

Takım Kodu Ordering Code Bestell-Bezeichnung	Stok Stock Lager	Takım Ölçüleri (mm) Dimension (mm) Abmessung (mm)					Kesici Uç Insert Wendeschneidplatte	Yedek Parçaları / Spare Parts / Ersatzteile			
		DCX	ZEP	DCON	LF	APMX		Sıkma Vidası Screw Schraube	Tork Anahtar Torx Key Torx-Schlüssel	Montaj Vidası Mounting Screw Befestigungsschraube	
AHFM-SD1205-D052-A22-Z04-H	●	52	4	22	50	2	SD.. 1205..	4015-M4x11	80-T15	2508-M10x30	
AHFM-SD1205-D052-A22-Z05-H	●	52	5	22	50	2					
AHFM-SD1205-D063-A22-Z05-H	●	63	5	22	50	2					
AHFM-SD1205-D066-A22-Z05-H	●	66	5	22	50	2					
AHFM-SD1205-D066-A22-Z06-H	●	66	6	22	50	2					
AHFM-SD1205-D080-A27-Z06-H	●	80	6	27	70	2					
new AHFM-SD1205-D100-A32-Z08-H	●	100	8	32	70	2				2510-M12x35	2514-M16x35

R: Sağ / Right / Rechts/ L: Sol / Left / Links

● Stokta / In Stock / Auf Lager ○ Stokta Yok / Non Stock Item / Kein Lagerartikel, Lieferzeit auf Anfrage

HTCH Ucuna Uygundur. / Compatible with HTCH Insert. / Kompatibel mit HTCH Wendeplatten.

Sipariş Örneği/Ordering Example/Bestellbeispiel

1 ad./pcs./stück AHFM-SD1205-D32-M16-L40-Z03-H

Kesme Hesabı : S 429 / Cutting Calculation : P 429 / Schnittberechnung : P 429

Montaj Ölçüleri : S 426 / Mounting Reference : P 426 / Montagehinweis : P 426

HTCH Ucuna Uygunur. / Compatible with HTCH Insert. / Kompatibel mit HTCH Wendeplatten.

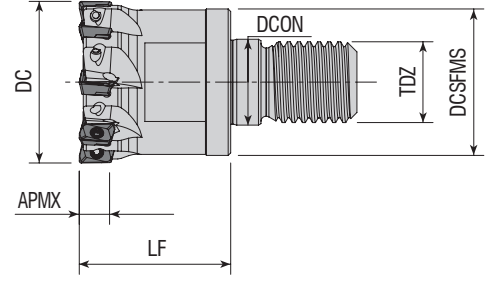

Takım Kodu
Ordering Code
Bestell-Bezeichnung

Stok
Stock
Lager

Takım Ölçüleri (mm)
Dimension (mm)
Abmessung (mm)

Kesici Uç
Insert
Wendeschneidplatte

Yedek Parçaları / Spare Parts / Ersatzteile

Sıkma Vidası
Screw
Schraube

Tork Anahtar
Torx Key
Torx-Schlüssel

AHFM-ED0702-D12-M06-L20-Z03
AHFM-ED0702-D16-M08-L25-Z04-H
AHFM-ED0702-D20-M10-L30-Z05-H
AHFM-ED0702-D25-M12-L30-Z06-H
AHFM-ED0702-D32-M16-L30-Z08-H

	DC	ZEPF	DCSFMS	TDZ	LF	DCON	APMX
●	12	3	10	M06	20	6.5	6
●	16	4	14.75	M08	25	8.5	6
●	20	5	18	M10	30	10.5	6
●	25	6	21	M12	30	12.5	6
●	32	8	29	M16	30	17	6

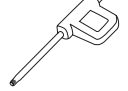
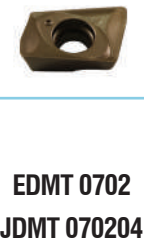

HTCH Ucuna Uygunur. / Compatible with HTCH Insert. / Kompatibel mit HTCH Wendeplatten.

ISCR Ucuna Uygunur. / Compatible with ISCR Insert. / Kompatibel mit ISCR Wendeplatten.

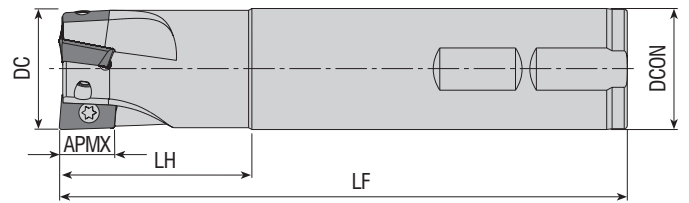

Takım Kodu
Ordering Code
Bestell-Bezeichnung

Stok
Stock
Lager

Takım Ölçüleri (mm)
Dimension (mm)
Abmessung (mm)

Kesici Uç
Insert
Wendeschneidplatte

Yedek Parçaları / Spare Parts / Ersatzteile

Sıkma Vidası
Screw
Schraube

Tork Anahtar
Torx Key
Torx-Schlüssel

AEM90-AD1505-D25-W25-L150-Z02
AEM90-AD1505-D30-W25-L150-Z03
AEM90-AD1505-D32-W32-L150-Z03

	DC	ZEPF	DCON	LF	LH	APMX
●	25	2	25	150	50	14.30
●	30	3	25	150	40	14.30
●	32	3	32	150	50	14.30

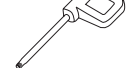

R: Sağ / Right / Rechts/ L: Sol / Left / Links

● Stokta / In Stock / Auf Lager ○ Stokta Yok / Non Stock Item / Kein Lagerartikel, Lieferzeit auf Anfrage

ISCR Ucuna Uygunur. / Compatible with ISCR Insert. / Kompatibel mit ISCR Wendeplatten.



Sipariş Örneği/Ordering Example/Bestellbeispiel

1 ad./pcs./stück AHFM-ED0702-D12-M06-L20-Z03



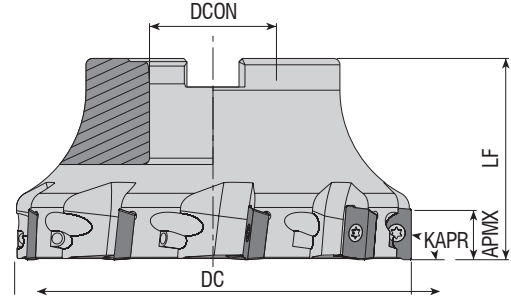

Kesme Hesabı : S 429 / Cutting Calculation : P 429 / Schnittberechnung : P 429

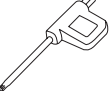
Sıkma Tork Değeri : S 428 / Tightening Torque : P 428 / Anzugsmoment : P 428

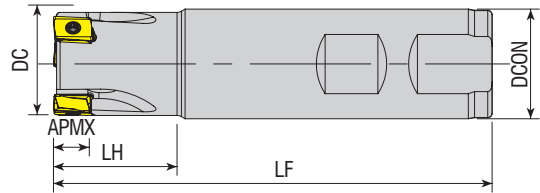

Takım Kodu Ordering Code Bestell-Bezeichnung	Stok Stock Lager	Takım Ölçüleri (mm) Dimension (mm) Abmessung (mm)					Kesici Uç Insert Wendeschneidplatte	Yedek Parçaları / Spare Parts / Ersatzteile		
		DC	ZEFP	DCON	LF	APMX		Sıkma Vidası Screw Schraube	Tork Anahtar Torx Key Torx-Schlüssel	Montaj Vidası Mounting Screw Befestigungsschraube
AFM90-AD1505-D040-A16-Z04-H	●	40	4	16	40	14.3				2506-M8x30
AFM90-AD1505-D050-A22-Z05-H	●	50	5	22	40	14.3				2508-M10x30
AFM90-AD1505-D063-A22-Z06-H	●	63	6	22	40	14.3				2510-M12x35
AFM90-AD1505-D080-A27-Z07-H	●	80	7	27	50	14.3				2514-M16x35
AFM90-AD1505-D100-A32-Z08-H	●	100	8	32	50	14.3				-
AFM90-AD1505-D125-B40-Z09	●	125	9	40	63	14.3				-

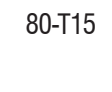

Takım Kodu Ordering Code Bestell-Bezeichnung	Stok Stock Lager	Takım Ölçüleri (mm) Dimension (mm) Abmessung (mm)						Kesici Uç Insert Wendeschneidplatte	Yedek Parçaları / Spare Parts / Ersatzteile		
		DC	ZEFP	DCON	LF	LH	APMX		Sıkma Vidası Screw Schraube	Tork Anahtar Torx Key Torx-Schlüssel	
AEM90-LN08-D16-W16-L100-Z02-H	●	16	2	16	100	28	8				
AEM90-LN08-D16-W16-L150-Z02	●	16	2	16	150	40	8				1707-U4-48x6
AEM90-LN08-D20-W20-L100-Z03-H	●	20	3	20	100	28	8				1707-U4-48x6.5
AEM90-LN08-D25-W25-L100-Z03-H	●	25	3	25	100	30	8				1707-U4-48x8.2
AEM90-LN08-D32-W32-L110-Z05-H	●	32	5	32	110	30	8				-
AEM90-LN1306-D32-W32-L150-Z03	●	32	3	32	150	50	12.5				
AEM90-LN1306-D32-C32-L110-Z03-H	●	32	3	32	110	40	12.5				4015-M4x11
new AEM90-LN1306-D40-W32-L150-Z04	●	40	4	32	150	35	12.5				-

R: Sağ / Right / Rechts / L: Sol / Left / Links

● Stokta / In Stock / Auf Lager ○ Stokta Yok / Non Stock Item / Kein Lagerartikel, Lieferzeit auf Anfrage

ISCR Ucuna Uygundur. / Compatible with ISCR Insert. / Kompatibel mit ISCR Wendeplatten.

Sipariş Örneği/Ordering Example/Bestellbeispiel

1 ad./pcs./stück AFM90-AD1505-D040-A16-Z04-H

Kesme Hesabı : S 429 / Cutting Calculation : P 429 / Schnittberechnung : P 429

ISCR Ucuna Uygun. / Compatible with ISCR Insert. / Kompatibel mit ISCR Wendeplatten.

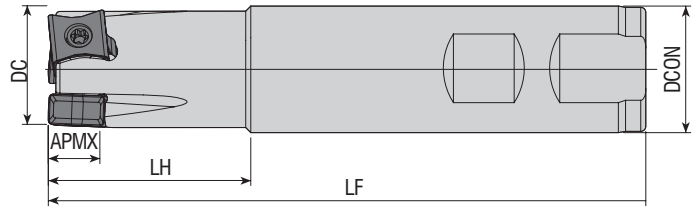

Takım Kodu Ordering Code Bestell-Bezeichnung	Stok Stock Lager	Takım Ölçüleri (mm) Dimension (mm) Abmessung (mm)						Kesici Uç Insert Wendeschneidplatte	Yedek Parçaları / Spare Parts / Ersatzteile	
		DC	ZEFP	DCON	LF	LH	APMX		Sıkma Vidası Screw Schraube	Tork Anahtar Torx Key Torx-Schlüssel
AEM90-LN1106-D25-W25-L150-Z03	●	25	3	25	150	40	10	LNMT 1106..		
AEM90-LN1106-D32-W32-L150-Z04	●	32	4	32	150	40	10			
AEM90-LN1106-D40-W32-L150-Z05	●	40	5	32	150	40	10			

ISCR Ucuna Uygun. / Compatible with ISCR Insert. / Kompatibel mit ISCR Wendeplatten.

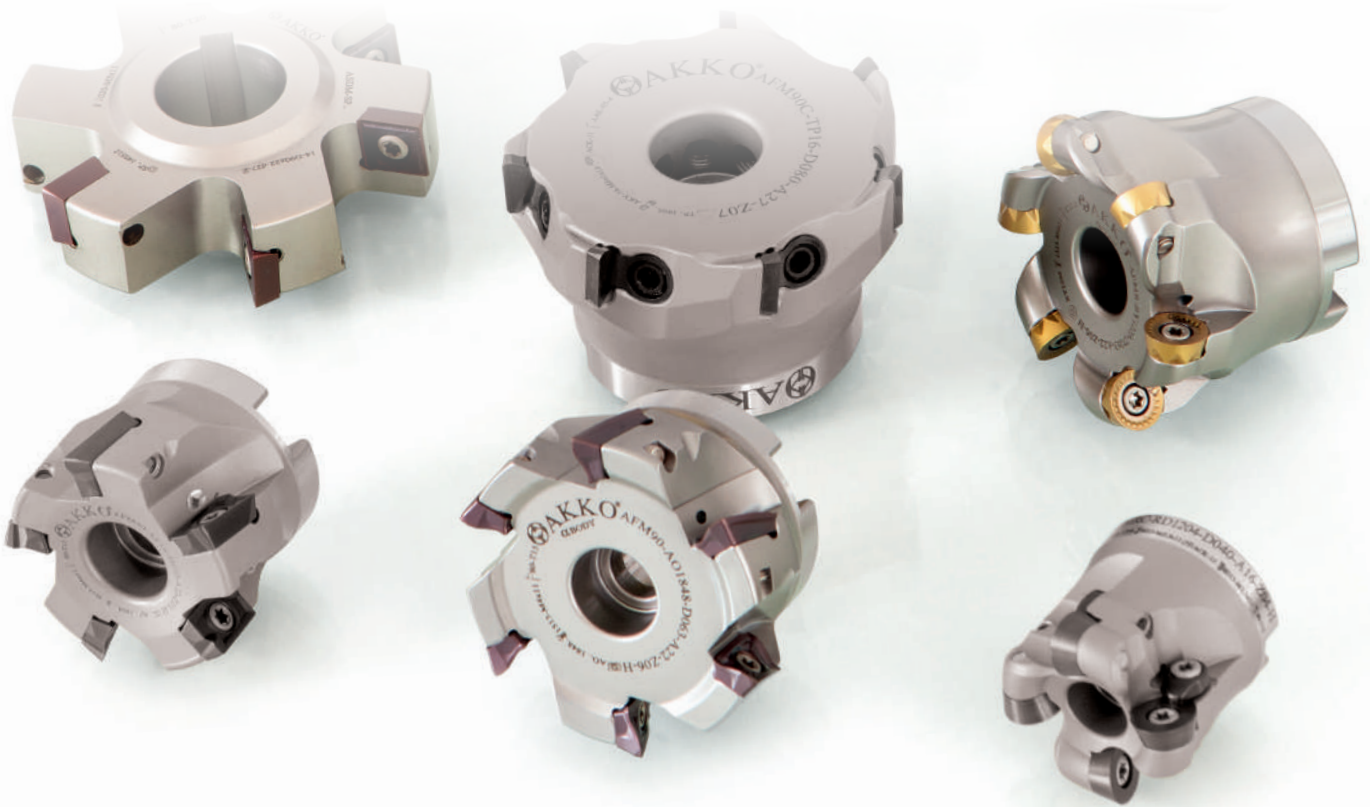

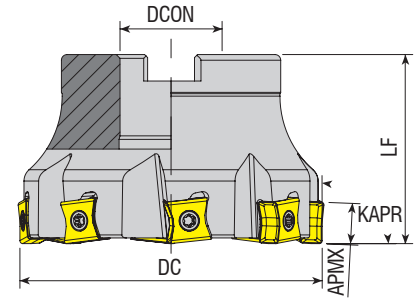

Takım Kodu Ordering Code Bestell-Bezeichnung	Stok Stock Lager	Takım Ölçüleri (mm) Dimension (mm) Abmessung (mm)					Kesici Uç Insert Wendeschneidplatte	Yedek Parçaları / Spare Parts / Ersatzteile			
		DC	ZEFP	DCON	LF	APMX		Sıkma Vidası Screw Schraube	Tork Anahtar Torx Key Torx-Schlüssel	Montaj Vidası Mounting Screw Befestigungsschraube	
new AFM90-LN1106-D040-A16-Z06	●	40	6	16	40	10	LNMT 1106..	4015-M3.5x11	80-T15	2506-M8x30	
AFM90-LN1106-D050-A22-Z05	●	50	5	22	40	10				2508-M10x30	
AFM90-LN1106-D063-A22-Z06	●	63	6	22	40	10				2510-M12x35	
AFM90-LN1106-D080-A27-Z08	●	80	8	27	50	10				2514-M16x35	
AFM90L-LN1106-D080-A27-Z08	●	80	8	27	50	10				-	
AFM90-LN1106-D100-A32-Z09	●	100	9	32	50	10				2506-M8x30	
AFM90L-LN1106-D100-A32-Z09	●	100	9	32	50	10				2508-M10x30	
AFM90-LN1106-D125-B40-Z10	●	125	10	40	63	10				2510-M12x35	
AFM90-LN1306-D040-A16-Z04-H	●	40	4	16	40	12.5	T490 LNMT 1306..	4015-M4x11	80-T15	2514-M16x35	
AFM90-LN1306-D050-A22-Z05-H	●	50	5	22	40	12.5				2506-M8x30	
AFM90-LN1306-D063-A22-Z06-H	●	63	6	22	40	12.5				2508-M10x30	
AFM90-LN1306-D080-A27-Z07-H	●	80	7	27	50	12.5				2510-M12x35	
AFM90-LN1306-D100-A32-Z08-H	●	100	8	32	50	12.5				2514-M16x35	
AFM90L-LN1506-D040-A16-Z04	●	40	4	16	40	14	LNMT 1506..	4015-M4x11	80-T20	2506-M8x30	
AFM90-LN1506-D040-A16-Z04	○	40	4	16	40	14				2508-M10x30	
AFM90-LN1506-D050-A22-Z05	○	50	5	22	40	14				2510-M12x35	
AFM90-LN1506-D063-A22-Z06	○	63	6	22	40	14				2514-M16x35	
AFM90-LN1506-D080-A27-Z07	○	80	7	27	50	14				-	
AFM90-LN1607-D050-A22-Z03-H	●	50	3	22	40	16	T490 LNHT 1607..	4420-M5x14	80-T20	2506-M8x30	
AFM90-LN1607-D063-A22-Z04-H	○	63	4	22	40	16				2508-M10x30	
new AFM90-LN1607-D063-A22-Z06-H	●	63	6	22	40	16				2510-M12x35	
AFM90-LN1607-D080-A27-Z05-H	●	80	5	27	50	16				2514-M16x35	
AFM90-LN1607-D100-A32-Z06-H	●	100	6	32	50	16				-	

R: Sağ / Right / Rechts L: Sol / Left / Links

● Stokta / In Stock / Auf Lager ○ Stokta Yok / Non Stock Item / Kein Lagerartikel, Lieferzeit auf Anfrage

ISCR Ucuna Uygundur. / Compatible with ISCR Insert. / Kompatibel mit ISCR Wendeplatten.

Sipariş Örneği/Ordering Example/Bestellbeispiel

1 ad./pcs./stück AFM90-LN1106-D040-A16-Z06

Kesme Hesabı : S 429 / Cutting Calculation : P 429 / Schnittberechnung : P 429

Montaj Ölçüleri : S 426 / Mounting Reference : P 426 / Montagehinweis : P 426

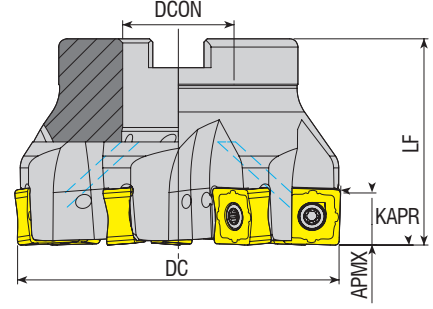

Takım Kodu Ordering Code Bestell-Bezeichnung	Stok Stock Lager	Takım Ölçüleri (mm) Dimension (mm) Abmessung (mm)					Kesici Uç Insert Wendeschneidplatte	Yedek Parçaları / Spare Parts / Ersatzteile				
		DC	ZEFP	DCON	LF	APMX		Sıkma Vidası Screw Schraube	Baskı Parçası Wedge Clamp Spannpratze	Baskı Vidası Clamp Screw Klemmschraube	Tork Anahtar Torx Key Torx-Schlüssel	Montaj Vidası Mounting Screw Befestigungsschraube
AFM89-SN1305I-D040-A16-Z04-H	●	40	4	16	40	10	SNMU 1305..	1015 M4x11			80-T15	2306-M8x37
AFM89-SN1305I-D050-A22-Z05-H	●	50	5	22	40	10						2508-M10x30
AFM89-SN1305I-D063-A22-Z06-H	●	63	6	22	40	10	SNMU 1305.. OXMT 0507..			80-T15	2510-M12x35	
AFM89-SN1305I-D063-A22-Z07-H	●	63	7	22	40	10					2514-M16x35	
AFM89-SN1305I-D080-A27-Z08-H	●	80	8	27	50	10						
AFM89-SN1305I-D100-A32-Z10-H	●	100	10	32	50	10						

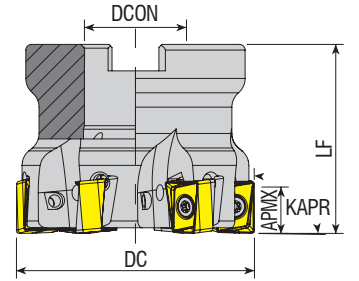

Takım Kodu Ordering Code Bestell-Bezeichnung	Stok Stock Lager	Takım Ölçüleri (mm) Dimension (mm) Abmessung (mm)					Kesici Uç Insert Wendeschneidplatte	Yedek Parçaları / Spare Parts / Ersatzteile			
		DC	ZEFP	DCON	LF	APMX		Sıkma Vidası Screw Schraube	Tork Anahtar Torx Key Torx-Schlüssel	Montaj Vidası Mounting Screw Befestigungsschraube	
AFM90-AN12-D040-A16-Z04-H	●	40	4	16	40	12	ANKX 1205..	4015-M4x12	80-T15	2406-M8x30	
AFM90-AN12-D050-A22-Z05-H	●	50	5	22	40	12				2508-M10x30	
AFM90-AN12-D063-A27-Z06-H	●	63	6	27	50	12				2510-M12x35	

R: Sağ / Right / Rechts/ L: Sol / Left / Links

● Stokta / In Stock / Auf Lager ○ Stokta Yok / Non Stock Item / Kein Lagerartikel, Lieferzeit auf Anfrage

ISCR Ucuna Uygundur. / Compatible with ISCR Insert. / Kompatibel mit ISCR Wendeplatten.



Sipariş Örneği/Ordering Example/Bestellbeispiel

1 ad./pcs./stück AFM89-SN1305I-D040-A16-Z04-H

Kesme Hesabı : S 429 / Cutting Calculation : P 429 / Schnittberechnung : P 429

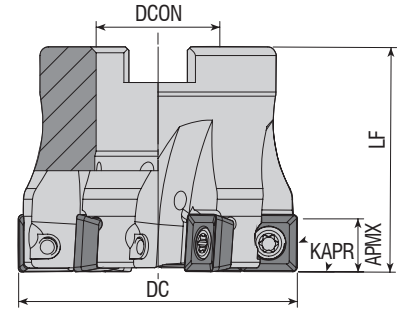
ISCR Ucuna Uygundur. / Compatible with ISCR Insert. / Kompatibel mit ISCR Wendeplatten.



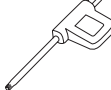

Takım Kodu Ordering Code Bestell-Bezeichnung	Stok Stock Lager	Takım Ölçüleri (mm) Dimension (mm) Abmessung (mm)					Kesici Uç Insert Wendeschneidplatte	Yedek Parçaları / Spare Parts / Ersatzteile		
		DC	ZEFP	DCON	LF	APMX		Sıkma Vidası Screw Schraube	Tork Anahtar Torx Key Torx-Schlüssel	Montaj Vidası Mounting Screw Befestigungsschraube
AFM90-SP1004-D040-A16-Z04-H	●	40	4	16	40	9.4	 SPMT 1004.. XPMT 1004.. QPMR 1004.. QPMT 1004..	 4015-M4x10	 80-T15	2506-M8x30
AFM90-SP1004-D050-A22-Z04-H	●	50	4	22	40	9.4				2508-M10x30
AFM90-SP1004-D050-A22-Z06-H	●	50	6	22	40	9.4				2510-M12x35
AFM90-SP1004-D063-A22-Z05-H	●	63	5	22	40	9.4				2514-M16x35
AFM90-SP1004-D080-A27-Z07-H	●	80	7	27	50	9.4				
AFM90-SP1004-D100-A32-Z08-H	●	100	8	32	50	9.4				

ISCR Ucuna Uygundur. / Compatible with ISCR Insert. / Kompatibel mit ISCR Wendeplatten.

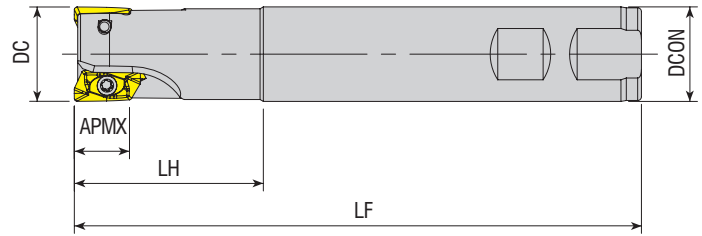
KNMTL Ucuna Uygundur. / Compatible with KNMTL Insert. / Kompatibel mit KNMTL Wendeplatten.



Takım Kodu Ordering Code Bestell-Bezeichnung	Stok Stock Lager	Takım Ölçüleri (mm) Dimension (mm) Abmessung (mm)						Kesici Uç Insert Wendeschneidplatte	Yedek Parçaları / Spare Parts / Ersatzteile	
		DC	ZEFP	DCON	LF	LH	APMX		Sıkma Vidası Screw Schraube	Tork Anahtar Torx Key Torx-Schlüssel
AEM90-ED10T3-D16-W16-L120-Z02	●	16	2	16	120	30	10	 EDPT 10T3..	3008-M2.5x5	 82-T08
AEM90-ED10T3-D20-W20-L120-Z02	●	20	2	20	120	30	10		3008-M2.5x6	
AEM90-ED1404-D20-W20-L150-Z02	●	20	2	20	150	50	14.5	 EDPT 1404..	3008-M3x6	
AEM90-ED1404-D25-W25-L150-Z02	●	25	2	25	150	50	14.5			
AEM90-ED1404-D30-C25-L150-Z03	●	30	3	25	150	50	14.5			

R: Sağ / Right / Rechts / L: Sol / Left / Links

● Stokta / In Stock / Auf Lager ○ Stokta Yok / Non Stock Item / Kein Lagerartikel, Lieferzeit auf Anfrage

KNMTL Ucuna Uygundur. / Compatible with KNMTL Insert. / Kompatibel mit KNMTL Wendeplatten.

Sipariş Örneği/Ordering Example/Bestellbeispiel
1 ad./pcs./stück AFM90-SP1004-D040-A16-Z04-H
Kesme Hesabı : S 429 / Cutting Calculation : P 429 / Schnittberechnung : P 429

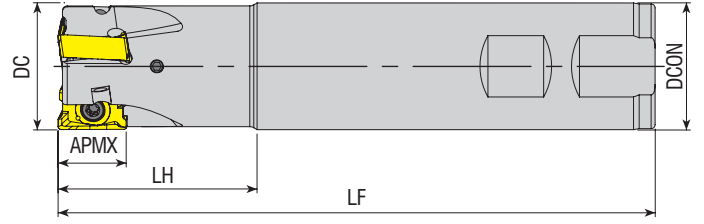

Takım Kodu Ordering Code Bestell-Bezeichnung	Stok Stock Lager	Takım Ölçüleri (mm) Dimension (mm) Abmessung (mm)						Kesici Uç Insert Wendeschneidplatte	Yedek Parçaları / Spare Parts / Ersatzteile		
		DC	ZEFP	DCON	LF	LH	APMX		Sıkma Vidası Screw Schraube	Tork Anahtar Torx Key Torx-Schlüssel	
AEM90-LN15T6-D25-W25-L150-Z02-H	●	25	2	25	150	50	15.5	LNGU 15T6..	4015-M4x12	80-T15	
AEM90-LN15T6-D32-W32-L150-Z03-H	●	32	3	32	150	50	15.5				
AEM90-LN15T6-D40-W32-L150-Z03-H	●	40	3	32	150	40	15.5				

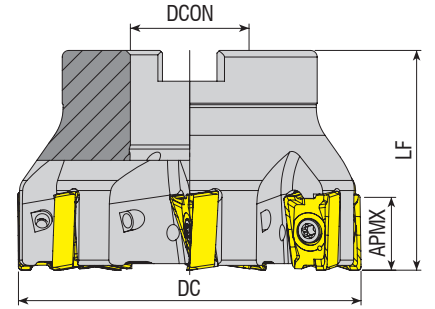

Takım Kodu Ordering Code Bestell-Bezeichnung	Stok Stock Lager	Takım Ölçüleri (mm) Dimension (mm) Abmessung (mm)					Kesici Uç Insert Wendeschneidplatte	Yedek Parçaları / Spare Parts / Ersatzteile			
		DC	ZEFP	DCON	LF	APMX		Sıkma Vidası Screw Schraube	Tork Anahtar Torx Key Torx-Schlüssel	Montaj Vidası Mounting Screw Befestigungsschraube	
AFM90-LN15T6-D050-A22-Z05-H	●	50	5	22	40	15.5	LNGU 15T6..	4015-M4x12	80-T15	2508-M10x30	
AFM90-LN15T6-D063-A22-Z06-H	●	63	6	22	40	15.5					
AFM90-LN15T6-D080-A27-Z07-H	●	80	7	27	50	15.5					

R: Sağ / Right / Rechts/ L: Sol / Left / Links

● Stokta / In Stock / Auf Lager ○ Stokta Yok / Non Stock Item / Kein Lagerartikel, Lieferzeit auf Anfrage

KNMTL Ucuna Uygundur. / Compatible with KNMTL Insert. / Kompatibel mit KNMTL Wendeplatten.

Sipariş Örneği/Ordering Example/Bestellbeispiel

1 ad./pcs./stück AEM90-LN15T6-D25-W25-L150-Z02-H

Kesme Hesabı : S 429 / Cutting Calculation : P 429 / Schnittberechnung : P 429

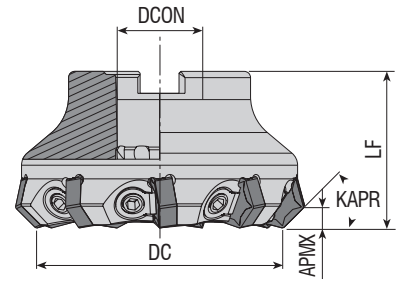

Takım Kodu Ordering Code Bestell-Bezeichnung	Stok Stock Lager	Takım Ölçüleri (mm) Dimension (mm) Abmessung (mm)					Kesici Uç Insert Wendeschneidplatte	Yedek Parçaları / Spare Parts / Ersatzteile			
		DC	ZEFP	DCON	LF	APMX		Baskı Parçası Wedge Clamp Spannpratze	Baskı Vidası Clamp Screw Klemmschraube	Anahtar Allen Key Innensechskantschlüssel	Montaj Vidası Mounting Screw Befestigungsschraube
AFM45C-HN0905-D063-A22-Z07	●	63	7	22	40	4.5	HN.. 0905..	ACK-11	AKV-15-M8x1x20	AAL-05-4	2508-M10x30
AFM45C-HN0905-D080-A27-Z09	●	80	9	27	50	4.5					2510-M12x35
AFM45C-HN0905-D100-A32-Z11	●	100	11	32	50	4.5					2514-M16x35
AFM45C-HN0905-D125-B40-Z13	●	125	13	40	63	4.5					-
AFM45CL-HN0905-D125-B40-Z10	●	125	10	40	63	4.5					-
AFM45C-HN0905-D160-C40-Z15	●	160	15	40	63	4.5					-

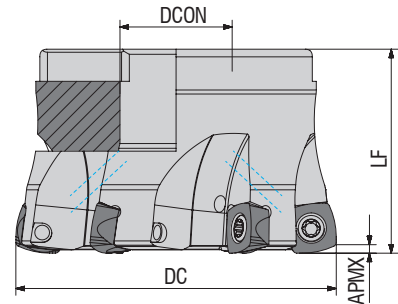

Takım Kodu Ordering Code Bestell-Bezeichnung	Stok Stock Lager	Takım Ölçüleri (mm) Dimension (mm) Abmessung (mm)					Kesici Uç Insert Wendeschneidplatte	Yedek Parçaları / Spare Parts / Ersatzteile		
		DCX	ZEFP	DCON	LF	APMX		Sıkma Vidası Screw Schraube	Tork Anahtar Torx Key Torx-Schlüssel	Montaj Vidası Mounting Screw Befestigungsschraube
AHFM-XD0904-D050-A22-Z05-H	●	50	5	22	40	1.5	XD.. 0904..	4015-M3.5x9	80-T15	2508-M10X30
AHFM-XD0904-D063-A22-Z06-H	●	63	6	22	40	1.5				

R: Sağ / Right / Rechts/ L: Sol / Left / Links

● Stokta / In Stock / Auf Lager ○ Stokta Yok / Non Stock Item / Kein Lagerartikel, Lieferzeit auf Anfrage

KNMTL Ucuna Uygundur. / Compatible with KNMTL Insert. / Kompatibel mit KNMTL Wendeplatten.

Sipariş Örneği/Ordering Example/Bestellbeispiel

1 ad./pcs./stück AFM45C-HN0905-D063-A22-Z07

Kesme Hesabı : S 429 / Cutting Calculation : P 429 / Schnittberechnung : P 429

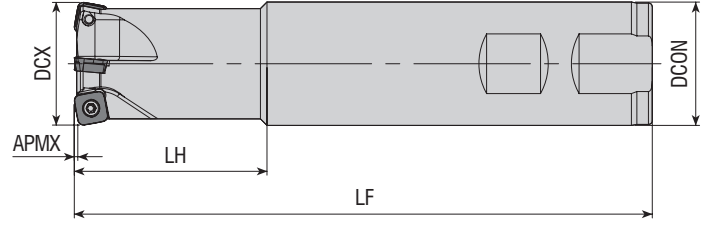

Takım Kodu Ordering Code Bestell-Bezeichnung	Stok Stock Lager	Takım Ölçüleri (mm) Dimension (mm) Abmessung (mm)						Kesici Uç Insert Wendeschneidplatte	Yedek Parçaları / Spare Parts / Ersatzteile		
		DCX	ZEPF	DCON	LF	LH	APMX		Sıkma Vidası Screw Schraube	Baskı Vidası Clamp Screw Schraube	Tork Anahtar Torx Key Torx-Schlüssel
AHFM-S00803-D20-W20-L150-Z02	●	20	2	20	150	50	1	SOMW 0803..	4010-M3x8	82-T10	
AHFM-S00803-D25-W25-L150-Z03	●	25	3	25	150	50	1				
AHFM-S00803-D32-W32-L150-Z04	●	32	4	32	150	50	1				
new AHFM-S00803-D35-W32-L160-Z04	●	35	4	32	160	50	1				

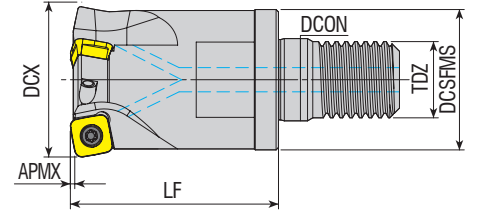

Takım Kodu Ordering Code Bestell-Bezeichnung	Stok Stock Lager	Takım Ölçüleri (mm) Dimension (mm) Abmessung (mm)							Kesici Uç Insert Wendeschneidplatte	Yedek Parçaları / Spare Parts / Ersatzteile			
		DCX	ZEPF	DCSFMS	TDZ	LF	DCON	APMX		Sıkma Vidası Screw Schraube	Baskı Parçası Wedge Clamp Spannpratze	Baskı Vidası Clamp Screw Schraube	Tork Anahtar Torx Key Torx-Schlüssel
AHFM-S00803-D20-M10-L30-Z02-H	●	20	2	18	M10	30	10.5	1	SOMW 0803..	4010-M3X8	-	-	82-T10
AHFM-S00803-D25-M12-L35-Z03-H	●	25	3	22	M12	35	12.5	1					
AHFM-S00803-D32-M16-L43-Z03-H	●	32	3	29	M16	43	17	1					
AHFM-S00803-D32-M16-L43-Z04-H	●	32	4	29	M16	43	17	1					
AHFM-S00803-D40-M16-L43-Z04-H	●	40	4	29	M16	43	17	1					
new AHFM-S00803-D40-M16-L43-Z05-H	●	40	5	29	M16	43	17	1					

R: Sağ / Right / Rechts/ L: Sol / Left / Links

● Stokta / In Stock / Auf Lager ○ Stokta Yok / Non Stock Item / Kein Lagerartikel, Lieferzeit auf Anfrage

KPTK Ucuna Uygundur. / Compatible with KPTK Insert. / Kompatibel mit KPTK Wendeplatten.

Sipariş Örneği/Ordering Example/Bestellbeispiel

1 ad./pcs./stück AHFM-S00803-D20-W20-L150-Z02

Kesme Hesabı : S 429 / Cutting Calculation : P 429 / Schnittberechnung : P 429

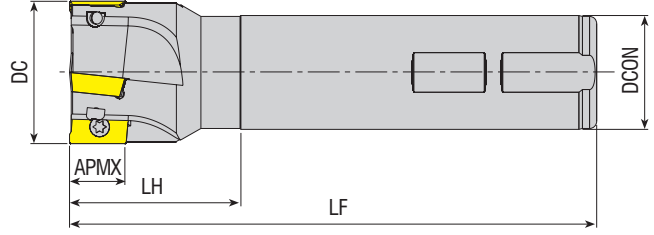

Takım Kodu Ordering Code Bestell-Bezeichnung	Stok Stock Lager	Takım Ölçüleri (mm) Dimension (mm) Abmessung (mm)						Kesici Uç Insert Wendeschneidplatte	Yedek Parçaları / Spare Parts / Ersatzteile		
		DC	ZEFP	DCON	LF	LH	APMX		Sıkma Vidası Screw Schraube	Tork Anahtar Torx Key Torx-Schlüssel	
AEM90-AP06-D10-C10-L120-Z02	●	10	2	10	120	20	5.6	APMT 0602..	3006-M1.8x4	82-T06	
AEM90-AP06-D12-C12-L120-Z02	●	12	2	12	120	20	5.6				
AEM90-AP0903-D12-C16-L080-Z01-H	●	12	1	16	80	30	9	APMT 0903..	3008-M2.5x5		
AEM90-AP0903-D16-C16-L090-Z02	●	16	2	16	90	30	9				
AEM90-AP0903-D16-C16-L150-Z02	●	16	2	16	150	30	9				
AEM90-AP0903-D17-C16-L150-Z02	●	17	2	16	150	30	9				
AEM90-AP0903-D18-C16-L090-Z02-H	●	18	2	16	90	30	9				
AEM90-AP0903-D20-C20-L110-Z03	●	20	3	20	110	30	9				
AEM90-AP0903-D20-C20-L150-Z02	●	20	2	20	150	30	9				
AEM90-AP0903-D20-C20-L200-Z02	●	20	2	20	200	100	9				
AEM90-AP0903-D21-C20-L150-Z02	●	21	2	20	150	30	9				
AEM90-AP0903-D25-C25-L120-Z03	●	25	3	25	120	30	9				
AEM90-AP0903-D25-C25-L150-Z03	●	25	3	25	150	30	9				
AEM90-AP0903-D25-C25-L200-Z02	●	25	2	25	200	100	9				

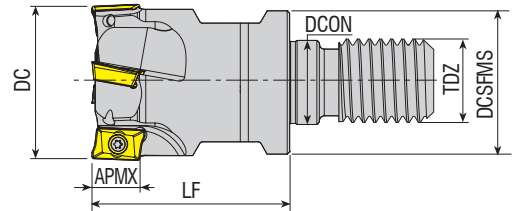

Takım Kodu Ordering Code Bestell-Bezeichnung	Stok Stock Lager	Takım Ölçüleri (mm) Dimension (mm) Abmessung (mm)							Kesici Uç Insert Wendeschneidplatte	Yedek Parçaları / Spare Parts / Ersatzteile		
		DC	ZEFP	DCSFMS	TDZ	LF	DCON	APMX		Sıkma Vidası Screw Schraube	Tork Anahtar Torx Key Torx-Schlüssel	
AEM90-AP0903-D20-M12-L35-Z03	●	20	3	18	M12	35	12.5	9	APMT 0903..	3008-M2.5x6	82-T08	
AEM90-AP0903-D25-M12-L35-Z03	●	25	3	21	M12	35	12.5	9				

R: Sağ / Right / Rechts/ L: Sol / Left / Links

● Stokta / In Stock / Auf Lager ○ Stokta Yok / Non Stock Item / Kein Lagerartikel, Lieferzeit auf Anfrage

KRRLY Ucuna Uygun. / Compatible with KRRLY Insert. / Kompatibel mit KRRLY Wendeplatten.

Sipariş Örneği/Ordering Example/Bestellbeispiel

1 ad./pcs./stück AEM90-AP06-D10-C10-L120-Z02

Kesme Hesabı : S 429 / Cutting Calculation : P 429 / Schnittberechnung : P 429

KRLY Ucuna Uygunur. / Compatible with KRLY Insert. / Kompatibel mit KRLY Wendeplatten.



KAPR=90°

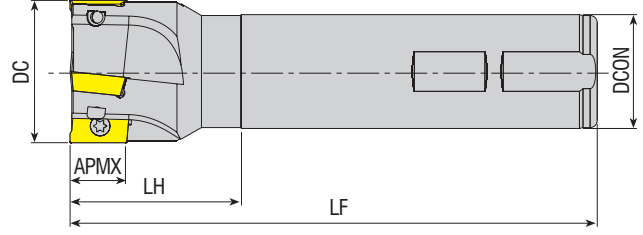

Takım Kodu Ordering Code Bestell-Bezeichnung	Stok Stock Lager	Takım Ölçüleri (mm) Dimension (mm) Abmessung (mm)						Kesici Uç Insert Wendeschneidplatte	Yedek Parçaları / Spare Parts / Ersatzteile		
		DC	ZEFP	DCON	LF	LH	APMX		Sıkma Vidası Screw Schraube	Tork Anahtar Torx Key Torx-Schlüssel	
AEM90-AP11KR-D25-C25-L180-Z04	●	25	4	25	180	50	11	AP. 11T3..		3008-2.5x6	
AEM90-AP11KR-D25-W25-L115-Z03-H	●	25	3	25	115	35	11				
AEM90-AP11KR-D32-W32-L125-Z04-H	●	32	4	32	125	40	11				



KAPR=90°

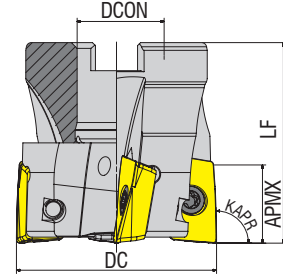

Takım Kodu Ordering Code Bestell-Bezeichnung	Stok Stock Lager	Takım Ölçüleri (mm) Dimension (mm) Abmessung (mm)					Kesici Uç Insert Wendeschneidplatte	Yedek Parçaları / Spare Parts / Ersatzteile			
		DC	ZEFP	DCON	LF	APMX		Sıkma Vidası Screw Schraube	Tork Anahtar Torx Key Torx-Schlüssel	Montaj Vidası Mounting Screw Befestigungsschraube	
AFM90-AP16KR-D040-A16-Z04-H	●	40	4	16	40	16	AP. 1604..				
AFM90-AP16KR-D050-A22-Z05-H	●	50	5	22	40	16					
AFM90-AP16KR-D063-A22-Z06-H	●	63	6	22	40	16					
AFM90-AP16KR-D080-A27-Z07-H	●	80	7	27	50	16					
AFM90-AP16KR-D100-A32-Z08-H	●	100	8	32	50	16					
AFM90-AP16KR-D125-B40-Z10-H	●	125	10	40	63	16					

R: Sağ / Right / Rechts! L: Sol / Left / Links

● Stokta / In Stock / Auf Lager ○ Stokta Yok / Non Stock Item / Kein Lagerartikel, Lieferzeit auf Anfrage

KRLY Ucuna Uygunur. / Compatible with KRLY Insert. / Kompatibel mit KRLY Wendeplatten.

Sipariş Örneği/Ordering Example/Bestellbeispiel

1 ad./pcs./stück AEM90-AP11KR-D25-C25-L180-Z04

Kesme Hesabı : S 429 / Cutting Calculation : P 429 / Schnittberechnung : P 429

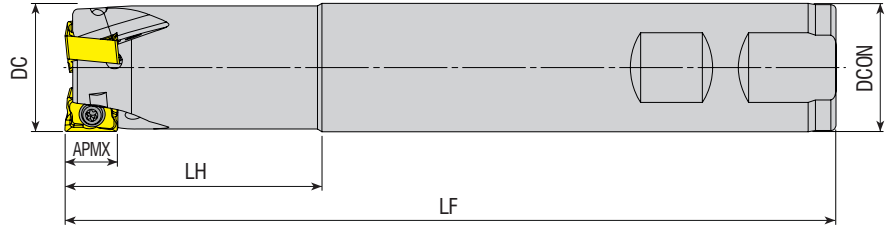

Takım Kodu Ordering Code Bestell-Bezeichnung	Stok Stock Lager	Takım Ölçüleri (mm) Dimension (mm) Abmessung (mm)						Kesici Uç Insert Wendeschneidplatte	Yedek Parçaları / Spare Parts / Ersatzteile		
		DC	ZEFP	DCON	LF	LH	APMX		Sıkma Vidası Screw Schraube	Tork Anahtar Torx Key Torx-Schlüssel	
AEM90-LN1006-D16-W16-L120-Z01-H	●	16	1	16	120	30	9	LN.X 1006..	4010-M3x8	82-T10	
AEM90-LN1006-D16-W16-L150-Z01	●	16	1	16	150	50	9				
AEM90-LN1006-D18-W16-L120-Z02-H	●	18	2	16	120	30	9				
AEM90-LN1006-D20-W20-L120-Z02-H	●	20	2	20	120	30	9				
AEM90-LN1006-D20-W20-L150-Z02	●	20	2	20	150	50	9				
AEM90-LN1006-D25-W25-L120-Z03-H	●	25	3	25	120	30	9				
AEM90-LN1006-D25-W25-L150-Z03	●	25	3	25	150	50	9				
AEM90-LN1006-D32-W32-L120-Z04-H	●	32	4	32	120	30	9				
AEM90-LN1006-D32-W32-L150-Z04	●	32	4	32	150	50	9				

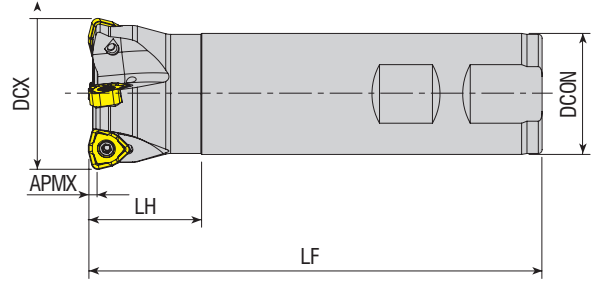

Takım Kodu Ordering Code Bestell-Bezeichnung	Stok Stock Lager	Takım Ölçüleri (mm) Dimension (mm) Abmessung (mm)						Kesici Uç Insert Wendeschneidplatte	Yedek Parçaları / Spare Parts / Ersatzteile		
		DCX	ZEFP	DCON	LF	LH	APMX		Sıkma Vidası Screw Schraube	Tork Anahtar Torx Key Torx-Schlüssel	
AHFM-WN0603-D16-C16-L110-Z02-H	●	16	2	16	110	30	1	WNMX 0603..	3008-M2.5x6	82-T08	
AHFM-WN0603-D16-C16-L150-Z02-H	●	16	2	16	150	70	1				
AHFM-WN0603-D17-C16-L150-Z02-H	●	17	2	16	150	20	1				
AHFM-WN0603-D20-C20-L150-Z02-H	●	20	2	20	150	70	1				
AHFM-WN0603-D20-C20-L200-Z02-H	●	20	2	20	200	100	1				
AHFM-WN0603-D21-C20-L150-Z02-H	●	21	2	20	150	20	1				
AHFM-WN09T3-D25-W25-L120-Z02-H	●	25	2	25	120	40	1.5	WNMX 09T3..	4010-M3x8	82-T10	
AHFM-LN-WN09T3-D25-W25-L120-Z02-H	●	25	2	25	120	40	1.5				
AHFM-WN09T3-D25-C25-L200-Z02	●	25	2	25	200	120	1.5				
AHFM-WN09T3-D32-W32-L120-Z03-H	●	32	3	32	120	30	1.5				
AHFM-WN09T3-D32-W32-L200-Z03-H	○	32	3	32	200	100	1.5				
AHFM-WN09T3-D35-W32-L200-Z04-H	●	35	4	32	200	50	1.5				
AHFM-WN09T3-D40-W32-L120-Z04-H	●	40	4	32	120	30	1.5				
AHFM-WN09T3-D40-C32-L200-Z04	●	40	4	32	200	30	1.5				
AHFM-WN1305-D32-C32-L150-Z02-H	○	32	2	32	150	70	2	WNMX 1305..	4015-M4x11	80-T15	
AHFM-WN1305-D32-C32-L200-Z02-H	●	32	2	32	200	120	2				
AHFM-WN1305-D40-C32-L200-Z03-H	●	40	3	32	200	30	2				

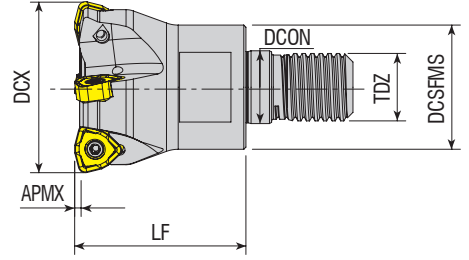

Takım Kodu Ordering Code Bestell-Bezeichnung	Stok Stock Lager	Takım Ölçüleri (mm) Dimension (mm) Abmessung (mm)							Kesici Uç Insert Wendeschneidplatte	Yedek Parçaları / Spare Parts / Ersatzteile		
		DCX	ZEFP	DCSFMS	TDZ	LF	DCON	APMX		Sıkma Vidası Screw Schraube	Tork Anahtar Torx Key Torx-Schlüssel	
AHFM-WN09T3-D32-M16-L40-Z03-H	●	32	3	29	M16	40	17	1.5	WNMX 09T3..	4010-M3x8	82-T10	
AHFM-WN09T3-D35-M16-L40-Z04-H	●	35	4	26	M16	40	17	1.5				
AHFM-WN09T3-D40-M16-L40-Z04-H	●	40	4	29	M16	40	17	1.5				

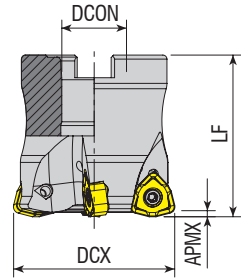

Takım Kodu Ordering Code Bestell-Bezeichnung	Stok Stock Lager	Takım Ölçüleri (mm) Dimension (mm) Abmessung (mm)					Kesici Uç Insert Wendeschneidplatte	Yedek Parçaları / Spare Parts / Ersatzteile			
		DCX	ZEFP	DCON	LF	APMX		Sıkma Vidası Screw Schraube	Tork Anahtar Torx Key Torx-Schlüssel	Montaj Vidası Mounting Screw Befestigungsschraube	
AHFM-WN09T3-D040-A16-Z04-H	●	40	4	16	40	1.5	WNMX 09T3..	4010-M3x8	82-T10	2506-M8x30	
AHFML-WN09T3-D040-A16-Z04-H	●	40	4	16	40	1.5					
AHFM-WN09T3-D050-A22-Z05-H	●	50	5	22	40	1.5					
AHFML-WN09T3-D050-A22-Z05-H	●	50	5	22	40	1.5					
AHFM-WN09T3-D063-A22-Z06-H	●	63	6	22	40	1.5				2508-M10x30	

R: Sağ / Right / Rechts L: Sol / Left / Links

● Stokta / In Stock / Auf Lager ○ Stokta Yok / Non Stock Item / Kein Lagerartikel, Lieferzeit auf Anfrage

KRLY Ucuna Uygun. / Compatible with KRLY Insert. / Kompatibel mit KRLY Wendeplatten.

Sipariş Örneği/Ordering Example/Bestellbeispiel

1 ad./pcs./stück AHFM-WN09T3-D32-M16-L40-Z03-H

Kesme Hesabı : S 429 / Cutting Calculation : P 429 / Schnittberechnung : P 429

Sıkma Tork Değeri : S 428 / Tightening Torque : P 428 / Anzugsmoment : P 428

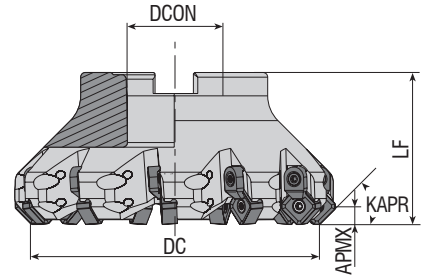
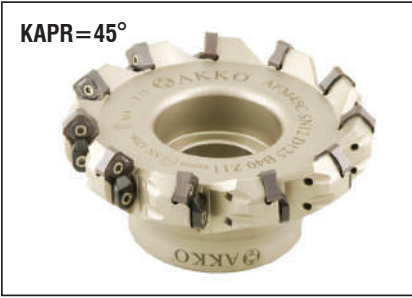

Takım Kodu Ordering Code Bestell-Bezeichnung	Stok Stock Lager	Takım Ölçüleri (mm) Dimension (mm) Abmessung (mm)					Kesici Uç Insert Wendeschneidplatte	Yedek Parçaları / Spare Parts / Ersatzteile									
		DC	ZEFP	DCON	LF	APMX		Sıkma Vidası Screw Schraube	Baskı Parçası Wedge Clamp Spannpratze	Baskı Vidası Clamp Screw Klemmschraube	Tork Anahtar Torx Key Torx-Schlüssel	Montaj Vidası Mounting Screw Befestigungsschraube					
AFM45C-SN1206-D050-A22-Z04-H	●	50	4	22	42	6	SN.. 1206..	4015-M4x11	ACK-05	4015-M4x11	80-T15	2407-M10x30					
AFM45CL-SN1206-D050-A22-Z05-H	●	50	5	22	42	6											
AFM45C-SN1206-D050-A22-Z05-H	●	50	5	22	42	6											
AFM45C-SN1206-D063-A22-Z06-H	●	63	6	22	42	6											
AFM45C-SN1206-D063-A22-Z07-H	●	63	7	22	42	6											
AFM45CL-SN1206-D063-A22-Z07-H	●	63	7	22	42	6											
AFM45C-SN1206-D080-A27-Z07-H	●	80	7	27	52	6											
AFM45C-SN1206-D080-A27-Z08-H	●	80	8	27	52	6											
AFM45CL-SN1206-D080-A27-Z08-H	●	80	8	27	52	6											
AFM45C-SN1206-D100-A32-Z08-H	●	100	8	32	52	6											
AFM45C-SN1206-D100-A32-Z10-H	●	100	10	32	52	6											
AFM45CL-SN1206-D100-A32-Z10-H	●	100	10	32	52	6											
AFM45C-SN1206-D125-B40-Z11	●	125	11	40	65	6											
AFM45CL-SN1206-D125-B40-Z11	●	125	11	40	65	6											
AFM45C-SN1206-D160-C40-Z12	●	160	12	40	65	6											
AFM45CL-SN1206-D160-C40-Z12	●	160	12	40	65	6											
AFM45C-SN1206-D200-C60-Z14	●	200	14	60	65	6											
AFM45CL-SN1206-D200-C60-Z14	●	200	14	60	65	6											
												1015-M4x11					2514-M16x35
																	2514-M16x35
												-					

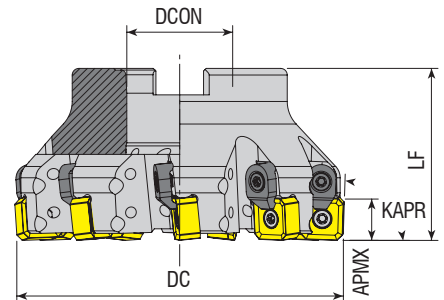
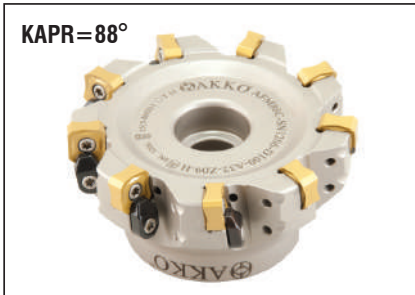

Takım Kodu Ordering Code Bestell-Bezeichnung	Stok Stock Lager	Takım Ölçüleri (mm) Dimension (mm) Abmessung (mm)					Kesici Uç Insert Wendeschneidplatte	Yedek Parçaları / Spare Parts / Ersatzteile						
		DC	ZEFP	DCON	LF	APMX		Sıkma Vidası Screw Schraube	Baskı Parçası Wedge Clamp Spannpratze	Baskı Vidası Clamp Screw Klemmschraube	Tork Anahtar Torx Key Torx-Schlüssel	Montaj Vidası Mounting Screw Befestigungsschraube		
AFM88C-SN1206-D040-A16-Z04-H	●	40	4	16	40	11.5	SN.. 1206..	4615-M4x11	ACK-05	4015-M4x11	80-T15	AKV-35-M8x34		
AFM88C-SN1206-D050-A22-Z05-H	●	50	5	22	40	11.5						4615-M4x11	2508-M10x30	
AFM88C-SN1206-D063-A22-Z06-H	●	63	6	22	40	11.5								
AFM88C-SN1206-D080-A27-Z07-H	●	80	7	27	50	11.5								
AFM88C-SN1206-D100-A32-Z09-H	●	100	9	32	52	11.5								
AFM88C-SN1206-D125-B40-Z10	●	125	10	40	63	11.5						1015-M4x11		
												2514-M16x35		
												2506-M8x30		

KAPR=45°

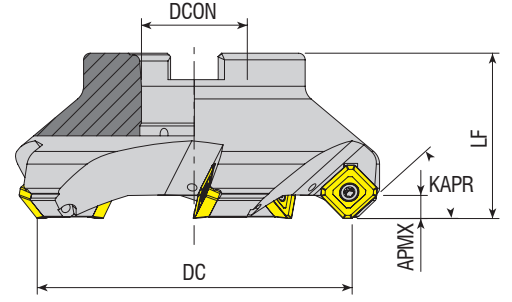

Takım Kodu
Ordering Code
Bestell-Bezeichnung

Stok
Stock
Lager

Takım Ölçüleri (mm)
Dimension (mm)
Abmessung (mm)

Kesici Uç
Insert
Wendeschneidplatte

Sıkma Vidası
Screw
Schraube

Tork Anahtar
Torx Key
Torx-Schlüssel

Montaj Vidası
Mounting Screw
Befestigungsschraube

Yedek Parçaları / Spare Parts / Ersatzteile

AFM45-SE14M4-D063-A22-Z04-H
AFM45-SE14M4-D080-A27-Z05-H
AFM45-SE14M4-D100-A32-Z05-H
AFM45-SE14M4-D125-B40-Z06
AFM45-SE14M4-D160-C40-Z07

●

DC

ZEPF

DCON

LF

APMX

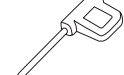

2407-M10x30
2510-M12x35
2514-M16x35
-

SE.. 14M4..

4015-M3.5x11

80-T15

KAPR=90°

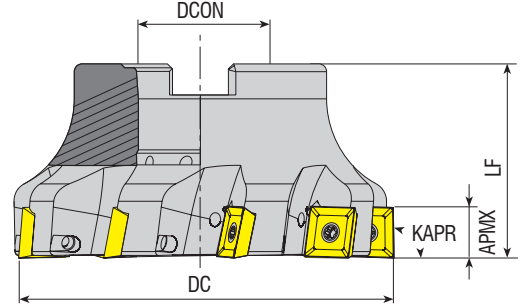

Takım Kodu
Ordering Code
Bestell-Bezeichnung

Stok
Stock
Lager

Takım Ölçüleri (mm)
Dimension (mm)
Abmessung (mm)

Kesici Uç
Insert
Wendeschneidplatte

Sıkma Vidası
Screw
Schraube

Tork Anahtar
Torx Key
Torx-Schlüssel

Montaj Vidası
Mounting Screw
Befestigungsschraube

Yedek Parçaları / Spare Parts / Ersatzteile

AFM90-SD09M4-D040-A16-Z04-H
AFM90-SD09M4-D050-A22-Z05-H
AFM90-SD09M4-D063-A22-Z06-H
AFM90-SD09M4-D080-A27-Z07-H
AFM90-SD1305-D050-A22-Z04-H
AFM90-SD1305-D063-A22-Z05-H
AFM90-SD1305-D080-A27-Z06-H
AFM90-SD1305-D100-A32-Z07-H
AFM90-SD1305-D125-B40-Z08
AFM90-SD1305-D160-C40-Z10

●

DC

ZEPF

DCON

LF

APMX

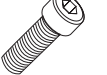
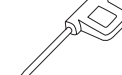

2406-M8x30

2508-M10x30

2510-M12x35

2408-M10x30

2508-M10x30

2510-M12x35

2514-M16x35
-

SD.. 09M4..

4015-M3.5x11

80-T15

SD.. 1305..

1020-M5x11

80-T20

R: Sağ / Right / Rechts / L: Sol / Left / Links

● Stokta / In Stock / Auf Lager ○ Stokta Yok / Non Stock Item / Kein Lagerartikel, Lieferzeit auf Anfrage

KRLY Ucuna Uygundur. / Compatible with KRLY Insert. / Kompatibel mit KRLY Wendeplatten.

Sipariş Örneği/Ordering Example/Bestellbeispiel

1 ad./pcs./stück AFM45-SE14M4-D063-A22-Z04-H

Kesme Hesabı : S 429 / Cutting Calculation : P 429 / Schnittberechnung : P 429

Sıkma Tork Değeri : S 428 / Tightening Torque : P 428 / Anzugsmoment : P 428



KAPR=90°

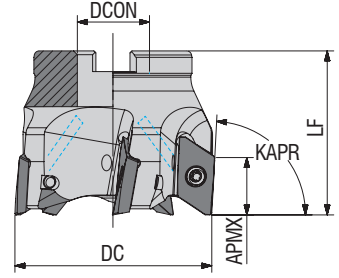

Takım Kodu
Ordering Code
Bestell-Bezeichnung

Takım Kodu Ordering Code Bestell-Bezeichnung	Stok Stock Lager	Takım Ölçüleri (mm) Dimension (mm) Abmessung (mm)					Kesici Uç Insert Wendeschneidplatte	Yedek Parçaları / Spare Parts / Ersatzteile		
		DC	ZEFP	DCON	LF	APMX		Sıkma Vidası Screw Schraube	Tork Anahtar Torx Key Torx-Schlüssel	Montaj Vidası Mounting Screw Befestigungsschraube
AFM90-XE19-D040-A16-Z03-H	●	40	3	16	50	17				
AFM90-XE19-D050-A22-Z04-H	●	50	4	22	50	17	XE.. 19M5..	3015-M4x11	80-T15	2506-M8x30
AFM90-XE19-D063-A22-Z05-H	●	63	5	22	50	17				2508-M10x30
										2508-M10x30

KRLY Ucuna Uygundur. / Compatible with KRLY Insert. / Kompatibel mit KRLY Wendeplatten.

Sipariş Örneği/Ordering Example/Bestellbeispiel





1 ad./pcs./stück AFM90-XE19-D040-A16-Z03-H

Kesme Hesabı : S 429 / Cutting Calculation : P 429 / Schnittberechnung : P 429

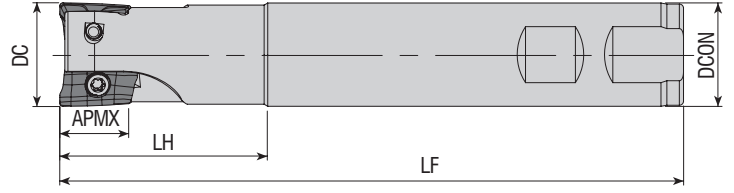
Sıkma Tork Değeri : S 428 / Tightening Torque : P 428 | Anzugsmoment : P 428



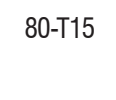

Takım Kodu Ordering Code Bestell-Bezeichnung	Stok Stock Lager	Takım Ölçüleri (mm) Dimension (mm) Abmessung (mm)						Kesici Uç Insert Wendeschneidplatte	Yedek Parçaları / Spare Parts / Ersatzteile		
		DC	ZEPF	DCON	LF	LH	APMX		Sıkma Vidası Screw Schraube	Tork Anahtar Torx Key Torx-Schlüssel	
AEM90-BD11T3-D16-C16-L100-Z02-H	●	16	2	16	100	30	10				
AEM90-BD11T3-D16-W16-L100-Z02-H	●	16	2	16	100	30	10				
AEM90-BD11T3-D16-W16-L150-Z02	●	16	2	16	150	50	10				
AEM90-BD11T3-D16-C16-L160-Z02-H	●	16	2	16	160	60	10				
AEM90-BD11T3-D16-C15-L180-Z02	●	16	2	15	180	50	10				
AEM90-BD11T3-D17-W16-L150-Z02	●	17	2	16	150	25	10				
AEM90-BD11T3-D17-C16-L180-Z02	●	17	2	16	180	25	10				
AEM90-BD11T3-D18-W16-L100-Z02	●	18	2	16	100	25	10				
AEM90-BD11T3-D18-W16-L100-Z02-H	●	18	2	16	100	25	10				
AEM90-BD11T3-D20-W16-L61-Z03	●	20	3	16	61	26	10				
AEM90-BD11T3-D20-W20-L81-Z03-H	●	20	3	20	81	30	10				
AEM90-BD11T3-D20-W20-L100-Z02-H	●	20	2	20	100	30	10				
AEM90-BD11T3-D20-W20-L100-Z03-H	●	20	3	20	100	30	10				
AEM90-BD11T3-D20-C20-L110-Z03-H	●	20	3	20	110	30	10				
AEM90-BD11T3-D20-W20-L150-Z02	●	20	2	20	150	50	10				
AEM90-BD11T3-D20-W20-L150-Z03	●	20	3	20	150	50	10				
AEM90-BD11T3-D20-W20-L150-Z03-H	●	20	3	20	150	50	10				
AEM90-BD11T3-D20-C20-L170-Z03-H	●	20	3	20	170	60	10				
AEM90-BD11T3-D21-W20-L150-Z03	●	21	3	20	150	25	10				
AEM90-BD11T3-D21-C20-L200-Z02	●	21	2	20	200	25	10				
AEM90-BD11T3-D22-W20-L090-Z02-H	●	22	2	20	90	25	10				
AEM90-BD11T3-D22-W20-L100-Z03-H	●	22	3	20	100	30	10				
AEM90-BD11T3-D25-W25-L100-Z03-H	●	25	3	25	100	30	10				
AEM90-BD11T3-D25-C20-L120-Z03-H	●	25	3	20	120	30	10				
AEM90-BD11T3-D25-C25-L120-Z03-H	●	25	3	25	120	30	10				
AEM90-BD11T3-D25-W25-L150-Z03	●	25	3	25	150	50	10				
AEM90-BD11T3-D26-W25-L150-Z03	●	26	3	25	150	35	10				
AEM90-BD11T3-D26-C25-L250-Z02	●	26	2	25	250	35	10				
AEM90-BD11T3-D32-W32-L110-Z04-H	●	32	4	32	110	40	10				
AEM90-BD11T3-D32-C32-L130-Z04-H	●	32	4	32	130	40	10				
AEM90-BD11T3-D32-W32-L150-Z04	●	32	4	32	150	50	10				
AEM90-BD11T3-D40-W32-L110-Z04-H	●	40	4	32	110	35	10				
AEM90-BD1704-D25-W25-L100-Z02-H	●	25	2	25	100	35	15.7				
AEM90-BD1704-D25-W25-L150-Z02	●	25	2	25	150	50	15.7				
AEM90-BD1704-D25-C25-L210-Z02-H	●	25	2	25	210	100	15.7				
AEM90-BD1704-D32-W32-L110-Z03-H	●	32	3	32	110	40	15.7				
AEM90-BD1704-D32-C32-L130-Z03-H	●	32	3	32	130	40	15.7				
AEM90-BD1704-D32-W32-L130-Z03-H	●	32	3	32	130	40	15.7				
AEM90-BD1704-D32-W32-L150-Z03	●	32	3	32	150	50	15.7				
AEM90-BD1704-D40-W32-L110-Z04-H	●	40	4	32	110	40	15.7				
AEM90-BD1704-D40-W32-L150-Z04	●	40	4	32	150	40	15.7				



KAPR=90°

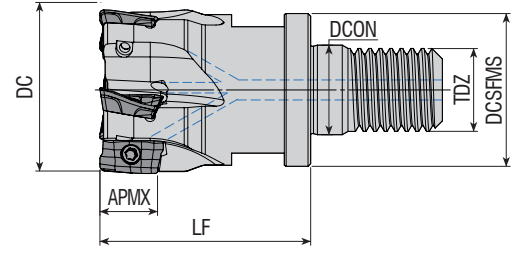

Takım Kodu Ordering Code Bestell-Bezeichnung	Stok Stock Lager	Takım Ölçüleri (mm) Dimension (mm) Abmessung (mm)						Kesici Uç Insert Wendeschneidplatte	Yedek Parçaları / Spare Parts / Ersatzteile		
		DC	ZEFP	DCSFMS	TDZ	LF	DCON		APMX	Sıkma Vidası Screw Schraube	Tork Anahtar Torx Key Torx-Schlüssel
AEM90-BD11T3-D16-M08-L25-Z02-H	●	16	2	14.75	M08	25	8.5	10			
AEM90-BD11T3-D25-M12-L35-Z04-H	●	25	4	21	M12	35	12.5	10	BDMT 11T3..	3008-M2.5x6	82-T08
AEM90-BD11T3-D32-M16-L40-Z05-H	●	32	5	29	M16	40	17	10			



KAPR=90°

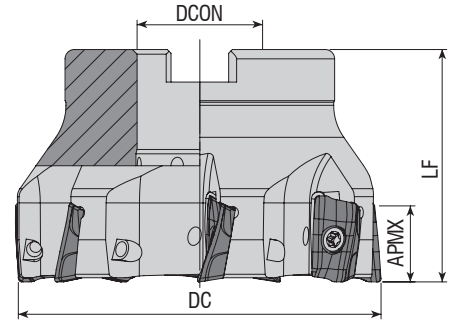

Takım Kodu Ordering Code Bestell-Bezeichnung	Stok Stock Lager	Takım Ölçüleri (mm) Dimension (mm) Abmessung (mm)					Kesici Uç Insert Wendeschneidplatte	Yedek Parçaları / Spare Parts / Ersatzteile			
		DC	ZEFP	DCON	LF	APMX		Sıkma Vidası Screw Schraube	Tork Anahtar Torx Key Torx-Schlüssel	Montaj Vidası Mounting Screw Befestigungsschraube	
new AFM90-BD0703-D032-A16-Z08-H	●	32	8	16	40	6	BDMT 0703	-	-	2506-M8x30	
AFM90-BD11T3-D040-A16-Z04-H	●	40	4	16	40	10	BDMT 11T3..	3008-M2.5x6	82-T08	2508-M10x30	
AFM90-BD11T3-D040-A16-Z05-H	●	40	5	16	40	10				2510-M12x35	
AFM90-BD11T3-D050-A22-Z05-H	●	50	5	22	40	10				2510-M12x35	
AFM90-BD11T3-D063-A22-Z06-H	●	63	6	22	40	10				2510-M12x35	
new AFM90-BD11T3-D080-A27-Z09-H	●	80	9	27	50	10	BDMT 1704..	4015-M4x11	80-T15	2508-M10x30	
AFM90-BD1704-D050-A22-Z04-H	●	50	4	22	40	15.7				2510-M12x35	
AFM90-BD1704-D050-A22-Z05-H	●	50	5	22	40	15.7				2510-M12x35	
AFM90-BD1704-D063-A22-Z06-H	●	63	6	22	40	15.7				2510-M12x35	
AFM90-BD1704-D080-A27-Z06-H	●	80	6	27	50	15.7				2510-M12x35	
AFM90-BD1704-D080-A27-Z07-H	●	80	7	27	50	15.7				2510-M12x35	
AFM90-BD1704-D080-A27-Z07-H	●	80	7	27	50	15.7				2510-M12x35	
AFM90-BD1704-D100-A32-Z07-H	●	100	7	32	50	15.7				2514-M16x35	

R: Sağ / Right / Rechts / L: Sol / Left / Links

● Stokta / In Stock / Auf Lager ○ Stokta Yok / Non Stock Item / Kein Lagerartikel, Lieferzeit auf Anfrage

KYCR Ucuna Uygundur. / Compatible with KYCR Insert. / Kompatibel mit KYCR Wendeplatten.

Sipariş Örneği/Ordering Example/Bestellbeispiel

1 ad./pcs./stück AEM90-BD11T3-D16-M08-L25-Z02-H

Kesme Hesabı : S 429 / Cutting Calculation : P 429 / Schnittberechnung : P 429

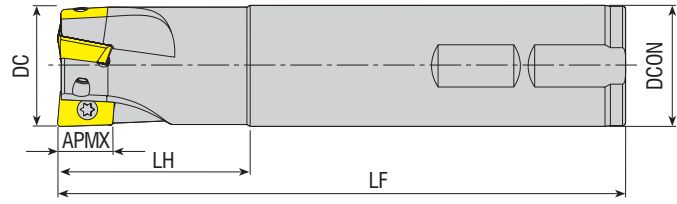

Takım Kodu Ordering Code Bestell-Bezeichnung	Stok Stock Lager	Takım Ölçüleri (mm) Dimension (mm) Abmessung (mm)						Kesici Uç Insert Wendeschneidplatte	Yedek Parçaları / Spare Parts / Ersatzteile		
		DC	ZEFP	DCON	LF	LH	APMX		Sıkma Vidası Screw Schraube	Tork Anahtar Torx Key Torx-Schlüssel	
AEM90-LO10-D16-W16-L100-Z02	●	16	2	16	100	30	10	LOMU 1004..	1108-M3x6	82-T08	
AEM90-LO10-D16-W16-L160-Z02	●	16	2	16	160	50	10				
AEM90-LO10-D20-W20-L130-Z03	●	20	3	20	130	40	10				
AEM90-LO10-D25-W25-L150-Z03	●	25	3	25	150	50	10				
AEM90-LO10-D32-W32-L150-Z04	●	32	4	32	150	50	10				

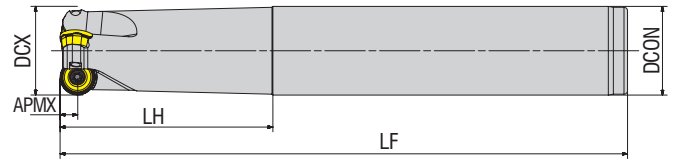

Takım Kodu Ordering Code Bestell-Bezeichnung	Stok Stock Lager	Takım Ölçüleri (mm) Dimension (mm) Abmessung (mm)						Kesici Uç Insert Wendeschneidplatte	Yedek Parçaları / Spare Parts / Ersatzteile			
		DCX	ZEFP	DCON	LF	LH	APMX		Sıkma Vidası Screw Schraube	Baskı Parçası Wedge Clamp Spannpratze	Baskı Vidası Clamp Screw Schraube	Tork Anahtar Torx Key Torx-Schlüssel
AEMR-RP10T3K-D20-C20-L160-Z02	●	20	2	20	160	60	5	RPMT 10T3..	4010-M3x8	-	-	82-T10
AEMR-RP10T3K-D25-C25-L160-Z03	●	25	3	25	160	60	5					

R: Sağ / Right / Rechts/ L: Sol / Left / Links

● Stokta / In Stock / Auf Lager ○ Stokta Yok / Non Stock Item / Kein Lagerartikel, Lieferzeit auf Anfrage

KYCR Ucuna Uygundur. / Compatible with KYCR Insert. / Kompatibel mit KYCR Wendeplatten.

Sipariş Örneği/Ordering Example/Bestellbeispiel
1 ad./pcs./stück AEM90-LO10-D16-W16-L100-Z02

Kesme Hesabı : S 429 / Cutting Calculation : P 429 / Schnittberechnung : P 429

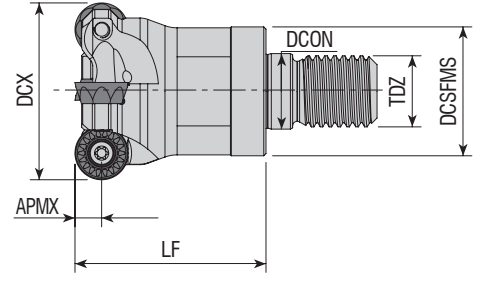

Takım Kodu Ordering Code Bestell-Bezeichnung	Stok Stock Lager	Takım Ölçüleri (mm) Dimension (mm) Abmessung (mm)							Kesici Uç Insert Wendeschneidplatte	Yedek Parçaları / Spare Parts / Ersatzteile		
		DCX	ZEFP	DCSFMS	TDZ	LF	DCON	APMX		Sıkma Vidası Screw Schraube	Tork Anahtar Torx Key Torx-Schlüssel	
AEMR-RP10T3K-D32-M16-L43-Z04-H	●	32	4	29	M16	43	17	5	RPMT 10T3..		4010-M3x8	82-T10
AEMR-RP10T3K-D42-M16-L43-Z05-H	●	42	5	29	M16	43	17	5				

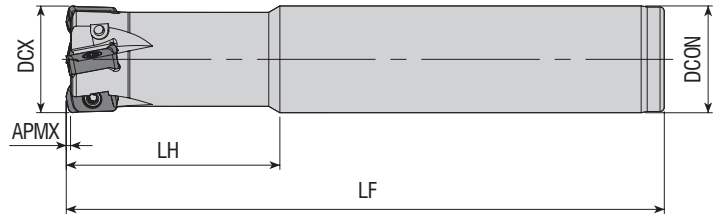

Takım Kodu Ordering Code Bestell-Bezeichnung	Stok Stock Lager	Takım Ölçüleri (mm) Dimension (mm) Abmessung (mm)							Kesici Uç Insert Wendeschneidplatte	Yedek Parçaları / Spare Parts / Ersatzteile		
		DCX	ZEFP	DCON	LF	LH	APMX	Sıkma Vidası Screw Schraube		Tork Anahtar Torx Key Torx-Schlüssel		
AHFM-L003-D16-C15-L160-Z02	●	16	2	15	160	30	1	LOGU 0303..		1108-M3x6.8	82-T08	
AHFM-L003-D16-C16-L100-Z02-F	●	16	2	16	100	30	1					
AHFM-L003-D16-C16-L100-Z02	●	16	2	16	100	30	1					
AHFM-L003-D16-C16-L130-Z02-H	●	16	2	16	130	40	1					
AHFM-L003-D16-C16-L160-Z02	●	16	2	16	160	50	1					
AHFM-L003-D16-C16-L160-Z02-H	●	16	2	16	160	100	1					
AHFM-L003-D16-C16-L220-Z02-H	●	16	2	16	220	120	1					
AHFM-L003-D17-C16-L180-Z02	●	17	2	16	180	30	1					
AHFM-L003-D20-C20-L130-Z03	●	20	3	20	130	40	1					
AHFM-L003-D20-C20-L130-Z03-H	●	20	3	20	130	40	1					
AHFM-L003-D20-C20-L160-Z03	●	20	3	20	160	80	1					
AHFM-L003-D20-C20-L160-Z03-H	●	20	3	20	160	100	1					
AHFM-L003-D21-C20-L150-Z03-H	●	21	3	20	150	30	1					
AHFM-L003-D21-C20-L200-Z03	●	21	3	20	200	30	1					
AHFM-L003-D21-C20-L200-Z03-H	●	21	3	20	200	30	1					
AHFM-L003-D25-C25-L140-Z04-F	●	25	4	25	140	50	1					
AHFM-L003-D25-C25-L140-Z04	●	25	4	25	140	50	1					
AHFM-L003-D25-C25-L180-Z04	●	25	4	25	180	100	1					
AHFM-L003-D26-C25-L250-Z04	●	26	4	25	250	40	1					
AHFM-L003-D32-C32-L200-Z05	●	32	5	32	200	120	1					
AHFM-L003-D33-C32-L250-Z05	●	33	5	32	250	40	1					

R: Sağ / Right / Rechts/ L: Sol / Left / Links

● Stokta / In Stock / Auf Lager ○ Stokta Yok / Non Stock Item / Kein Lagerartikel, Lieferzeit auf Anfrage

KYCR Ucuna Uygundur. / Compatible with KYCR Insert. / Kompatibel mit KYCR Wendeplatten.

F: Eksenel ve Radyal Salgı Değeri 0,02 mm içindedir. / F: Axial and Radial Runout Value is within 0,02 mm.

F: Der axiale und radiale Rundlaufwert liegt innerhalb von 0,02 mm.

Sipariş Örneği/Ordering Example/Bestellbeispiel
1 ad./pcs./stück AEMR-RP10T3K-D32-M16-L43-Z04-H
Kesme Hesabı : S 429 / Cutting Calculation : P 429 / Schnittberechnung : P 429

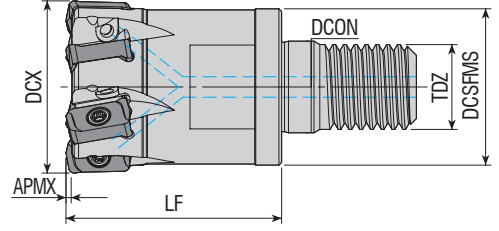

Takım Kodu Ordering Code Bestell-Bezeichnung	Stok Stock Lager	Takım Ölçüleri (mm) Dimension (mm) Abmessung (mm)						Kesici Uç Insert Wendeschneidplatte	Yedek Parçaları / Spare Parts / Ersatzteile				
		DCX	ZEFP	DCSFMS	TDZ	LF	DCON		APMX	Sıkma Vidası Screw Schraube	Baskı Parçası Wedge Clamp Spannpratze	Baskı Vidası Clamp Screw Schraube	Tork Anahtar Torx Key Torx-Schlüssel
AHFM-L003-D20-M10-L30-Z04-H-F	●	20	4	18	M10	30	10.5	1	LOGU 0303..	1108-M3x6.8	-	-	82-T08
AHFM-L003-D25-M12-L35-Z04-H-F	●	25	4	21	M12	35	12.5	1					
AHFM-L003-D25-M12-L35-Z04-H	●	25	4	21	M12	35	12.5	1					
AHFM-L003-D32-M16-L40-Z05-H-F	●	32	5	29	M16	40	17	1					
AHFM-L003-D32-M16-L40-Z05-H	●	32	5	29	M16	40	17	1					
AHFM-L003-D32-M16-L40-Z06-H-F	●	32	6	29	M16	40	17	1					
AHFM-L003-D32-M16-L40-Z06-H	●	32	6	29	M16	40	17	1					
AHFM-L003-D35-M16-L40-Z05-H	●	35	5	29	M16	40	17	1					
AHFM-L003-D35-M16-L40-Z06-H	●	35	6	29	M16	40	17	1					
AHFM-L003-D42-M16-L40-Z05-H	●	42	5	29	M16	40	17	1					
AHFM-L003-D42-M16-L40-Z06-H	●	42	6	29	M16	40	17	1					

F: Eksenel ve Radyal Salgı Değeri 0,02 mm içindedir. / F: Axial and Radial Runout Value is within 0,02 mm.
F: Der axiale und radiale Rundlaufwert liegt innerhalb von 0,02 mm.

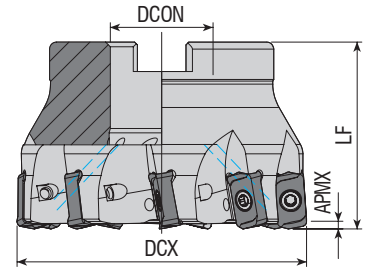

Takım Kodu Ordering Code Bestell-Bezeichnung	Stok Stock Lager	Takım Ölçüleri (mm) Dimension (mm) Abmessung (mm)					Kesici Uç Insert Wendeschneidplatte	Yedek Parçaları / Spare Parts / Ersatzteile		
		DCX	ZEFP	DCON	LF	APMX		Sıkma Vidası Screw Schraube	Tork Anahtar Torx Key Torx-Schlüssel	Montaj Vidası Mounting Screw Befestigungsschraube
AHFM-L003-D040-A16-Z06-H	●	40	6	16	40	1	LOGU 0303..	1108-M3x6.8	82-T08	2506-M8x30
AHFM-L003-D050-A22-Z07-H	●	50	7	22	40	1				2508-M10x30
AHFM-L003-D063-A22-Z09-H	●	63	9	22	40	1				

R: Sağ / Right / Rechts/ L: Sol / Left / Links
● Stokta / In Stock / Auf Lager ○ Stokta Yok / Non Stock Item / Kein Lagerartikel, Lieferzeit auf Anfrage
KYCR Ucuna Uygunur. / Compatible with KYCR Insert. / Kompatibel mit KYCR Wendeplatten.

Sipariş Örneği/Ordering Example/Bestellbeispiel
1 ad./pcs./stück AHFM-L003-D20-M10-L30-Z04-H-F
Kesme Hesabı : S 429 / Cutting Calculation : P 429 / Schnittberechnung : P 429
Sıkma Tork Değeri : S 428 / Tightening Torque : P 428 / Anzugmoment : P 428

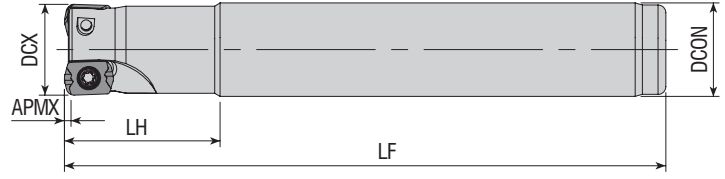

Takım Kodu Ordering Code Bestell-Bezeichnung	Stok Stock Lager	Takım Ölçüleri (mm) Dimension (mm) Abmessung (mm)						Kesici Uç Insert Wendeschneidplatte	Yedek Parçaları / Spare Parts / Ersatzteile		
		DCX	ZEFP	DCON	LF	LH	APMX		Sıkma Vidası Screw Schraube	Tork Anahtar Torx Key Torx-Schlüssel	
AHFM-LP0102-D10-C09-L120-Z02	●	10	2	9	120	20	0.5	LPGT 0102..		3006-M1.8x4	
AHFM-LP0102-D10-C10-L120-Z02	●	10	2	10	120	20	0.5				
AHFM-LP0102-D12-C11-L120-Z02	●	12	2	11	120	20	0.5				
AHFM-LP0102-D12-C12-L120-Z02	●	12	2	12	120	20	0.5				

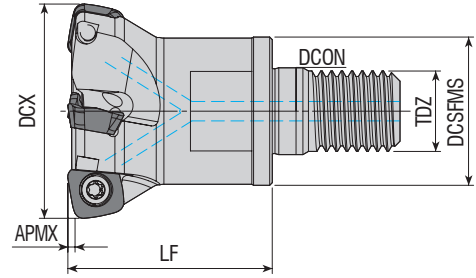

Takım Kodu Ordering Code Bestell-Bezeichnung	Stok Stock Lager	Takım Ölçüleri (mm) Dimension (mm) Abmessung (mm)							Kesici Uç Insert Wendeschneidplatte	Yedek Parçaları / Spare Parts / Ersatzteile			
		DCX	ZEFP	DCSFMS	TDZ	LF	DCON	APMX		Sıkma Vidası Screw Schraube	Baskı Parçası Wedge Clamp Spannpratze	Baskı Vidası Clamp Screw Schraube	Tork Anahtar Torx Key Torx-Schlüssel
AHFM-SO1004-D32-M16-L40-Z03-H	●	32	3	29	M16	40	17	1.5	SOMT 1004..				
AHFM-SO1004-D35-M16-L40-Z03-H	●	35	3	29	M16	40	17	1.5					
AHFM-SO1004-D40-M16-L40-Z04-H	●	40	4	29	M16	40	17	1.5					
AHFM-SO1004-D42-M16-L40-Z04-H	●	42	4	29	M16	40	17	1.5					

R: Sağ / Right / Rechts/ L: Sol / Left / Links

● Stokta / In Stock / Auf Lager ○ Stokta Yok / Non Stock Item / Kein Lagerartikel, Lieferzeit auf Anfrage

KYCR Ucuna Uygundur. / Compatible with KYCR Insert. / Kompatibel mit KYCR Wendeplatten.

Sipariş Örneği/Ordering Example/Bestellbeispiel

1 ad./pcs./stück AHFM-LP0102-D10-C09-L120-Z02

Kesme Hesabı : S 429 / Cutting Calculation : P 429 / Schnittberechnung : P 429

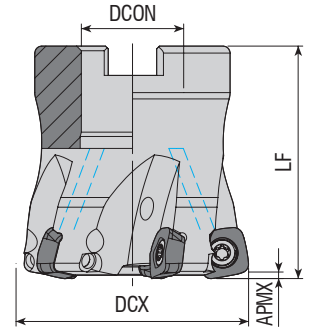

Takım Kodu Ordering Code Bestell-Bezeichnung	Stok Stock Lager	Takım Ölçüleri (mm) Dimension (mm) Abmessung (mm)					Kesici Uç Insert Wendeschneidplatte	Yedek Parçaları / Spare Parts / Ersatzteile		
		DCX	ZEFP	DCON	LF	APMX		Sıkma Vidası Screw Schraube	Tork Anahtar Torx Key Torx-Schlüssel	Montaj Vidası Mounting Screw Befestigungsschraube
AHFM-SO1004-D050-A22-Z05-H	●	50	5	22	50	1.5	SOMT 1004..	4015-M4x11	80-T15	2508-M10x30 2510-M12x35
new AHFM-SO1004-D052-A22-Z05-H	●	52	5	22	50	1.5				
AHFM-SO1004-D063-A22-Z06-H	●	63	6	22	50	1.5				
AHFM-SO1004-D080-A27-Z07-H	●	80	7	27	63	1.5				

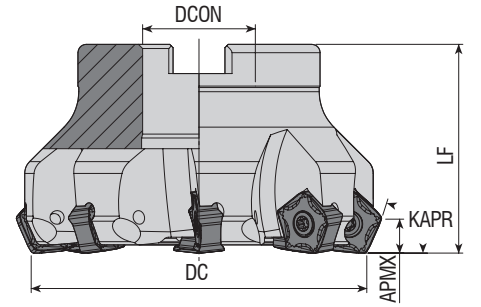

Takım Kodu Ordering Code Bestell-Bezeichnung	Stok Stock Lager	Takım Ölçüleri (mm) Dimension (mm) Abmessung (mm)					Kesici Uç Insert Wendeschneidplatte	Yedek Parçaları / Spare Parts / Ersatzteile		
		DC	ZEFP	DCON	LF	APMX		Sıkma Vidası Screw Schraube	Tork Anahtar Torx Key Torx-Schlüssel	Montaj Vidası Mounting Screw Befestigungsschraube
AFM66-PN0905-D050-A22-Z05	●	50	5	22	40	8	PNMU 0905..	4015-M4x11	80-T15	2508-M10x30 2510-M12x35 2514-M16x35 -
AFM66-PN0905-D063-A22-Z06	●	63	6	22	40	8				
AFM66-PN0905-D080-A27-Z08	●	80	8	27	50	8				
AFM66-PN0905-D100-A32-Z10	●	100	10	32	50	8				
AFM66-PN0905-D125-B40-Z12	●	125	12	40	63	8				

R: Sağ / Right / Rechts L: Sol / Left / Links

● Stokta / In Stock / Auf Lager ○ Stokta Yok / Non Stock Item / Kein Lagerartikel, Lieferzeit auf Anfrage

KYCR Ucuna Uygundur. / Compatible with KYCR Insert. / Kompatibel mit KYCR Wendeplatten.

Sipariş Örneği/Ordering Example/Bestellbeispiel

1 ad./pcs./stück AHFM-SO1004-D050-A22-Z05-H

Kesme Hesabı : S 429 / Cutting Calculation : P 429 / Schnittberechnung : P 429

Montaj Ölçüleri : S 426 / Mounting Reference : P 426 / Montagehinweis : P 426

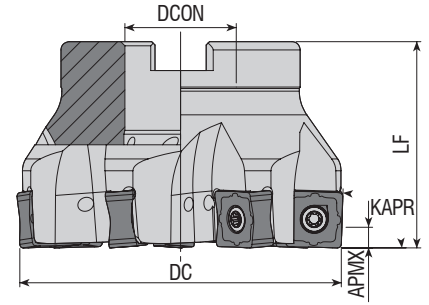
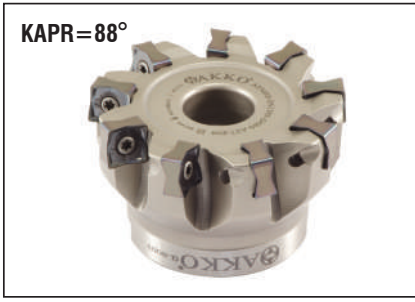

Takım Kodu Ordering Code Bestell-Bezeichnung	Stok Stock Lager	Takım Ölçüleri (mm) Dimension (mm) Abmessung (mm)					Kesici Uç Insert Wendeschneidplatte	Yedek Parçaları / Spare Parts / Ersatzteile		
		DC	ZEFP	DCON	LF	APMX		Sıkma Vidası Screw Schraube	Tork Anahtar Torx Key Torx-Schlüssel	Montaj Vidası Mounting Screw Befestigungsschraube
AFM88-SN1305-D050-A22-Z04	●	50	4	22	40	5	SNMU 1305..	4015-M4x11	80-T15	2508-M10x30
AFM88-SN1305-D050-A22-Z05	●	50	5	22	40	5				
AFM88-SN1305-D063-A22-Z05	●	63	5	22	40	5				
AFM88L-SN1305-D063-A22-Z07	●	63	7	22	40	5				
AFM88-SN1305-D063-A22-Z07	●	63	7	22	40	5				
AFM88-SN1305-D080-A27-Z06	●	80	6	27	50	5				2510-M12x35
AFM88-SN1305-D080-A27-Z09	●	80	9	27	50	5				
AFM88-SN1305-D100-A32-Z07	●	100	7	32	50	5				2514-M16x35
AFM88-SN1305-D100-A32-Z11	●	100	11	32	50	5				
AFM88-SN1305-D125-B40-Z13	●	125	13	40	63	5				-

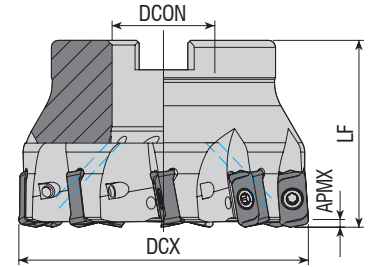

Takım Kodu Ordering Code Bestell-Bezeichnung	Stok Stock Lager	Takım Ölçüleri (mm) Dimension (mm) Abmessung (mm)					Kesici Uç Insert Wendeschneidplatte	Yedek Parçaları / Spare Parts / Ersatzteile		
		DC	ZEFP	DCON	LF	APMX		Sıkma Vidası Screw Schraube	Tork Anahtar Torx Key Torx-Schlüssel	Montaj Vidası Mounting Screw Befestigungsschraube
AFM90-L010-D040-A16-Z05-H	●	40	5	16	40	10	LOMU 1004..	1108-M3x6.8	82-T08	2506-M8x30
AFM90-L010-D050-A22-Z05-H	●	50	5	22	40	10				
AFM90-L010-D063-A22-Z06-H	●	63	6	22	40	10				
AFM90-L01505-D050-A22-Z04-H	●	50	4	22	40	15	LOMU 1505..	3015-M4x11	80-T15	2508-M10x30
AFM90-L01505-D063-A22-Z05-H	●	63	5	22	40	15				

R: Sağ / Right / Rechts L: Sol / Left / Links

● Stokta / In Stock / Auf Lager ○ Stokta Yok / Non Stock Item / Kein Lagerartikel, Lieferzeit auf Anfrage

KYCR Ucuna Uygunudur. / Compatible with KYCR Insert. / Kompatibel mit KYCR Wendeplatten.

Sipariş Örneği/Ordering Example/Bestellbeispiel

1 ad./pcs./stück AFM88-SN1305-D050-A22-Z04

Kesme Hesabı : S 429 / Cutting Calculation : P 429 / Schnittberechnung : P 429

Montaj Ölçüleri : S 426 / Mounting Reference : P 426 / Montagehinweis : P426

KYCR Ucuna Uygundur. / Compatible with KYCR Insert. / Kompatibel mit KYCR Wendeplatten.

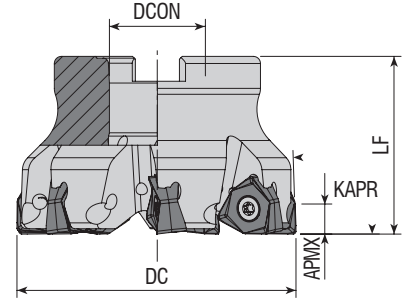
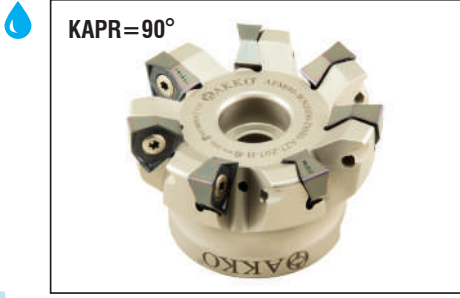

Takım Kodu Ordering Code Bestell-Bezeichnung	Stok Stock Lager	Takım Ölçüleri (mm) Dimension (mm) Abmessung (mm)					Kesici Uç Insert Wendescheidplatte	Yedek Parçaları / Spare Parts / Ersatzteile		
		DC	ZEFP	DCON	LF	APMX		Sıkma Vidası Screw Schraube	Tork Anahtar Torx Key Torx-Schlüssel	Montaj Vidası Mounting Screw Befestigungsschraube
AFM90-WN0806-D050-A16-Z04-H	●	50	4	16	40	8	WNMX 080608		80-T15	2506-M8x30
AFM90-WN0806-D063-A22-Z05-H	●	63	5	22	40	8				2508-M10x30
AFM90-WN0806-D080-A27-Z07-H	●	80	7	27	50	8				2510-M12x35

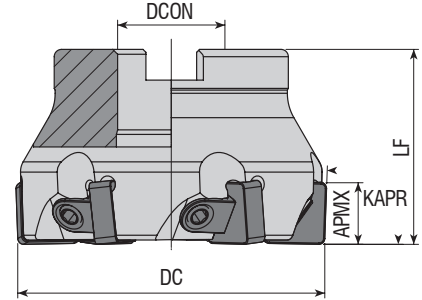

Takım Kodu Ordering Code Bestell-Bezeichnung	Stok Stock Lager	Takım Ölçüleri (mm) Dimension (mm) Abmessung (mm)					Kesici Uç Insert Wendescheidplatte	Yedek Parçaları / Spare Parts / Ersatzteile			
		DC	ZEFP	DCON	LF	APMX		Baskı Parçası Wedge Clamp Spannpratze	Baskı Vidası Clamp Screw Klemmschraube	Anahtar Allen Key Innensechskantschlüssel	Montaj Vidası Mounting Screw Befestigungsschraube
AFM88C-SN1204-D050-A22-Z05	●	50	5	22	40	11	SN.. 1204..				2408-M10x30
AFM88C-SN1204-D063-A22-Z06	●	63	6	22	40	11					2510-M12x35
AFM88C-SN1204-D080-A27-Z07	●	80	7	27	50	11					2514-M16x35
AFM88C-SN1204-D100-A32-Z08	●	100	8	32	50	11					-
AFM88C-SN1204-D125-B40-Z11	●	125	11	40	63	11					-

R: Sağ / Right / Rechts L: Sol / Left / Links

● Stokta / In Stock / Auf Lager ○ Stokta Yok / Non Stock Item / Kein Lagerartikel, Lieferzeit auf Anfrage

KYCR Ucuna Uygundur. / Compatible with KYCR Insert. / Kompatibel mit KYCR Wendeplatten.

Sipariş Örneği/Ordering Example/Bestellbeispiel

1 ad./pcs./stück AFM90-WN0806-D050-A16-Z04-H

Kesme Hesabı : S 429 / Cutting Calculation : P 429 / Schnittberechnung : P 429

LMN Ucuna Uygundur. / Compatible with LMN Insert. / Kompatibel mit LMN Wendeplatten.

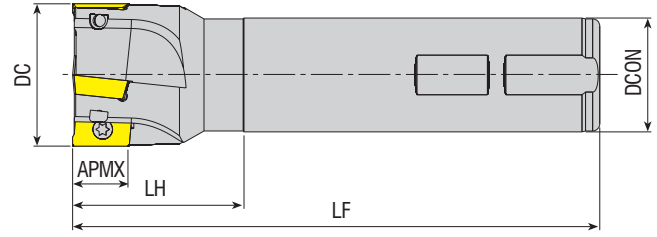

Takım Kodu Ordering Code Bestell-Bezeichnung	Stok Stock Lager	Takım Ölçüleri (mm) Dimension (mm) Abmessung (mm)						Kesici Uç Insert Wendeschneidplatte	Yedek Parçaları / Spare Parts / Ersatzteile	
		DC	ZEPF	DCON	LF	LH	APMX		Sıkma Vidası Screw Schraube	Tork Anahtar Torx Key Torx-Schlüssel
AEM90-AP16L-D25-C25-L120-Z02-H	●	25	2	25	120	45	16	AP. 1604..	4015-M4x9	80-T15
AEM90-AP16L-D25-C25-L150-Z02	●	25	2	25	150	55	16			
AEM90-AP16L-D25-C25-L200-Z02	●	25	2	25	200	55	16			
AEM90-AP16L-D25-C25-L250-Z02	●	25	2	25	250	100	16			
AEM90-AP16L-D30-W25-L120-Z03-H	●	30	3	25	120	40	16			
AEM90-AP16L-D32-C32-L120-Z03-H	●	32	3	32	120	45	16			
AEM90-AP16L-D32-C32-L150-Z03	●	32	3	32	150	55	16			
AEM90-AP16L-D32-C32-L200-Z03	●	32	3	32	200	55	16			
AEM90-AP16L-D32-C32-L250-Z03	●	32	3	32	250	100	16			
AEM90-AP16L-D40-C32-L120-Z04-H	●	40	4	32	120	40	16			
AEM90-AP16L-D40-C32-L150-Z04	●	40	4	32	150	40	16			
AEM90-AP16L-D40-C32-L200-Z04	●	40	4	32	200	40	16			
AEM90-AP16L-D40-C32-L250-Z04	●	40	4	32	250	40	16			
AEM90-AP1705-D25-C25-L120-Z02	●	25	2	25	120	40	16	AP. 1705..		
AEM90-AP1705-D26-C25-L200-Z02	●	26	2	25	200	40	16			
AEM90-AP1705-D26-C25-L250-Z02	●	26	2	25	250	40	16			
AEM90-AP1705-D26-C25-L300-Z02	○	26	2	25	300	40	16			
AEM90-AP1705-D28-W25-L075-Z02	●	28	2	25	75	20	16			
AEM90-AP1705-D32-C25-L150-Z03	●	32	3	25	150	40	16			
AEM90-AP1705-D33-C32-L250-Z03	●	33	3	32	250	40	16			
AEM90-AP1705-D33-C32-L300-Z02	●	33	2	32	300	40	16			

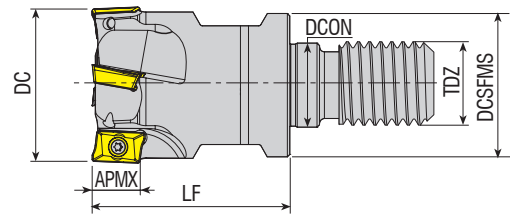

Takım Kodu Ordering Code Bestell-Bezeichnung	Stok Stock Lager	Takım Ölçüleri (mm) Dimension (mm) Abmessung (mm)							Kesici Uç Insert Wendeschneidplatte	Yedek Parçaları / Spare Parts / Ersatzteile	
		DC	ZEPF	DCSFMS	TDZ	LF	DCON	APMX		Sıkma Vidası Screw Schraube	Tork Anahtar Torx Key Torx-Schlüssel
AEM90-AP16L-D25-M12-L43-Z02-H	●	25	2	21	M12	43	12.5	16	AP. 1604..	4015-M4x9	80-T15
AEM90-AP16L-D32-M16-L43-Z03-H	●	32	3	29	M16	43	17	16			
AEM90-AP16L-D40-M16-L43-Z04-H	●	40	4	29	M16	43	17	16			

R: Sağ / Right / Rechts L: Sol / Left / Links

● Stokta / In Stock / Auf Lager ○ Stokta Yok / Non Stock Item / Kein Lagerartikel, Lieferzeit auf Anfrage

LMN Ucuna Uygundur. / Compatible with LMN Insert. / Kompatibel mit LMN Wendeplatten.

Sipariş Örneği/Ordering Example/Bestellbeispiel

1 ad./pcs./stück AEM90-AP16L-D25-C25-L120-Z02-H

Kesme Hesabı : S 429 / Cutting Calculation : P 429 / Schnittberechnung : P 429

Sıkma Tork Değeri : S 428 / Tightening Torque : P 428 / Anzugmoment : P 428

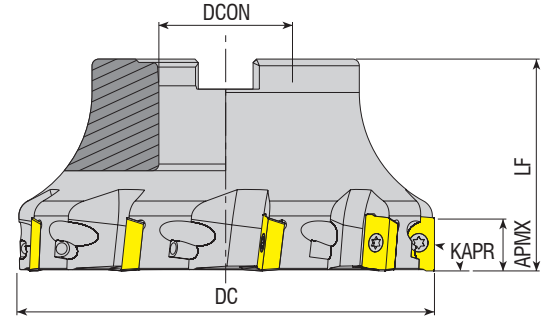

Takım Kodu Ordering Code Bestell-Bezeichnung	Stok Stock Lager	Takım Ölçüleri (mm) Dimension (mm) Abmessung (mm)					Kesici Uç Insert Wendeschneidplatte	Yedek Parçaları / Spare Parts / Ersatzteile			
		DC	ZEFP	DCON	LF	APMX		Sıkma Vidası Screw Schraube	Tork Anahtar Torx Key Torx-Schlüssel	Montaj Vidası Mounting Screw Befestigungsschraube	
AFM90-AP16L-D050-A22-Z05-H	●	50	5	22	40	16	AP. 1604..				2508-M10x30
AFM90-AP16L-D063-A22-Z06-H	●	63	6	22	40	16					
AFM90-AP16L-D080-A27-Z07-H	●	80	7	27	50	16					

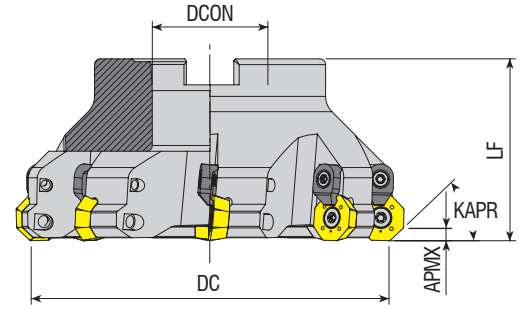

Takım Kodu Ordering Code Bestell-Bezeichnung	Stok Stock Lager	Takım Ölçüleri (mm) Dimension (mm) Abmessung (mm)					Kesici Uç Insert Wendeschneidplatte	Yedek Parçaları / Spare Parts / Ersatzteile									
		DC	ZEFP	DCON	LF	APMX		Sıkma Vidası Screw Schraube	Baskı Parçası Wedge Clamp Spannpratze	Baskı Vidası Clamp Screw Klemmschraube	Tork Anahtar Torx Key Torx-Schlüssel	Montaj Vidası Mounting Screw Befestigungsschraube					
AFM43C-OD0605-D080-A27-Z06-H	●	80	6	27	50	4	OD.. 0605..										
AFM43C-OD0605-D100-A32-Z07-H	●	100	7	32	50	4							1020-M5x11	ACK-05	4015-M4x11	80-T20	2510-M12x35
AFM43C-OD0605-D125-B40-Z08	●	125	8	40	63	4							-	-	-	-	-

R: Sağ / Right / Rechts/ L: Sol / Left / Links

● Stokta / In Stock / Auf Lager ○ Stokta Yok / Non Stock Item / Kein Lagerartikel, Lieferzeit auf Anfrage

LMN Ucuna Uygundur. / Compatible with LMN Insert. / Kompatibel mit LMN Wendeplatten.

Sipariş Örneği/Ordering Example/Bestellbeispiel

1 ad./pcs./stück AFM90-AP16L-D050-A22-Z05-H

Kesme Hesabı : S 429 / Cutting Calculation : P 429 / Schnittberechnung : P 429

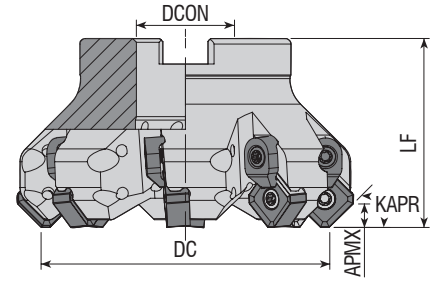

Takım Kodu
Ordering Code
Bestell-Bezeichnung

Stok Stock Lager	Takım Ölçüleri (mm) Dimension (mm) Abmessung (mm)					Kesici Uç Insert Wendeschneidplatte	Yedek Parçaları / Spare Parts / Ersatzteile				
	DC	ZEFP	DCON	LF	APMX		Sıkma Vidası Screw Schraube	Baskı Parçası Wedge Clamp Spannpratze	Baskı Vidası Clamp Screw Klemmschraube	Tork Anahtar Torx Key Torx-Schlüssel	Montaj Vidası Mounting Screw Befestigungsschraube
●	50	4	22	42	6	SN.. 12..	1015-M4x11	ACK-05	4015-M4x11	80-T15	2407-M10x30
●	50	5	22	42	6						
●	63	6	22	42	6						
●	63	7	22	42	6						
●	63	7	22	42	6						
●	80	7	27	52	6						
●	80	8	27	52	6						
●	80	8	27	52	6						
●	100	8	32	52	6						
●	100	10	32	52	6						
●	100	10	32	52	6						
●	125	11	40	65	6						
●	125	11	40	65	6						
●	160	12	40	65	6						
●	200	14	60	65	6						
●	200	14	60	65	6						

R: Sağ / Right / Rechts L: Sol / Left / Links

● Stokta / In Stock / Auf Lager ○ Stokta Yok / Non Stock Item / Kein Lagerartikel, Lieferzeit auf Anfrage

LMN Ucuna Uygundur. / Compatible with LMN Insert. / Kompatibel mit LMN Wendeplatten.

Sipariş Örneği/Ordering Example/Bestellbeispiel

1 ad./pcs./stück AFM43C-OD0605-D080-A27-Z06-H

Kesme Hesabı : S 429 / Cutting Calculation : P 429 / Schnittberechnung : P 429

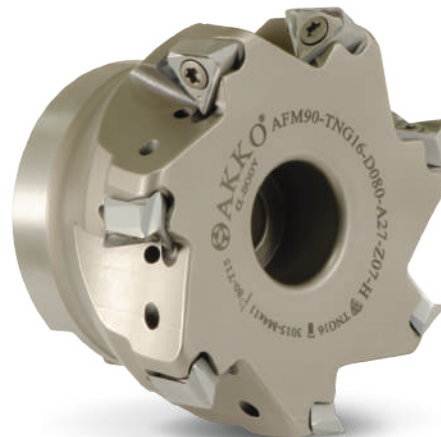

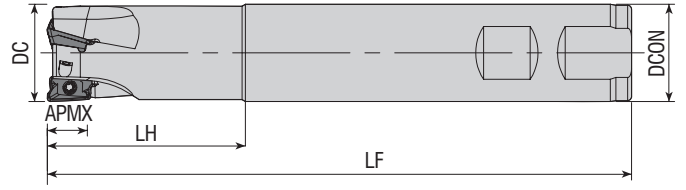

Takım Kodu Ordering Code Bestell-Bezeichnung	Stok Stock Lager	Takım Ölçüleri (mm) Dimension (mm) Abmessung (mm)						Kesici Uç Insert Wendeschneidplatte	Yedek Parçaları / Spare Parts / Ersatzteile		
		DC	ZEPF	DCON	LF	LH	APMX		Sıkma Vidası Screw Schraube	Tork Anahtar Torx Key Torx-Schlüssel	
AEM90-AO1236-D16-W16-L150-Z02	●	16	2	16	150	50	10	AO..1236..	3008-M2.5x6	82-T08	
AEM90-AO1236-D16-C16-L160-Z02-H	●	16	2	16	160	25	10				
AEM90-AO1236-D17-C16-L150-Z02-H	●	17	2	16	150	25	10				
AEM90-AO1236-D18-C16-L160-Z02-H	●	18	2	16	160	25	10				
AEM90-AO1236-D20-C20-L160-Z03-H	●	20	3	20	160	30	10				
AEM90-AO1236-D20-C20-L100-Z02	●	20	2	20	100	30	10				
AEM90-AO1236-D21-C20-L220-Z03-H	●	21	3	20	220	30	10				
AEM90-AO1236-D22-C20-L160-Z03-H	●	22	3	20	160	30	10				
AEM90-AO1236-D25-C25-L115-Z02	●	25	2	25	150	50	10				
AEM90-AO1236-D25-C25-L160-Z04-H	●	25	4	25	160	50	10				
AEM90-AO1236-D25-W25-L150-Z03	●	25	3	25	150	50	10				
AEM90-AO1236-D26-C25-L150-Z04-H	●	26	4	25	150	35	10				
AEM90-AO1236-D26-C25-L160-Z04-H	●	26	4	25	160	35	10				
AEM90-AO1236-D32-W32-L150-Z04	●	32	4	32	150	50	10				
AEM90-AO1236-D32-C32-L160-Z05-H	●	32	5	32	160	50	10				

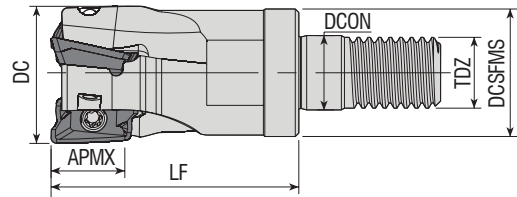
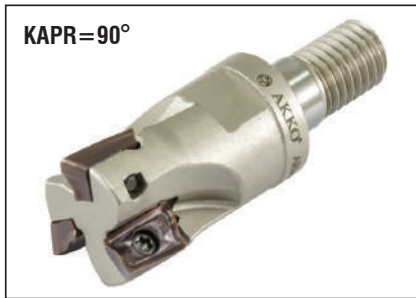

Takım Kodu Ordering Code Bestell-Bezeichnung	Stok Stock Lager	Takım Ölçüleri (mm) Dimension (mm) Abmessung (mm)							Kesici Uç Insert Wendeschneidplatte	Yedek Parçaları / Spare Parts / Ersatzteile		
		DC	Z	DCSFMS	TDZ	LF	DCON	APMX		Sıkma Vidası Screw Schraube	Tork Anahtar Torx Key Torx-Schlüssel	
AEM90-AO1236-D16-M08-L30-Z02	●	16	2	14.8	M08	30	8.5	10	AO.. 1236..	3008-M2.5x6	82-T08	
AEM90-AO1236-D20-M10-L35-Z03	●	20	3	18	M10	35	10.5	10				

R: Sağ / Right / Rechts/ L: Sol / Left / Links

● Stokta / In Stock / Auf Lager ○ Stokta Yok / Non Stock Item / Kein Lagerartikel, Lieferzeit auf Anfrage

MTSBH Ucuna Uygundur. / Compatible with MTSBH Insert. / Kompatibel mit MTSBH Wendeplatten.

Sipariş Örneği/Ordering Example/Bestellbeispiel

1 ad./pcs./stück AEM90-AO1236-D16-W16-L150-Z02

Kesme Hesabı : S 429 / Cutting Calculation : P 429 / Schnittberechnung : P 429

MTSBH Ucuna Uygundur. / Compatible with MTSBH Insert. / Kompatibel mit MTSBH Wendeplatten.

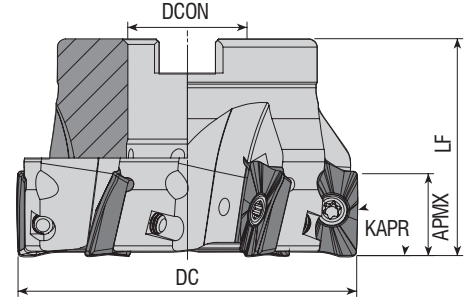

Takım Kodu Ordering Code Bestell-Bezeichnung	Stok Stock Lager	Takım Ölçüleri (mm) Dimension (mm) Abmessung (mm)					Kesici Uç Insert Wendeschneidplatte	Yedek Parçaları / Spare Parts / Ersatzteile		
		DC	ZEFP	DCON	LF	APMX		Sıkma Vidası Screw Schraube	Tork Anahtar Torx Key Torx-Schlüssel	Montaj Vidası Mounting Screw Befestigungsschraube
AFM90-A01236-D050-A22-Z05-H	●	50	5	22	40	10				
AFM90-A01848-D050-A22-Z05-H	●	50	5	22	40	15	AO.. 1236..	3008-M2.5x6	82-T08	2508-M10x30
AFM90-A01848-D063-A22-Z06-H	●	63	6	22	40	15				

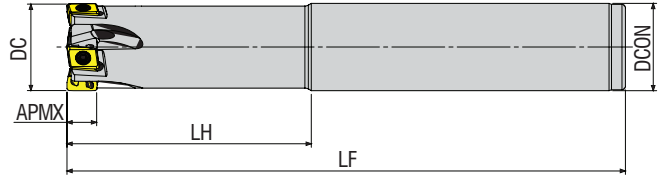

Takım Kodu Ordering Code Bestell-Bezeichnung	Stok Stock Lager	Takım Ölçüleri (mm) Dimension (mm) Abmessung (mm)						Kesici Uç Insert Wendeschneidplatte	Yedek Parçaları / Spare Parts / Ersatzteile	
		DC	ZEFP	DCON	LF	LH	APMX		Sıkma Vidası Screw Schraube	Tork Anahtar Torx Key Torx-Schlüssel
AEM90-L00904-D16-C16-L160-Z02-H	○	16	2	16	160	60	8			
AEM90-L00904-D18-C16-L160-Z02-H	○	18	2	16	160	25	8			
AEM90-L00904-D20-C20-L160-Z03-H	○	20	3	20	160	60	8			
AEM90-L00904-D20-W20-L100-Z03-H	●	20	3	20	100	30	8			
AEM90-L00904-D22-C20-L160-Z03-H	○	22	3	20	160	30	8			
AEM90-L00904-D25-C25-L160-Z04-H	○	25	4	25	160	70	8			
AEM90-L00904-D25-W25-L091-Z03-H	●	25	3	25	91	30	8			
AEM90-L00904-D32-C32-L160-Z05-H	●	32	5	32	160	70	8	3007-M2.7x8	82-T07	

R: Sağ / Right / Rechts/ L: Sol / Left / Links

● Stokta / In Stock / Auf Lager ○ Stokta Yok / Non Stock Item / Kein Lagerartikel, Lieferzeit auf Anfrage

MTSBH Ucuna Uygundur. / Compatible with MTSBH Insert. / Kompatibel mit MTSBH Wendeplatten.

Sipariş Örneği/Ordering Example/Bestellbeispiel

1 ad./pcs./stück AFM90-A01236-D050-A22-Z05-H

Kesme Hesabı : S 429 / Cutting Calculation : P 429 / Schnittberechnung : P 429

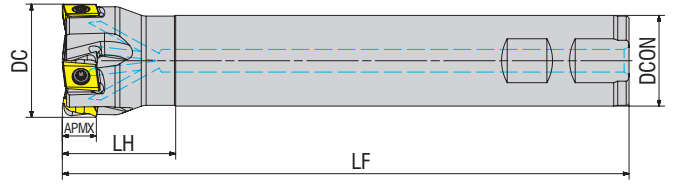

Takım Kodu Ordering Code Bestell-Bezeichnung	Stok Stock Lager	Takım Ölçüleri (mm) Dimension (mm) Abmessung (mm)						Kesici Uç Insert Wendeschneidplatte	Yedek Parçaları / Spare Parts / Ersatzteile		
		DCX	ZEFP	DCON	LF	LH	APMX		Sıkma Vidası Screw Schraube	Tork Anahtar Torx Key Torx-Schlüssel	
AEM90-L01207-D32-W32-L105-Z03-H	○	32	3	32	105	45	11	LOGU 1207..		3015-M4x11	80-T15
AEM90-L01207-D40-W32-L200-Z04-H	○	40	4	32	200	40	11				

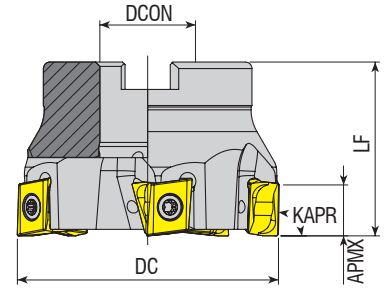

Takım Kodu Ordering Code Bestell-Bezeichnung	Stok Stock Lager	Takım Ölçüleri (mm) Dimension (mm) Abmessung (mm)					Kesici Uç Insert Wendeschneidplatte	Yedek Parçaları / Spare Parts / Ersatzteile			
		DC	ZEFP	DCON	LF	APMX		Sıkma Vidası Screw Schraube	Tork Anahtar Torx Key Torx-Schlüssel	Montaj Vidası Mounting Screw Befestigungsschraube	
AFM90-L00904-D040-A16-Z06-H	●	40	6	16	40	8	LOGU 0904..			2506-M8x30	
AFM90-L00904-D050-A22-Z05-H	●	50	5	22	40	8				82-T07	2508-M10x30
AFM90-L00904-D050-A22-Z07-H	●	50	7	22	40	8					
AFM90-L00904-D063-A22-Z06-H	●	63	6	22	40	8					
AFM90-L01207-D040-A16-Z04-H	●	40	4	16	40	11	LOGU 1207..			2506-M8x30	
AFM90-L01207-D050-A22-Z05-H	●	50	5	22	40	11				2508-M10x30	
AFM90-L01207-D063-A22-Z05-H	●	63	5	22	40	11				2510-M12x35	
AFM90-L01207-D063-A22-Z06-H	●	63	6	22	40	11				2514-M16x35	
AFM90-L01207-D080-A27-Z07-H	●	80	7	27	50	11					
AFM90-L01207-D100-A32-Z07-H	●	100	7	32	50	11					

R: Sağ / Right / Rechts/ L: Sol / Left / Links

● Stokta / In Stock / Auf Lager ○ Stokta Yok / Non Stock Item / Kein Lagerartikel, Lieferzeit auf Anfrage

MTSBH Ucuna Uygundur. / Compatible with MTSBH Insert. / Kompatibel mit MTSBH Wendeplatten.

Sipariş Örneği/Ordering Example/Bestellbeispiel

1 ad./pcs./stück AEM90-L01207-D32-W32-L105-Z03-H

Kesme Hesabı : S 429 / Cutting Calculation : P 429 / Schnittberechnung : P 429

Sıkma Tork Değeri : S 428 / Tightening Torque : P 428 / Anzugsmoment : P 428

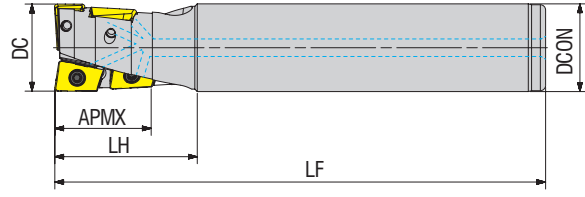

Takım Kodu Ordering Code Bestell-Bezeichnung	Stok Stock Lager	Takım Ölçüleri (mm) Dimension (mm) Abmessung (mm)						Kesici Uç Insert Wendeschnidplatte	Yedek Parçaları / Spare Parts / Ersatzteile		
		DCX	ZEFP	DCON	LF	LH	APMX		Sıkma Vidası Screw Schraube	Tork Anahtar Torx Key Torx-Schlüssel	
ADM90-Q010-D20-C20-L130-Z0204-H	○	20	4-2	20	130	35	"	QOMT 1035R-M2	3008-M2.5x6	82-T08	
ADM90-Q010-D20-C20-L185-Z0204-H	○	20	4-2	20	185	60	22				
ADM90-Q013-D25-C25-L140-Z0204-H	○	25	4-2	25	140	40	27.5	QOMT 1342R-M2	3008-M3x6		
ADM90-Q013-D25-C25-L220-Z0204-H	○	25	4-2	25	220	75	27.5				
ADM90-Q016-D32-C32-L150-Z0204-H	○	32	4-2	32	150	50	35	QOMT 1651R-M2	4015-M4x9	80-T15	
ADM90-Q016-D32-C32-L200-Z02-H	○	32	2	32	200	50	14.5				
ADM90-Q016-D32-C32-L230-Z0204-H	○	32	4-2	32	230	90	35				
ADM90-Q016-D32-C32-L230-Z02-H	○	32	2	32	230	50	14.5				
ADM90-Q020-D40-C32-L160-Z0204	○	40	4-2	32	160	60	44	QOMT 2062R-M2	1120-M5x11	80-T20	
ADM90-Q020-D40-C32-L240-Z0204	○	40	4-2	32	240	60	44				

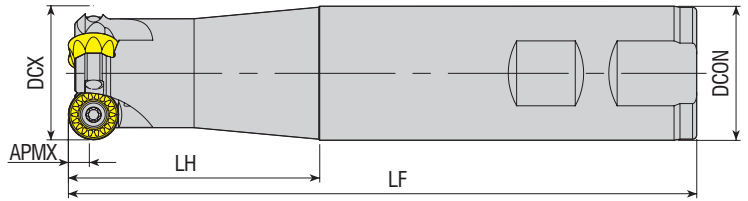

Takım Kodu Ordering Code Bestell-Bezeichnung	Stok Stock Lager	Takım Ölçüleri (mm) Dimension (mm) Abmessung (mm)						Kesici Uç Insert Wendeschnidplatte	Yedek Parçaları / Spare Parts / Ersatzteile			
		DCX	ZEFP	DCON	LF	LH	APMX		Sıkma Vidası Screw Schraube	Baskı Parçası Wedge Clamp Spannpratze	Baskı Vidası Clamp Screw Schraube	Tork Anahtar Torx Key Torx-Schlüssel
AEMR-RP08T2M-D20-W20-L150-Z02-H	●	20	2	20	150	60	4	RPMT 08T2..	3008-M2.5x6	-	-	82-T08
AEMR-RP08T2M-D25-W25-L200-Z03-H	●	25	3	25	200	100	4					
AEMR-RP10T3M-D25-W25-L200-Z02-H	●	25	2	25	200	100	5	RPMT 10T3..	4015-M3.5x9	-	-	
AEMR-RP10T3M-D32-W32-L200-Z03-H	●	32	3	32	200	100	5					
AEMR-RP1204M-D25-C25-L180-Z02	●	25	2	25	180	50	6	RPMT 1204..	4015-M4x9	-	-	80-T15
AEMR-RP1204M-D25-C25-L180-Z02-H	●	25	2	25	180	50	6					
AEMR-RP1204M-D32-W32-L150-Z03-H	●	32	3	32	150	60	6					
AEMR-RP1204M-D32-W32-L200-Z03-H	●	32	3	32	200	100	6					
AEMR-RP1204M-D36-C25-L160-Z03	●	36	3	25	160	30	3	RPMT 1606..	1020-M5x11	-	-	80-T20
AEMR-RP1606M-D40-W32-L150-Z02-H	●	40	2	16	150	35	8					
AEMR-RP1606M-D40-W32-L200-Z02-H	●	40	2	16	200	35	8					

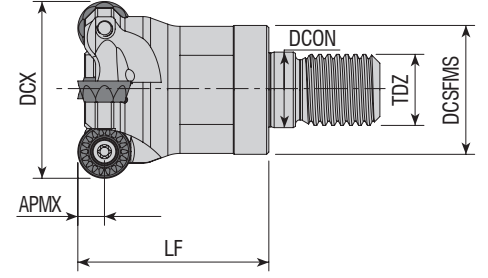

Takım Kodu Ordering Code Bestell-Bezeichnung	Stok Stock Lager	Takım Ölçüleri (mm) Dimension (mm) Abmessung (mm)						Kesici Uç Insert Wendeschneidplatte	Yedek Parçaları / Spare Parts / Ersatzteile		
		DCX	ZEFP	DCSFMS	TDZ	LF	DCON		APMX	Sıkma Vidası Screw Schraube	Tork Anahtar Torx Key Torx-Schlüssel
AEMR-RP08T2M-D20-M10-L30-Z02-H	●	20	2	18	M10	30	10.5	4			
AEMR-RP10T3M-D25-M12-L35-Z02-H	●	25	2	21	M12	35	12.5	5	RPMT 10T3..	4015-M3.5x9	80-T15
AEMR-RP10T3M-D32-M16-L43-Z03-H	●	32	3	29	M16	43	17	5			
AEMR-RP1204M-D32-M16-L43-Z03-H	●	32	3	29	M16	43	17	6	RPMT 1204..	4015-M4x9	
AEMR-RP1204M-D40-M16-L43-Z04-H	●	40	4	29	M16	43	17	6			

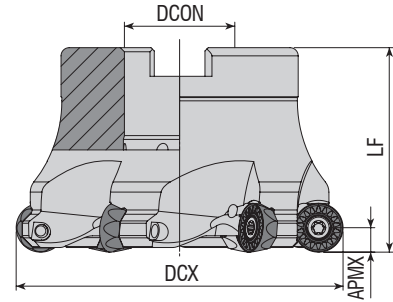

Takım Kodu Ordering Code Bestell-Bezeichnung	Stok Stock Lager	Takım Ölçüleri (mm) Dimension (mm) Abmessung (mm)					Kesici Uç Insert Wendeschneidplatte	Yedek Parçaları / Spare Parts / Ersatzteile			
		DCX	ZEFP	DCON	LF	APMX		Sıkma Vidası Screw Schraube	Tork Anahtar Torx Key Torx-Schlüssel	Montaj Vidası Mounting Screw Befestigungsschraube	
new AFMR-RP1204M-D040-A16-Z04-H	●	40	4	16	40	-	RPMT 1204..			2406-M8x30	
AFMR-RP1204M-D042-A16-Z04-H	●	42	4	16	40	6				2508-M10x30	
AFMR-RP1204M-D050-A22-Z04-H	●	50	4	22	50	6				2510-M12x35	
AFMR-RP1204M-D052-A22-Z05-H	●	52	5	22	50	6					
AFMR-RP1204M-D063-A22-Z05-H	●	63	5	22	50	6					
AFMR-RP1204M-D080-A27-Z06-H	●	80	6	27	50	6					

R: Sağ / Right / Rechts L: Sol / Left / Links

● Stokta / In Stock / Auf Lager ○ Stokta Yok / Non Stock Item / Kein Lagerartikel, Lieferzeit auf Anfrage

MTSBH Ucuna Uygundur. / Compatible with MTSBH Insert. / Kompatibel mit MTSBH Wendeplatten.

Sipariş Örneği/Ordering Example/Bestellbeispiel

1 ad./pcs./stück AEMR-RP08T2M-D20-M10-L30-Z02-H

Kesme Hesabı : S 429 / Cutting Calculation : P 429 / Schnittberechnung : P 429

Montaj Ölçüleri : S 426 / Mounting Reference : P 426 / Montagehinweis : P 426

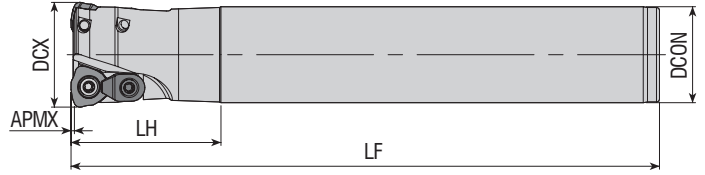

Takım Kodu Ordering Code Bestell-Bezeichnung	Stok Stock Lager	Takım Ölçüleri (mm) Dimension (mm) Abmessung (mm)						Kesici Uç Insert Wendeschneidplatte	Yedek Parçaları / Spare Parts / Ersatzteile			
		DCX	ZEFP	DCON	LF	LH	APMX		Sıkma Vidası Screw Schraube	Baskı Parçası Wedge Clamp Spannpratze	Baskı Vidası Clamp Screw Schraube	Tork Anahtar Torx Key Torx-Schlüssel
AHFMC-JD1204-D32-C32-L150-Z02	●	32	2	32	150	50	1	JDMW 1204..				
AHFMC-JD1204-D32-C32-L200-Z02	●	32	2	32	200	50	1					
AHFMC-JD1204-D35-C32-L200-Z02	●	35	2	32	200	50	1					
AHFMC-JD1204-D35-C32-L250-Z02	●	35	2	32	250	50	1					

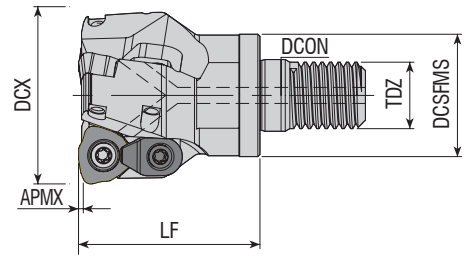

Takım Kodu Ordering Code Bestell-Bezeichnung	Stok Stock Lager	Takım Ölçüleri (mm) Dimension (mm) Abmessung (mm)						Kesici Uç Insert Wendeschneidplatte	Yedek Parçaları / Spare Parts / Ersatzteile				
		DCX	ZEFP	DCSFMS	TDZ	LF	DCON		APMX	Sıkma Vidası Screw Schraube	Baskı Parçası Wedge Clamp Spannpratze	Baskı Vidası Clamp Screw Schraube	Tork Anahtar Torx Key Torx-Schlüssel
AHFMC-JD1204-D32-M16-L43-Z02-H	●	32	2	29	M16	43	17	1.5	JDMW 1204..				
AHFMC-JD1204-D42-M16-L43-Z03-H	●	42	3	29	M16	43	17	1.5					

R: Sağ / Right / Rechts/ L: Sol / Left / Links

● Stokta / In Stock / Auf Lager ○ Stokta Yok / Non Stock Item / Kein Lagerartikel, Lieferzeit auf Anfrage

MTSBH Ucuna Uygundur. / Compatible with MTSBH Insert. / Kompatibel mit MTSBH Wendeplatten.

Sipariş Örneği/Ordering Example/Bestellbeispiel

1 ad./pcs./stück AHFMC-JD1204-D32-C32-L150-Z02

Kesme Hesabı : S 429 / Cutting Calculation : P 429 / Schnittberechnung : P 429

Sıkma Tork Değeri : S 428 / Tightening Torque : P 428 / Anzugsmoment : P 428

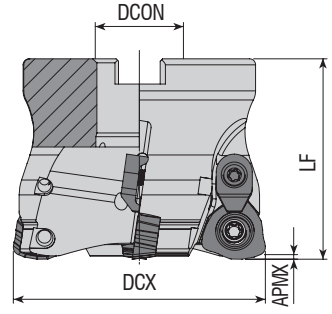

Takım Kodu Ordering Code Bestell-Bezeichnung	Stok Stock Lager	Takım Ölçüleri (mm) Dimension (mm) Abmessung (mm)					Kesici Uç Insert Wendeschneidplatte	Yedek Parçaları / Spare Parts / Ersatzteile				
		DCX	ZEP	DCON	LF	APMX		Sıkma Vidası Screw Schraube	Baskı Pabucu Wedge Clamp Spannpratze	Baskı Vidası Clamp Screw Klemmschraube	Tork Anahtar Torx Key Torx-Schlüssel	Montaj Vidası Mounting Screw Befestigungsschraube
AHFMC-JD1204-D052-A22-Z03-H	●	52	3	22	50	1.5	JDMW 1204..	4615-M4x11	ACK-05	4015-M4x11	80-T15	2508-M10x30
AHFMC-JD1204-D052-A22-Z04-H	●	52	4	22	50	1.5						
AHFMC-JD1204-D063-A22-Z05-H	●	63	5	22	50	1.5						
AHFMC-JD1204-D080-A27-Z06-H	●	80	6	27	50	1.5						
AHFMC-JD1204-D100-A32-Z07-H	●	100	7	32	50	1.5						
AHFMC-JD1405-D052-A22-Z03-H	●	52	3	22	50	2						
AHFMC-JD1405-D063-A22-Z04-H	●	63	4	22	50	2	2508-M10x30					

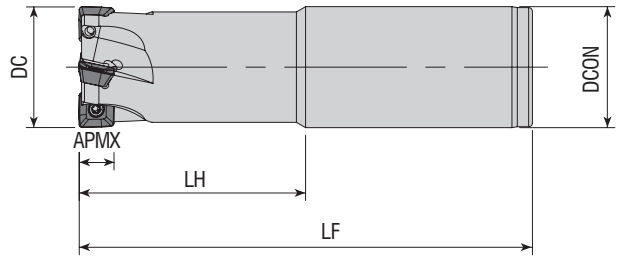

Takım Kodu Ordering Code Bestell-Bezeichnung	Stok Stock Lager	Takım Ölçüleri (mm) Dimension (mm) Abmessung (mm)						Kesici Uç Insert Wendeschneidplatte	Yedek Parçaları / Spare Parts / Ersatzteile	
		DCX	ZEP	DCON	LF	LH	APMX		Sıkma Vidası Screw Schraube	Tork Anahtar Torx Key Torx-Schlüssel
AHFM-SP0735-D16-C16-L160-Z02-H	●	16	2	16	160	30	1.2	SPMX 073505	3108-M3x6	82-T08
AHFM-SP0735-D17-C16-L160-Z02-H	●	17	2	16	160	30	1.2			
AHFM-SP0735-D20-C20-L160-Z03-H	●	20	2	20	160	30	1.2			
AHFM-SP0735-D21-C20-L160-Z03-H	●	21	2	20	160	30	1.2			

R: Sağ / Right / Rechts L: Sol / Left / Links

● Stokta / In Stock / Auf Lager ○ Stokta Yok / Non Stock Item / Kein Lagerartikel, Lieferzeit auf Anfrage

MTSBH Ucuna Uygundur. / Compatible with MTSBH Insert. / Kompatibel mit MTSBH Wendeplatten.

Sipariş Örneği/Ordering Example/Bestellbeispiel

1 ad./pcs./stück AHFMC-JD1204-D052-A22-Z03-H

Kesme Hesabı : S 429 / Cutting Calculation : P 429 / Schnittberechnung : P 429

Montaj Ölçüleri : S 426 / Mounting Reference : P 426 / Montagehinweis : P426

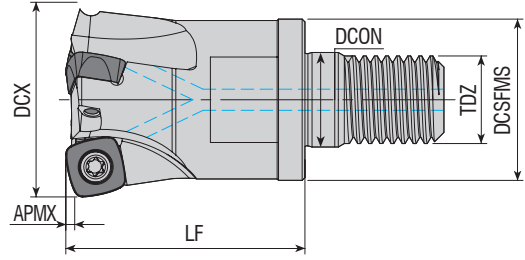

Takım Kodu Ordering Code Bestell-Bezeichnung	Stok Stock Lager	Takım Ölçüleri (mm) Dimension (mm) Abmessung (mm)							Kesici Uç Insert Wendeschneidplatte	Yedek Parçaları / Spare Parts / Ersatzteile		
		DCX	ZEFP	DC SFMS	TDZ	LF	DCON	APMX		Sıkma Vidası Screw Schraube	Tork Anahtar Torx Key Torx-Schlüssel	
AHFM-SP0735-D16-M08-L23-Z02-H	●	16	2	14.75	M08	23	8.5	1.2	SPMX 073505	3108-M3x6	82-T08	
AHFM-SP0735-D20-M10-L30-Z03-H	●	20	3	18	M10	30	10.5	1.2				
AHFM-SP0735-D25-M12-L35-Z04-H	●	25	4	21	M12	35	12.5	1.2				

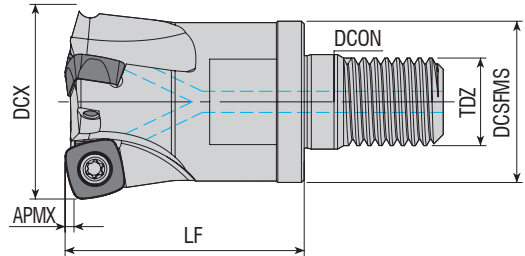

Takım Kodu Ordering Code Bestell-Bezeichnung	Stok Stock Lager	Takım Ölçüleri (mm) Dimension (mm) Abmessung (mm)							Kesici Uç Insert Wendeschneidplatte	Yedek Parçaları / Spare Parts / Ersatzteile		
		DCX	ZEFP	DC SFMS	TDZ	LF	DCON	APMX		Sıkma Vidası Screw Schraube	Tork Anahtar Torx Key Torx-Schlüssel	
AHFM-SP0945-D32-M16-L43-Z04-H	●	32	4	29	M16	43	17	1.4	SPMX 094506	4115-M4x8	80-T15	
AHFM-SP0945-D35-M16-L43-Z04-H	●	35	4	29	M16	43	17	1.4				
AHFM-SP0945-D42-M16-L43-Z05-H	●	42	5	29	M16	43	17	1.4				

R: Sağ / Right / Rechts/ L: Sol / Left / Links

● Stokta / In Stock / Auf Lager ○ Stokta Yok / Non Stock Item / Kein Lagerartikel, Lieferzeit auf Anfrage

MTSBH Ucuna Uygundur. / Compatible with MTSBH Insert. / Kompatibel mit MTSBH Wendeplatten.

Sipariş Örneği/Ordering Example/Bestellbeispiel
1 ad./pcs./stück AHFM-SP0735-D16-M08-L23-Z02-H
Kesme Hesabı : S 429 / Cutting Calculation : P 429 / Schnittberechnung : P 429

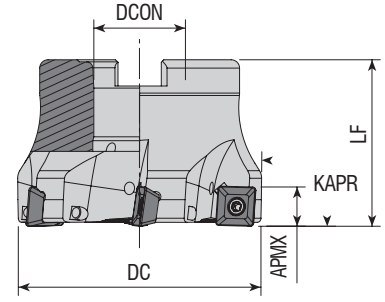

Takım Kodu Ordering Code Bestell-Bezeichnung	Stok Stock Lager	Takım Ölçüleri (mm) Dimension (mm) Abmessung (mm)					Kesici Uç Insert Wendeschneidplatte	Yedek Parçaları / Spare Parts / Ersatzteile		
		DC	ZEFP	DCON	LF	APMX		Sıkma Vidası Screw Schraube	Tork Anahtar Torx Key Torx-Schlüssel	Montaj Vidası Mounting Screw Befestigungsschraube
AHFM-SP0945-D050-A22-Z06-H	●	50	6	22	40	1.4	SPMX 0945..	4115-M4x8	80-T15	2508-M10x30
AHFM-SP0945-D052-A22-Z06-H	●	52	6	22	40	1.4				

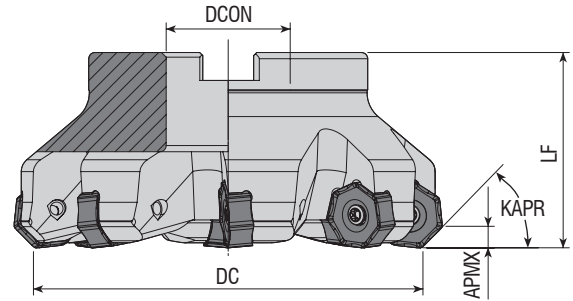
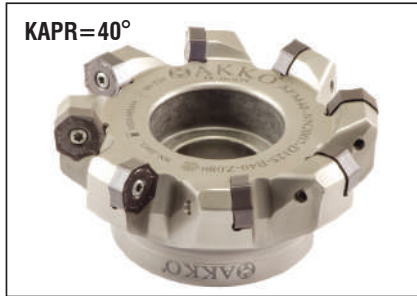

Takım Kodu Ordering Code Bestell-Bezeichnung	Stok Stock Lager	Takım Ölçüleri (mm) Dimension (mm) Abmessung (mm)					Kesici Uç Insert Wendeschneidplatte	Yedek Parçaları / Spare Parts / Ersatzteile		
		DC	ZEFP	DCON	LF	APMX		Sıkma Vidası Screw Schraube	Tork Anahtar Torx Key Torx-Schlüssel	Montaj Vidası Mounting Screw Befestigungsschraube
AFM40-NN2007-D080-A27-Z06-H	●	80	6	27	50	6	NNMU 2007..	1020-M5x14	80-T20	2514-M16x35
AFM40-NN2007-D100-B32-Z07-H	●	100	7	32	50	6				
AFM40-NN2007-D125-B40-Z08-H	●	125	8	40	63	6				
AFM40-NN2007-D160-C40-Z10	●	160	10	40	63	6				
AFM40-NN2007-D200-C60-Z12	●	200	12	60	63	6				

R: Sağ / Right / Rechts/ L: Sol / Left / Links

● Stokta / In Stock / Auf Lager ○ Stokta Yok / Non Stock Item / Kein Lagerartikel, Lieferzeit auf Anfrage

MTSBH Ucuna Uygunudur. / Compatible with MTSBH Insert. / Kompatibel mit MTSBH Wendeplatten.

Sipariş Örneği/Ordering Example/Bestellbeispiel

1 ad./pcs./stück AHFM-SP0945-D050-A22-Z06-H

Kesme Hesabı : S 429 / Cutting Calculation : P 429 / Schnittberechnung : P 429

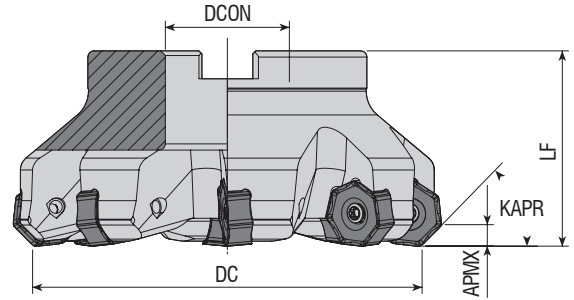

Takım Kodu Ordering Code Bestell-Bezeichnung	Stok Stock Lager	Takım Ölçüleri (mm) Dimension (mm) Abmessung (mm)					Kesici Uç Insert Wendeschneidplatte	Yedek Parçaları / Spare Parts / Ersatzteile			
		DC	ZEFP	DCON	LF	APMX		Sıkma Vidası Screw Schraube	Tork Anahtar Torx Key Torx-Schlüssel	Montaj Vidası Mounting Screw Befestigungsschraube	
AFM45-NN2007-D063-A22-Z05-H	●	63	5	22	50	6	NNMU 2007..	1020-M5x14	80-T20	2508-M10x30	
AFM45-NN2007-D080-A27-Z06-H	●	80	6	27	50	6				2510-M12x35	
AFM45-NN2007-D100-A32-Z07-H	●	100	7	32	50	6				2514-M16x35	
AFM45-NN2007-D125-B40-Z08	●	125	8	40	63	6					
AFM45-NN2007-D160-C40-Z10	●	160	10	40	63	6					

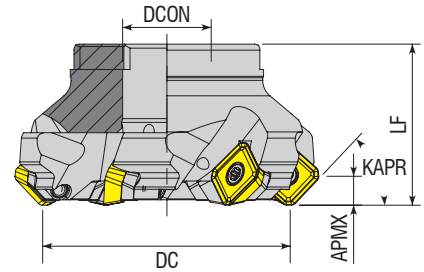
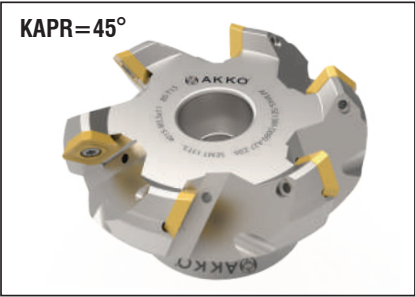

Takım Kodu Ordering Code Bestell-Bezeichnung	Stok Stock Lager	Takım Ölçüleri (mm) Dimension (mm) Abmessung (mm)					Kesici Uç Insert Wendeschneidplatte	Yedek Parçaları / Spare Parts / Ersatzteile			
		DC	ZEFP	DCON	LF	APMX		Sıkma Vidası Screw Schraube	Tork Anahtar Torx Key Torx-Schlüssel	Montaj Vidası Mounting Screw Befestigungsschraube	
AFM45-SE13M-D050-A22-Z04-H	●	50	4	22	40	6	SEMT 13T3..	4015-M3.5x11	80-T15	2508-M10x30	
AFM45-SE13M-D063-A22-Z05-H	●	63	5	22	40	6				2510-M12x35	
AFM45-SE13M-D080-A27-Z06	●	80	6	27	50	6				2514-M16x35	
AFM45-SE13M-D100-A32-Z07	●	100	7	32	50	6					
AFM45-SE13M-D125-B40-Z08	●	125	8	40	63	6					

R: Sağ / Right / Rechts L: Sol / Left / Links

● Stokta / In Stock / Auf Lager ○ Stokta Yok / Non Stock Item / Kein Lagerartikel, Lieferzeit auf Anfrage

MTSBH Ucuna Uygundur. / Compatible with MTSBH Insert. / Kompatibel mit MTSBH Wendeplatten.

Sipariş Örneği/Ordering Example/Bestellbeispiel

1 ad./pcs./stück AFM45-NN2007-D063-A22-Z05-H

Kesme Hesabı : S 429 / Cutting Calculation : P 429 / Schnittberechnung : P 429

Montaj Ölçüleri : S 426 / Mounting Reference : P 426 / Montagehinweis : P426

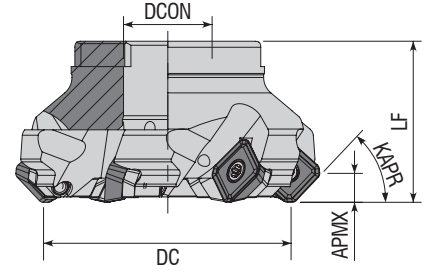

Takım Kodu Ordering Code Bestell-Bezeichnung	Stok Stock Lager	Takım Ölçüleri (mm) Dimension (mm) Abmessung (mm)					Kesici Uç Insert Wendeschneidplatte	Yedek Parçaları / Spare Parts / Ersatzteile				
		DC	ZEFP	DCON	LF	APMX		Altlık Screw Unterlage	Altlık Vidası Wedge Clamp Винт опорной пластины	Sıkma Vidası Screw Schraube	Tork Anahtar Torx Key Torx-Schlüssel	Montaj Vidası Mounting Screw Befestigungsschraube
AFM45S-SE13M-D050-A22-Z04-H	●	50	4	22	40	6	SE.13T3	AASE-3-0001	AAV-16-M3.5x8	4015-M3.5x12	80-T15	2508-M10x30
AFM45S-SE13M-D063-A22-Z05-H	●	63	5	22	40	6						
AFM45S-SE13M-D080-A27-Z06	●	80	6	27	50	6						
AFM45S-SE13M-D100-A32-Z07	●	100	7	32	50	6						
AFM45S-SE13M-D125-B40-Z08	●	125	8	40	63	6						

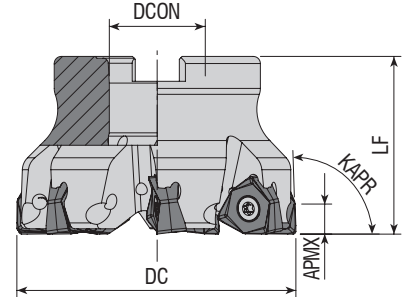

Takım Kodu Ordering Code Bestell-Bezeichnung	Stok Stock Lager	Takım Ölçüleri (mm) Dimension (mm) Abmessung (mm)					Kesici Uç Insert Wendeschneidplatte	Yedek Parçaları / Spare Parts / Ersatzteile			
		DC	ZEFP	DCON	LF	APMX		Sıkma Vidası Screw Schraube	Tork Anahtar Torx Key Torx-Schlüssel	Montaj Vidası Mounting Screw Befestigungsschraube	
AFM90-6N09-D050-A22-Z05-H	○	50	5	22	40	9	6NGU 0905..	1115-M4x10	80-T15	2508-M10x30	
AFM90-6N09-D063-A22-Z06-H	●	63	6	22	40	9					
AFM90-6N09-D080-A27-Z07-H	○	80	7	27	50	9					
AFM90-6N09-D100-A32-Z08-H	●	100	8	32	50	9	6NMU 1409..	1120-M5x12	80-T20	2514-M16x35	
AFM90-6N14-D050-A22-Z04-H	○	50	4	22	50	8.2					
AFM90-6N14-D063-A22-Z05-H	○	63	5	22	40	8.2					
AFM90-6N14-D080-A27-Z07-H	○	80	7	27	50	8.2					
AFM90-6N14-D100-A32-Z07-H	○	100	7	32	50	8.2					
AFM90-6N14-D125-B40-Z08	○	125	8	40	63	8.2					

R: Sağ / Right / Rechts L: Sol / Left / Links

● Stokta / In Stock / Auf Lager ○ Stokta Yok / Non Stock Item / Kein Lagerartikel, Lieferzeit auf Anfrage

MTSBH Ucuna Uygundur. / Compatible with MTSBH Insert. / Kompatibel mit MTSBH Wendeplatten.

Sipariş Örneği/Ordering Example/Bestellbeispiel

1 ad./pcs./stück AFM45S-SE13M-D050-A22-Z04-H

Kesme Hesabı : S 429 / Cutting Calculation : P 429 / Schnittberechnung : P 429

Montaj Ölçüleri : S 426 / Mounting Reference : P 426 / Montagehinweis : P426

MTSBH Ucuna Uygun. / Compatible with MTSBH Insert. / Kompatibel mit MTSBH Wendeplatten.

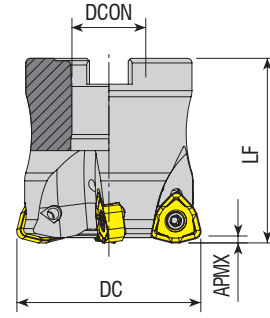

Takım Kodu Ordering Code Bestell-Bezeichnung	Stok Stock Lager	Takım Ölçüleri (mm) Dimension (mm) Abmessung (mm)					Kesici Uç Insert Wendeschneidplatte	Yedek Parçaları / Spare Parts / Ersatzteile		
		DC	ZEFP	DCON	LF	APMX		Sıkma Vidası Screw Schraube	Tork Anahtar Torx Key Torx-Schlüssel	Montaj Vidası Mounting Screw Befestigungsschraube
AHFM-J009-D050-A22-Z04-H	●	50	4	22	50	1.2	JOMU 0905..	1110-M3x8.5	82-T10	2508-M10x30
AHFM-J009-D063-A22-Z05-H	●	63	5	22	50	1.2				

MTSBH Ucuna Uygun. / Compatible with MTSBH Insert. / Kompatibel mit MTSBH Wendeplatten.

NTK Ucuna Uygun. / Compatible with NTK Insert. / Kompatibel mit NTK Wendeplatten.

KAPR=88°

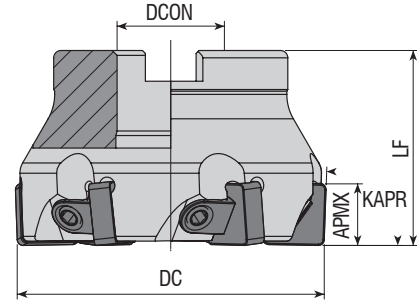

Takım Kodu Ordering Code Bestell-Bezeichnung	Stok Stock Lager	Takım Ölçüleri (mm) Dimension (mm) Abmessung (mm)					Kesici Uç Insert Wendeschneidplatte	Yedek Parçaları / Spare Parts / Ersatzteile			
		DC	ZEFP	DCON	LF	APMX		Baskı Parçası Wedge Clamp Spannpratze	Baskı Vidası Clamp Screw Klemmschraube	Anahtar Allen Key Innensechskantschlüssel	Montaj Vidası Mounting Screw Befestigungsschraube
AFM88C-SN1204-D050-A22-Z05	●	50	5	22	40	11	SN.. 1204..	ACK-21	AKV-24-M6x1x18	AAL-03-3	2408-M10x30
AFM88C-SN1204-D063-A22-Z06	●	63	6	22	40	11					2510-M12x35
AFM88C-SN1204-D080-A27-Z07	●	80	7	27	50	11					2514-M16x35
AFM88C-SN1204-D100-A32-Z08	●	100	8	32	50	11					-
AFM88C-SN1204-D125-B40-Z11	●	125	11	40	63	11					-

R: Sağ / Right / Rechts L: Sol / Left / Links

● Stokta / In Stock / Auf Lager ○ Stokta Yok / Non Stock Item / Kein Lagerartikel, Lieferzeit auf Anfrage

NTK Ucuna Uygun. / Compatible with NTK Insert. / Kompatibel mit NTK Wendeplatten.

Sipariş Örneği/Ordering Example/Bestellbeispiel

1 ad./pcs./stück AHFM-J009-D050-A22-Z04-H

Kesme Hesabı : S 429 / Cutting Calculation : P 429 / Schnittberechnung : P 429

Sıkma Tork Değeri : S 428 / Tightening Torque : P 428 / Anzugsmoment : P 428

PLBT Ucuna Uyundur. / Compatible with PLBT Insert. / Kompatibel mit PLBT Wendeplatten.

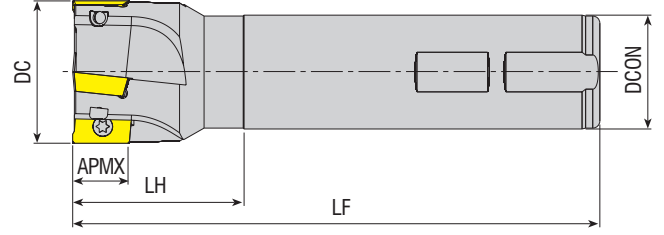

Takım Kodu Ordering Code Bestell-Bezeichnung	Stok Stock Lager	Takım Ölçüleri (mm) Dimension (mm) Abmessung (mm)						Kesici Uç Insert Wendeschneidplatte	Yedek Parçaları / Spare Parts / Ersatzteile		
		DC	ZEFP	DCON	LF	LH	APMX		Sıkma Vidası Screw Schraube	Tork Anahtar Torx Key Torx-Schlüssel	
AEM90-AP16P-D25-W25-L100-Z02-H	●	25	2	25	100	35	16	AP. 1604..			
AEM90-AP16P-D25-W25-L150-Z02	●	25	2	25	150	50	16				
AEM90-AP16P-D32-W32-L150-Z03	●	32	3	32	150	50	16				
AEM90-AP16P-D32-C32-L250-Z02	●	32	2	32	250	100	16				
AEM90-AP16P-D40-W32-L150-Z04	●	40	4	32	150	50	16				

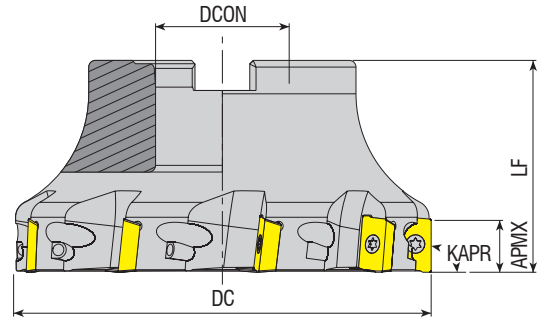

Takım Kodu Ordering Code Bestell-Bezeichnung	Stok Stock Lager	Takım Ölçüleri (mm) Dimension (mm) Abmessung (mm)					Kesici Uç Insert Wendeschneidplatte	Yedek Parçaları / Spare Parts / Ersatzteile			
		DC	ZEFP	DCON	LF	APMX		Sıkma Vidası Screw Schraube	Tork Anahtar Torx Key Torx-Schlüssel	Montaj Vidası Mounting Screw Befestigungsschraube	
AFM90-AP16P-D040-A16-Z04-H	●	40	4	16	40	16	AP. 1604..			2506-M8x30	
AFM90-AP16P-D050-A22-Z05-H	●	50	5	22	40	16				2508-M10x30	
AFM90-AP16P-D063-A22-Z06-H	●	63	6	22	40	16				2510-M12x35	
AFM90-AP16P-D080-A27-Z07-H	●	80	7	27	50	16				2514-M16x35	
AFM90-AP16P-D100-A32-Z08-H	●	100	8	32	50	16					

R: Sağ / Right / Rechts/ L: Sol / Left / Links

● Stokta / In Stock / Auf Lager ○ Stokta Yok / Non Stock Item / Kein Lagerartikel, Lieferzeit auf Anfrage

PLBT Ucuna Uyundur. / Compatible with PLBT Insert. / Kompatibel mit PLBT Wendeplatten.

Sipariş Örneği/Ordering Example/Bestellbeispiel

1 ad./pcs./stück AEM90-AP16P-D25-W25-L100-Z02-H

Kesme Hesabı : S 429 / Cutting Calculation : P 429 / Schnittberechnung : P 429

Sıkma Tork Değeri : S 428 / Tightening Torque : P 428 / Anzugsmoment : P 428

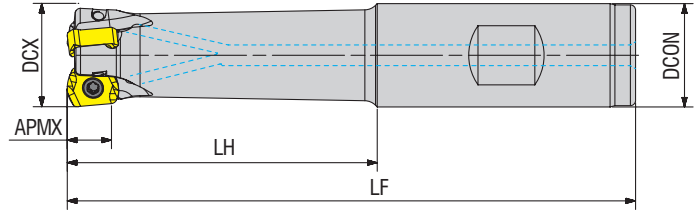

Takım Kodu Ordering Code Bestell-Bezeichnung	Stok Stock Lager	Takım Ölçüleri (mm) Dimension (mm) Abmessung (mm)						Kesici Uç Insert Wendeschneidplatte	Yedek Parçaları / Spare Parts / Ersatzteile				
		DCX	ZEPF	DCON	LF	LH	APMX		Sıkma Vidası Screw Schraube	Baskı Parçası Wedge Clamp Spannpratze	Baskı Vidası Clamp Screw Schraube	Tork Anahtar Torx Key Torx-Schlüssel	
AHFM-XN06T3-D20-W20-L110-Z03-H	●	20	3	20	110	60	1.25						
AHFM-XN06T3-D20-W20-L80-Z03-H	●	20	3	20	80	30	1.25						82-T08

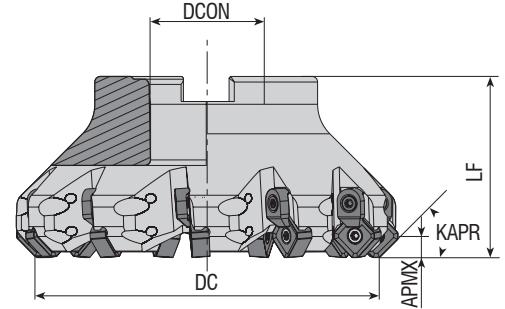

Takım Kodu Ordering Code Bestell-Bezeichnung	Stok Stock Lager	Takım Ölçüleri (mm) Dimension (mm) Abmessung (mm)					Kesici Uç Insert Wendeschneidplatte	Yedek Parçaları / Spare Parts / Ersatzteile				
		DC	ZEPF	DCON	LF	APMX		Sıkma Vidası Screw Schraube	Baskı Parçası Wedge Clamp Spannpratze	Baskı Vidası Clamp Screw Klemmschraube	Tork Anahtar Torx Key Torx-Schlüssel	Montaj Vidası Mounting Screw Befestigungsschraube
AFM45C-SN1206-D050-A22-Z04-H	●	50	4	22	42	6						
AFM45CL-SN1206-D050-A22-Z05-H	●	50	5	22	42	6						
AFM45C-SN1206-D050-A22-Z05-H	●	50	5	22	42	6						
AFM45C-SN1206-D063-A22-Z06-H	●	63	6	22	42	6						
AFM45C-SN1206-D063-A22-Z07-H	●	63	7	22	42	6						
AFM45CL-SN1206-D063-A22-Z07-H	●	63	7	22	42	6						
AFM45C-SN1206-D080-A27-Z07-H	●	80	7	27	52	6						
AFM45C-SN1206-D080-A27-Z08-H	●	80	8	27	52	6						
AFM45CL-SN1206-D080-A27-Z08-H	●	80	8	27	52	6						
AFM45C-SN1206-D100-A32-Z08-H	●	100	8	32	52	6						
AFM45C-SN1206-D100-A32-Z10-H	●	100	10	32	52	6						
AFM45CL-SN1206-D100-A32-Z10-H	●	100	10	32	52	6						
AFM45C-SN1206-D125-B40-Z11	●	125	11	40	65	6						
AFM45CL-SN1206-D125-B40-Z11	●	125	11	40	65	6						
AFM45C-SN1206-D160-C40-Z12	●	160	12	40	65	6						
AFM45CL-SN1206-D160-C40-Z12	●	160	12	40	65	6						
AFM45C-SN1206-D200-C60-Z14	●	200	14	60	65	6						
AFM45CL-SN1206-D200-C60-Z14	●	200	14	60	65	6						

R: Sağ / Right / Rechts! L: Sol / Left / Links

● Stokta / In Stock / Auf Lager ○ Stokta Yok / Non Stock Item / Kein Lagerartikel, Lieferzeit auf Anfrage

PLBT Ucuna Uygun. / Compatible with PLBT Insert. / Kompatibel mit PLBT Wendeplatten.

Sipariş Örneği/Ordering Example/Bestellbeispiel

1 ad./pcs./stück AHFM-XN06T3-D20-W20-L110-Z03-H

Kesme Hesabı : S 429 / Cutting Calculation : P 429 / Schnittberechnung : P 429

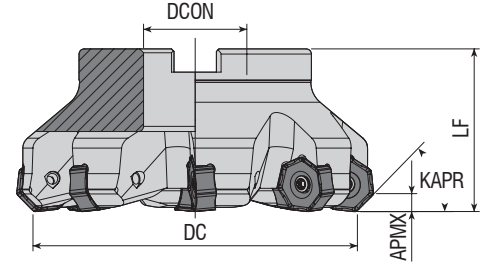

Takım Kodu
Ordering Code
Bestell-Bezeichnung

Stok
Stock
Lager

Takım Ölçüleri (mm)
Dimension (mm)
Abmessung (mm)

Kesici Uç
Insert
Wendeschneidplatte

Sıkma Vidası
Screw
Schraube

Tork Anahtar
Torx Key
Torx-Schlüssel

Montaj Vidası
Mounting Screw
Befestigungsschraube

Yedek Parçaları / Spare Parts / Ersatzteile

	Stok	DC	ZEFP	DCON	LF	APMX				
• new • AFM44-ON0606-D063-A22-Z05-H	●	63	5	22	40	3.8	ONHX 0606..	4020-M4.5x12	80-T20	2407-M10x30
AFM44-ON0606-D063-A22-Z06-H	●	63	6	22	40	3.8				2510-M12x35
AFM44-ON0606-D080-A27-Z08-H	●	80	8	27	50	3.8				-
• new • AFM44-ON0606-D080-B27-Z06-H	●	80	6	27	50	3.8				2514-M16x35
AFM44-ON0606-D100-A32-Z10-H	●	100	10	32	50	3.8				-
• new • AFM44-ON0606-D100-B32-Z07-H	●	100	7	32	50	3.8				-
• new • AFM44-ON0606-D125-B40-Z08-H	●	125	8	40	63	3.8				

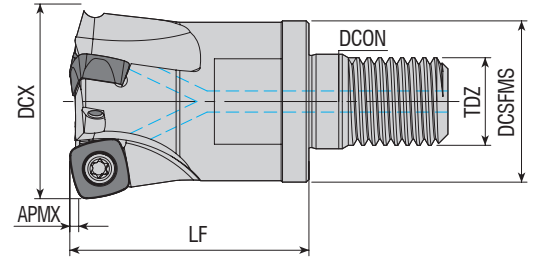

Takım Kodu
Ordering Code
Bestell-Bezeichnung

Stok
Stock
Lager

Takım Ölçüleri (mm)
Dimension (mm)
Abmessung (mm)

Kesici Uç
Insert
Wendeschneidplatte

Sıkma Vidası
Screw
Schraube

Tork Anahtar
Torx Key
Torx-Schlüssel

Yedek Parçaları / Spare Parts / Ersatzteile

	Stok	DCX	ZEFP	DC SFMS	TDZ	LF	DCON	APMX			
AHFM-S00803P-D32-M16-L35-Z04-H	●	32	4	29	M16	35	17	1	SOEW 0803	4010-M3x8	82-T10
AHFM-S00803P-D42-M16-L35-Z05-H	●	42	5	29	M16	35	17	1			

R: Sağ / Right / Rechts L: Sol / Left / Links

● Stokta / In Stock / Auf Lager ○ Stokta Yok / Non Stock Item / Kein Lagerartikel, Lieferzeit auf Anfrage

PLBT Ucuna Uygundur. / Compatible with PLBT Insert. / Kompatibel mit PLBT Wendeplatten.

Sipariş Örneği/Ordering Example/Bestellbeispiel

1 ad./pcs./stück AFM44-ON0606-D063-A22-Z05-H

Kesme Hesabı : S 429 / Cutting Calculation : P 429 / Schnittberechnung : P 429

Montaj Ölçüleri : S 426 / Mounting Reference : P 426 / Montagehinweis : P 426

PLBT Ucuna Uygundur. / Compatible with PLBT Insert. / Kompatibel mit PLBT Wendeplatten.

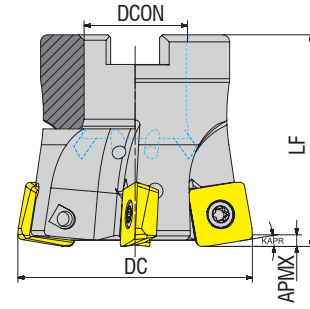

Takım Kodu Ordering Code Bestell-Bezeichnung	Stok Stock Lager	Takım Ölçüleri (mm) Dimension (mm) Abmessung (mm)					Kesici Uç Insert Wendeschneidplatte	Yedek Parçaları / Spare Parts / Ersatzteile		
		DCX	ZEPF	DCON	LF	APMX		Sıkma Vidası Screw Schraube	Tork Anahtar Torx Key Torx-Schlüssel	Montaj Vidası Mounting Screw Befestigungsschraube
AHFM-SP13-D050-A22-Z04-H	●	50	4	22	45	1.5	SP. 1305..	4015-M4x11	80-T15	2508-M10X30
AHFM-SP13-D063-A27-Z05-H	●	63	5	27	50	1.5				2510-M12x35

PLBT Ucuna Uygundur. / Compatible with PLBT Insert. / Kompatibel mit PLBT Wendeplatten.

PRMT Ucuna Uygundur. / Compatible with PRMT Insert. / Kompatibel mit PRMT Wendeplatten.

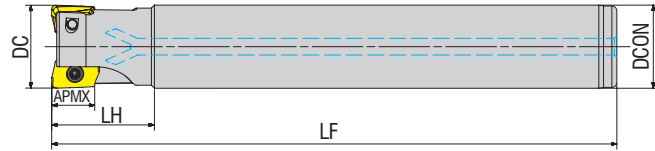

Takım Kodu Ordering Code Bestell-Bezeichnung	Stok Stock Lager	Takım Ölçüleri (mm) Dimension (mm) Abmessung (mm)						Kesici Uç Insert Wendeschneidplatte	Yedek Parçaları / Spare Parts / Ersatzteile	
		DCX	ZEPF	DCON	LF	LH	APMX		Sıkma Vidası Screw Schraube	Tork Anahtar Torx Key Torx-Schlüssel
AEM90-AD06-D10-C10-L100-Z02-H	○	10	2	10	100	15	5	AD.. 0602..	3006-M2x3.6	82-T06
AEM90-AD06-D12-C12-L120-Z02-H	○	12	2	12	120	15	5			
AEM90-AD06-D16-C16-L160-Z03-H	○	16	3	16	160	20	5			
AEM90-AD10PR-D16-C15-L170-Z02-H	○	16	2	15	170	25	10	AD.. 1003..	3008-M2.5x6	82-T08
AEM90-AD10PR-D16-C16-L170-Z02-H	○	16	2	16	170	25	10			
AEM90-AD10PR-D20-C19-L170-Z03-H	○	20	3	19	170	25	10			
AEM90-AD10PR-D20-C20-L170-Z03-H	○	20	3	20	170	30	10			
AEM90-AD10PR-D25-C25-L200-Z03-H	○	25	3	25	200	30	10			
AEM90-AD13-D20-C20-L150-Z02-H	○	20	2	20	150	30	12	AD.. 1304..	3010-M3.5x7	82-T10
AEM90-AD13-D25-C25-L170-Z02-H	○	25	2	25	170	30	12			

R: Sağ / Right / Rechts/ L: Sol / Left / Links

● Stokta / In Stock / Auf Lager ○ Stokta Yok / Non Stock Item / Kein Lagerartikel, Lieferzeit auf Anfrage

PRMT Ucuna Uygundur. / Compatible with PRMT Insert. / Kompatibel mit PRMT Wendeplatten.

Sipariş Örneği/Ordering Example/Bestellbeispiel

1 ad./pcs./stück AHFM-SP13-D050-A22-Z04-H

Kesme Hesabı : S 429 / Cutting Calculation : P 429 / Schnittberechnung : P 429

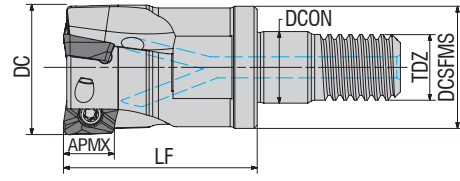
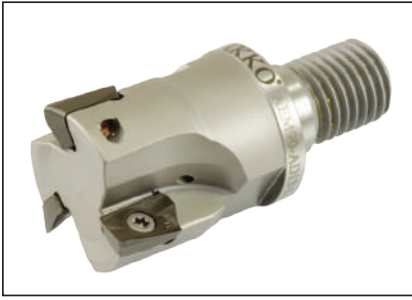

Takım Kodu
Ordering Code
Bestell-Bezeichnung

Takım Kodu Ordering Code Bestell-Bezeichnung	Stok Stock Lager	Takım Ölçüleri (mm) Dimension (mm) Abmessung (mm)						Kesici Uç Insert Wendeschneidplatte	Yedek Parçaları / Spare Parts / Ersatzteile				
		DC	ZEFP	DCON	LF	LH	APMX		Sıkma Vidası Screw Schraube	Baskı Parçası Wedge Clamp Spannpratze	Baskı Vidası Clamp Screw Schraube	Tork Anahtar Torx Key Torx-Schlüssel	
AEM90-AD06-D12-M06-L20-Z02-H	○	12	2	6.5	20	-	5	AD.. 0602..	3006-M2x3.6	3006-M2x3.6			82-T06
AEM90-AD06-D16-M08-L23-Z03-H	○	16	3	8.5	23	-	5						
AEM90-AD10PR-D16-M08-L23-Z02-H	○	16	2	8.5	23	-	10	AD.. 1003..	3008-M2.5x5	3008-M2.5x6			82-T08
AEM90-AD10PR-D20-M10-L30-Z03-H	○	20	3	10.5	30	-	10						
AEM90-AD10PR-D25-M12-L35-Z04-H	○	25	4	12.5	35	-	10						
AEM90-AD10PR-D32-M16-L40-Z04-H	○	32	4	17	40	-	10						
AEM90-AD10PR-D35-M16-L45-Z05-H	○	35	5	17	45	-	10						
AEM90-AD13-D20-M10-L30-Z02-H	○	20	2	10.5	30	-	12	AD.. 1304..	3010-M3.5x7	3010-M3.5x7			82-T10
AEM90-AD13-D25-M12-L35-Z03-H	○	25	3	12.5	35	-	12						
AEM90-AD13-D32-M16-L40-Z03-H	○	32	3	17	40	-	12						
AEM90-AD13-D35-M16-L45-Z04-H	○	35	4	17	45	-	12						

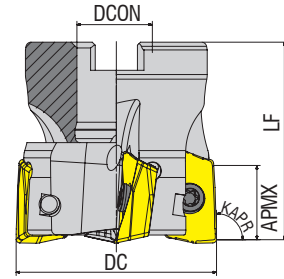

Takım Kodu
Ordering Code
Bestell-Bezeichnung

Takım Kodu Ordering Code Bestell-Bezeichnung	Stok Stock Lager	Takım Ölçüleri (mm) Dimension (mm) Abmessung (mm)					Kesici Uç Insert Wendeschneidplatte	Yedek Parçaları / Spare Parts / Ersatzteile		
		DC	ZEFP	DCON	LF	APMX		Sıkma Vidası Screw Schraube	Tork Anahtar Torx Key Torx-Schlüssel	Montaj Vidası Mounting Screw Befestigungsschraube
AFM90-AD13-D040-A16-Z04-H	●	40	4	16	40	12	AD.. 1304..	3010-M3.5x7	82-T10	2506-M8x30
AFM90-AD13-D050-A22-Z05-H	●	50	5	22	40	12				2508-M10x30
AFM90-AD13-D063-A22-Z06-H	●	63	6	22	40	12				2510-M12x35
AFM90-AD16PR-D080-A27-Z07-H	●	80	7	27	50	13	AD.. 1606..	4015-M4x11	80-T15	2406-M8x30
AFM90-AD17-D040-A16-Z04-H	●	40	4	16	40	16	AD.. 1706..	4015-M4x9		2508-M10x30
AFM90-AD17-D050-A22-Z05-H	●	50	5	22	40	16			2510-M12x35	
AFM90-AD17-D063-A22-Z05-H	●	63	5	22	40	16			2514-M16x35	
AFM90-AD17-D080-A27-Z06-H	●	80	6	27	50	16				
AFM90-AD17-D100-A32-Z07-H	●	100	7	32	50	16				



KAPR=90°

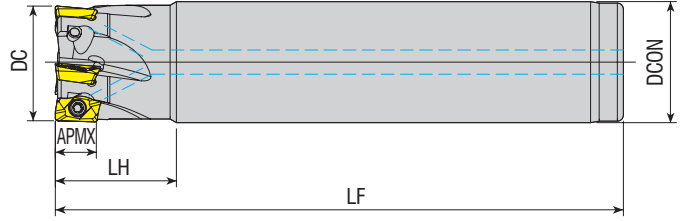

Takım Kodu
Ordering Code
Bestell-Bezeichnung

Stok
Stock
Lager

Takım Ölçüleri (mm)
Dimension (mm)
Abmessung (mm)

Kesici Uç
Insert
Wendeschneidplatte

Yedek Parçaları / Spare Parts / Ersatzteile

Sıkma Vidası
Screw
Schraube

Tork Anahtar
Torx Key
Torx-Schlüssel

Takım Kodu Ordering Code Bestell-Bezeichnung	Stok Stock Lager	DC	ZEPF	DCON	LF	LH	APMX	Kesici Uç Insert Wendeschneidplatte	Sıkma Vidası Screw Schraube	Tork Anahtar Torx Key Torx-Schlüssel
AEM90-AD07-D10-C08-L90-Z02-H	●	10	2	8	90	16	6	ADMX 0702..	3006-M2x3.3 3006-M2x3.1 3006-M2x3.3 3006-M2x3.6 3006-M2x4	82-T06
AEM90-AD07-D10-C10-L80-Z02-H	●	10	2	10	80	16	6			
AEM90-AD07-D12-C10-L80-Z03-H	●	12	3	10	80	18	6			
AEM90-AD07-D12-C12-L90-Z03-H	●	12	3	12	90	18	6			
AEM90-AD07-D16-C16-L110-Z04-H	●	16	4	16	110	19	6			
AEM90-AD07-D20-C20-L125-Z05-H	●	20	5	20	125	20	6			
AEM90-AD07-D25-C25-L140-Z06-H	●	25	6	25	140	24	6	ADMX 11T3..	3008-M2.5x5 3008-M2.5x6	82-T08
AEM90-AD11-D16-C16-L135-Z02-H	●	16	2	16	135	24	9			
AEM90-AD11-D18-C16-L135-Z02-H	●	18	2	16	135	15	9			
AEM90-AD11-D18-C16-L160-Z02-H	●	18	2	16	160	15	9			
AEM90-AD11-D20-C20-L150-Z02-H	●	20	2	20	150	50	9			
AEM90-AD11-D20-C20-L150-Z03-H	●	20	3	20	150	50	9			
AEM90-AD11-D22-C20-L150-Z03-H	●	22	3	20	150	15	9			
AEM90-AD11-D22-C20-L200-Z03-H	●	22	3	20	200	15	9			
AEM90-AD11-D25-C25-L170-Z03-H	●	25	3	25	170	50	9			
AEM90-AD11-D25-C25-L170-Z04-H	●	25	4	25	170	50	9			
AEM90-AD11-D28-C25-L165-Z04-H	●	28	4	25	165	17	9			
AEM90-AD11-D28-C25-L200-Z04-H	●	28	4	25	200	17	9			
AEM90-AD11-D30-C25-L165-Z04-H	●	30	4	25	165	19	9			
AEM90-AD11-D30-C25-L200-Z04-H	●	30	4	25	200	19	9			
AEM90-AD11-D32-C32-L195-Z05-H	●	32	5	32	195	50	9			

R: Sağ / Right / Rechts/ L: Sol / Left / Links

● Stokta / In Stock / Auf Lager ○ Stokta Yok / Non Stock Item / Kein Lagerartikel, Lieferzeit auf Anfrage

PRMT Ucuna Uygundur. / Compatible with PRMT Insert. / Kompatibel mit PRMT Wendeplatten.

Sipariş Örneği/Ordering Example/Bestellbeispiel
1 ad./pcs./stück AEM90-AD07-D10-C08-L90-Z02-H

Kesme Hesabı : S 429 / Cutting Calculation : P 429 / Schnittberechnung : P 429

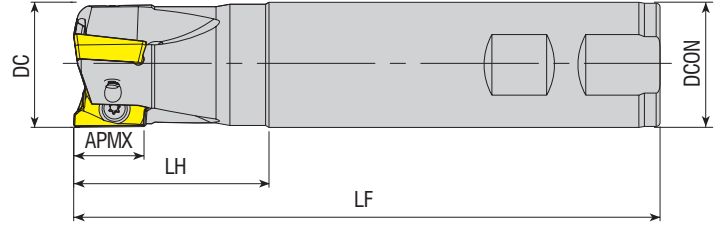

Takım Kodu
Ordering Code
Bestell-Bezeichnung

Stok
Stock
Lager

Takım Ölçüleri (mm)
Dimension (mm)
Abmessung (mm)

Kesici Uç
Insert
Wendeschneidplatte

Yedek Parçaları / Spare Parts / Ersatzteile

Sıkma Vidası
Screw
Schraube

Tork Anahtar
Torx Key
Torx-Schlüssel

Takım Kodu Ordering Code Bestell-Bezeichnung	Stok Stock Lager	DC	ZEFP	DCON	LF	LH	APMX	Kesici Uç Insert Wendeschneidplatte	Sıkma Vidası Screw Schraube	Tork Anahtar Torx Key Torx-Schlüssel
AEM90-RT07-D10-W10-L120-Z02	●	10	2	10	120	30	7	RT 0702	3006-M2x4	82-T06
AEM90-RT07-D12-C12-L120-Z02	●	12	2	12	120	30	7			
AEM90-RT07-D12-W12-L120-Z02	●	12	2	12	120	30	7			
AEM90-RT07-D14-W12-L120-Z02	●	14	2	12	120	30	7			
AEM90-RT10-D16-C15-L160-Z02	●	16	2	15	160	30	10	RT 1003	3008-M2.5x6	82-T08
AEM90-RT10-D16-W16-L120-Z02-H	●	16	2	16	120	30	10			
AEM90-RT10-D16-W16-L150-Z02	●	16	2	16	150	30	10			
AEM90-RT10-D16-C16-L200-Z02	●	16	2	16	200	100	10			
AEM90-RT10-D17-W16-L160-Z02	●	17	2	16	160	30	10			
AEM90-RT10-D17-C16-L200-Z02	●	17	2	16	200	30	10			
AEM90-RT10-D18-W16-L120-Z02-H	●	18	2	16	120	30	10			
AEM90-RT10-D20-C19-L200-Z03	●	20	3	19	200	30	10			
AEM90-RT10-D20-C20-L110-Z03	●	20	3	20	110	30	10			
AEM90-RT10-D20-W20-L120-Z03-H	●	20	3	20	120	30	10			
AEM90-RT10-D20-W20-L150-Z03	●	20	3	20	150	50	10			
AEM90-RT10-D20-C20-L200-Z03	●	20	3	20	200	100	10			
AEM90-RT10-D21-W20-L200-Z03	●	21	3	20	200	30	10			
AEM90-RT10-D22-W20-L120-Z03-H	●	22	3	20	120	30	10			
AEM90-RT10-D22-C20-L150-Z03	●	22	3	20	150	30	10			
AEM90-RT10-D22-C20-L200-Z03	●	22	3	20	200	30	10			
AEM90-RT10-D25-W25-L120-Z04-H	●	25	4	25	120	40	10			
AEM90-RT10-D25-W25-L150-Z04	●	25	4	25	150	50	10			
AEM90-RT10-D25-C25-L200-Z04	●	25	4	25	200	100	10			
AEM90-RT10-D26-C25-L250-Z04	●	26	4	25	250	32	10			
AEM90-RT10-D32-W32-L120-Z05-H	●	32	5	32	120	50	10			
AEM90-RT10-D32-W32-L150-Z05	●	32	5	32	150	50	10			
AEM90-RT10-D32-C32-L200-Z05	●	32	5	32	200	100	10			
AEM90-RT10-D33-C32-L250-Z04	●	33	4	32	250	32	10			
AEM90-RT13-D32-C32-L250-Z04	●	32	4	32	250	50	13	RT 1304	3008-M3x8	
AEM90-RT16-D25-W25-L120-Z02-H	●	25	2	25	120	40	16	RT 1606	4015-M4x9	80-T15
AEM90-RT16-D25-W25-L150-Z02	●	25	2	25	150	50	16			
AEM90-RT16-D25-C25-L200-Z02	●	25	2	25	200	100	16			
AEM90-RT16-D32-W32-L120-Z03-H	●	32	3	32	120	50	16			
AEM90-RT16-D32-W32-L150-Z03	●	32	3	32	150	50	16			
AEM90-RT16-D32-C32-L200-Z03	●	32	3	32	200	100	16			
AEM90-RT16-D32-C32-L250-Z03	●	32	3	32	250	100	16			
AEM90-RT16-D32-C32-L270-Z03	●	32	3	32	270	100	16			
AEM90-RT16-D40-W32-L120-Z04-H	●	40	4	32	120	50	16			
AEM90-RT16-D40-W32-L150-Z04	●	40	4	32	150	50	16			
AEM90-RT16-D40-C32-L200-Z04	●	40	4	32	200	100	16			

R: Sağ / Right / Rechts/ L: Sol / Left / Links

● Stokta / In Stock / Auf Lager ○ Stokta Yok / Non Stock Item / Kein Lagerartikel, Lieferzeit auf Anfrage

PRMT Ucuna Uygundur. / Compatible with PRMT Insert. / Kompatibel mit PRMT Wendeplatten.

Sipariş Örneği/Ordering Example/Bestellbeispiel

1 ad./pcs./stück AEM90-RT07-D10-W10-L120-Z02

Kesme Hesabı : S 429 / Cutting Calculation : P 429 / Schnittberechnung : P 429

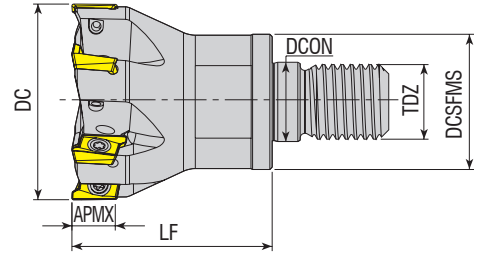

Takım Kodu Ordering Code Bestell-Bezeichnung	Stok Stock Lager	Takım Ölçüleri (mm) Dimension (mm) Abmessung (mm)							Kesici Uç Insert Wendeschneidplatte	Yedek Parçaları / Spare Parts / Ersatzteile		
		DC	ZEFP	DCSFMS	TDZ	LF	DCON	APMX		Sıkma Vidası Screw Schraube	Tork Anahtar Torx Key Torx-Schlüssel	
new AEM90-RT07-D13-M06-L20-Z02-H	●	13	2	11	M06	20	6.5	7	RT 0702..	3006-M2x4	82-T06	
AEM90-RT10-D16-M08-L20-Z02-H	●	16	2	14.75	M08	20	8.5	10				
new AEM90-RT10-D17-M08-L20-Z02-H	●	17	2	14.75	M08	20	8.5	7	RT 1003..	3008-M2.5x6	82-T08	
AEM90-RT10-D20-M10-L25-Z03-H	●	20	3	18	M10	25	10.5	10				
new AEM90-RT10-D21-M10-L25-Z03-H	●	21	3	18	M10	25	10.5	10				
new AEM90-RT10-D26-M12-L35-Z03-H	●	26	3	21	M12	35	12.5	10				
new AEM90-RT10-D26-M12-L35-Z04-H	●	26	4	21	M12	35	12.5	10				
AEM90-RT10-D25-M12-L30-Z04-H	●	25	4	21	M12	30	12.5	10				
AEM90-RT10-D32-M16-L43-Z05-H	●	32	5	29	M16	43	17	10				
AEM90-RT10-D42-M16-L43-Z06-H	●	42	6	29	M16	43	17	10				

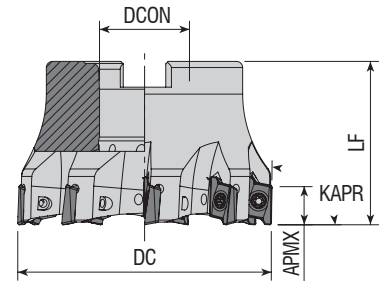

Takım Kodu Ordering Code Bestell-Bezeichnung	Stok Stock Lager	Takım Ölçüleri (mm) Dimension (mm) Abmessung (mm)					Kesici Uç Insert Wendeschneidplatte	Yedek Parçaları / Spare Parts / Ersatzteile			
		DC	ZEFP	DCON	LF	APMX		Sıkma Vidası Screw Schraube	Tork Anahtar Torx Key Torx-Schlüssel	Montaj Vidası Mounting Screw Befestigungsschraube	
AFM90-RT10-D040-A16-Z06-H	●	40	6	16	40	10	RT 1003	3008-M2.5x6	82-T08	2506-M8x30	
AFM90-RT10-D050-A22-Z07-H	●	50	7	22	40	10				2407-M10x30	
AFM90-RT10-D063-A22-Z09-H	●	63	9	22	40	10					
AFM90-RT16-D040-A16-Z04-H	●	40	4	16	40	16	RT 1606	4015-M4x11	80-T15	2506-M8x30	
AFM90-RT16-D063-A22-Z06-H	●	63	6	22	40	16				2508-M10x30	
AFM90-RT16-D080-A27-Z07-H	●	80	7	27	50	16				2510-M12x35	
AFM90-RT16-D125-B40-Z09	●	125	9	40	63	16				-	

R: Sağ / Right / Rechts L: Sol / Left / Links

● Stokta / In Stock / Auf Lager ○ Stokta Yok / Non Stock Item / Kein Lagerartikel, Lieferzeit auf Anfrage

PRMT Ucuna Uygun. / Compatible with PRMT Insert. / Kompatibel mit PRMT Wendeplatten.

Sipariş Örneği/Ordering Example/Bestellbeispiel

1 ad./pcs./stück AEM90-RT07-D13-M06-L20-Z02-H

Kesme Hesabı : S 429 / Cutting Calculation : P 429 / Schnittberechnung : P 429

Montaj Ölçüleri : S 426 / Mounting Reference : P 426 / Montagehinweis : P426

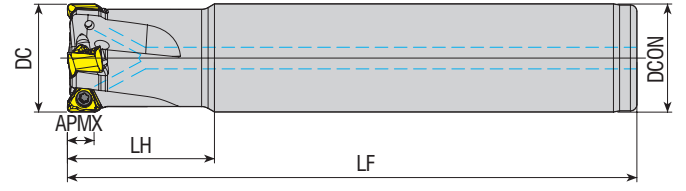

Takım Kodu Ordering Code Bestell-Bezeichnung	Stok Stock Lager	Takım Ölçüleri (mm) Dimension (mm) Abmessung (mm)						Kesici Uç Insert Wendeschneidplatte	Yedek Parçaları / Spare Parts / Ersatzteile		
		DC	ZEFP	DCON	LF	LH	APMX		Sıkma Vidası Screw Schraube	Tork Anahtar Torx Key Torx-Schlüssel	
AEM90-TNG10-D20-W20-L90-Z02-H	●	20	2	20	90	32	5	TNGX 1004..	3008-M2.5x6	82-T08	
AEM90-TNG10-D20-W20-L90-Z03-H	●	20	3	20	90	32	5				
AEM90-TNG10-D20-C20-L125-Z02-H	●	20	2	20	125	29	5				
AEM90-TNG10-D20-C20-L125-Z03-H	●	20	3	20	125	29	5				
AEM90-TNG10-D20-C20-L150-Z03-H	●	20	3	20	150	50	5				
AEM90-TNG10-D21-C20-L200-Z03-H	●	21	3	20	200	30	5				
AEM90-TNG10-D25-C25-L150-Z03-H	●	25	3	25	100	42	5				
AEM90-TNG10-D25-W25-L100-Z03-H	●	25	4	25	100	42	5				
AEM90-TNG10-D25-W25-L100-Z04-H	●	25	3	25	150	34	5				
AEM90-TNG10-D25-C25-L150-Z04-H	●	25	4	25	150	34	5				
AEM90-TNG10-D25-C25-L170-Z04-H	●	25	4	25	170	50	5				
AEM90-TNG10-D26-C25-L250-Z04-H	●	26	4	25	250	35	5				
AEM90-TNG10-D28-W25-L100-Z04-H	●	28	4	25	100	29	5				
AEM90-TNG10-D32-W32-L110-Z04-H	●	32	4	32	110	42	5				
AEM90-TNG10-D32-W32-L110-Z05-H	●	32	5	32	110	42	5				
AEM90-TNG10-D32-C32-L170-Z04-H	●	32	4	32	170	37	5				
AEM90-TNG10-D32-C32-L170-Z05-H	●	32	5	32	170	37	5				
AEM90-TNG10-D33-C32-L250-Z05-H	●	33	5	32	250	35	5				
AEM90-TNG16-D25-C25-L170-Z02-H	●	25	2	25	170	34	10	TNGX 1606..	3015-M4x11	80-T15	
AEM90-TNG16-D25-C25-L170-Z02-H-80	●	25	2	25	170	80	10				
AEM90-TNG16-D25-W25-L110-Z02-H	●	25	2	25	110	42	10				
new AEM90-TNG16-D32-C25-L195-Z02-H	●	32	2	25	195	34	10				
new AEM90-TNG16-D32-C25-L195-Z03-H	●	32	3	25	195	34	10				
AEM90-TNG16-D32-C32-L195-Z02-H	●	32	2	32	195	34	10				
AEM90-TNG16-D32-C32-L195-Z02-H-80	●	32	2	32	195	80	10				
AEM90-TNG16-D32-C32-L195-Z03-H	●	32	3	32	195	34	10				
AEM90-TNG16-D32-W32-L110-Z03-H	●	32	3	32	110	42	10				
AEM90-TNG16-D35-C32-L195-Z04-H	●	35	4	32	195	34	10				
AEM90-TNG16-D40-W32-L120-Z04-H	●	40	4	32	120	50	10				

R: Sağ / Right / Rechts L: Sol / Left / Links

● Stokta / In Stock / Auf Lager ○ Stokta Yok / Non Stock Item / Kein Lagerartikel, Lieferzeit auf Anfrage

PRMT Ucuna Uygundur. / Compatible with PRMT Insert. / Kompatibel mit PRMT Wendeplatten.

Sipariş Örneği/Ordering Example/Bestellbeispiel

1 ad./pcs./stück AEM90-TNG10-D20-W20-L90-Z02-H

Kesme Hesabı : S 429 / Cutting Calculation : P 429 / Schnittberechnung : P 429

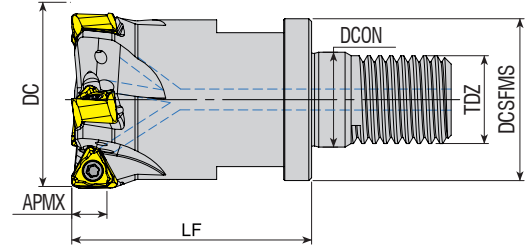

Takım Kodu
Ordering Code
Bestell-Bezeichnung

Stok
Stock
Lager

Takım Ölçüleri (mm)
Dimension (mm)
Abmessung (mm)

Kesici Uç
Insert
Wendeschneidplatte

Yedek Parçaları / Spare Parts / Ersatzteile

Sıkma Vidası
Screw
Schraube

Tork Anahtar
Torx Key
Torx-Schlüssel

Takım Kodu Ordering Code Bestell-Bezeichnung	Stok Stock Lager	Takım Ölçüleri (mm) Dimension (mm) Abmessung (mm)							Kesici Uç Insert Wendeschneidplatte	Yedek Parçaları / Spare Parts / Ersatzteile	
		DC	ZEFP	DCSFMS	TDZ	LF	DCON	APMX		Sıkma Vidası Screw Schraube	Tork Anahtar Torx Key Torx-Schlüssel
AEM90-TNG10-D20-M10-L26-Z02-H	●	20	2	18	M10	26	10.5	5	TNGX 1004..	3008-M2.5x6	82-T08
AEM90-TNG10-D20-M10-L26-Z03-H	●	20	3	18	M10	26	10.5	5			
AEM90-TNG10-D21-M10-L25-Z03-H	●	21	3	18	M10	25	10.5	5			
AEM90-TNG10-D25-M12-L33-Z03-H	●	25	3	21	M12	33	12.5	5			
AEM90-TNG10-D25-M12-L33-Z04-H	●	25	4	21	M12	33	12.5	5			
AEM90-TNG10-D26-M12-L30-Z04-H	●	26	4	21	M12	30	12.5	5			
AEM90-TNG10-D32-M16-L43-Z04-H	●	32	4	29	M16	43	17	5			
AEM90-TNG10-D32-M16-L43-Z05-H	●	32	5	29	M16	43	17	5			
AEM90-TNG10-D33-M16-L43-Z05-H	●	33	5	29	M16	43	17	5			
AEM90-TNG10-D35-M16-L43-Z05-H	●	35	5	29	M16	43	17	5			

R: Sağ / Right / Rechts/ L: Sol / Left / Links

● Stokta / In Stock / Auf Lager ○ Stokta Yok / Non Stock Item / Kein Lagerartikel, Lieferzeit auf Anfrage

PRMT Ucuna Uygundur. / Compatible with PRMT Insert. / Kompatibel mit PRMT Wendeplatten.

Sipariş Örneği/Ordering Example/Bestellbeispiel

1 ad./pcs./stück AEM90-TNG10-D20-M10-L26-Z02-H

Kesme Hesabı : S 429 / Cutting Calculation : P 429 / Schnittberechnung : P 429

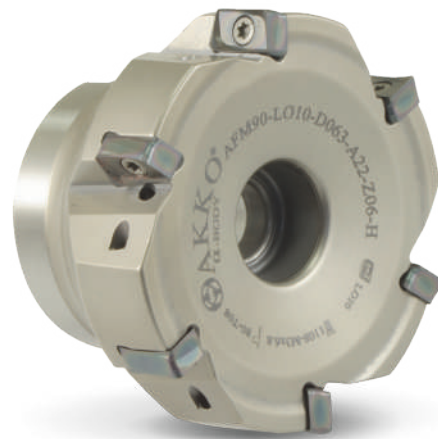
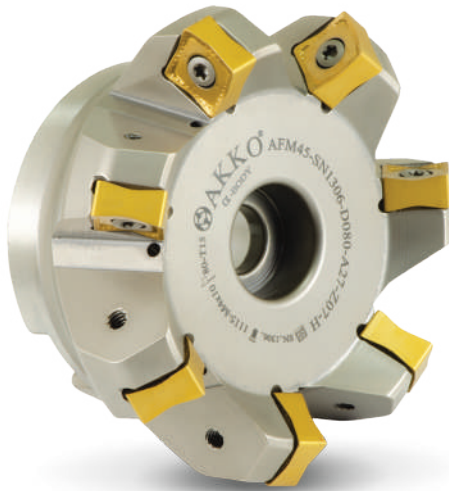



KAPR=90°

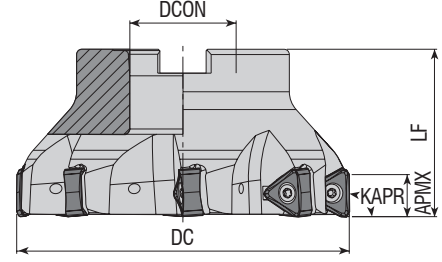

Takım Kodu
Ordering Code
Bestell-Bezeichnung

Stok
Stock
Lager

Takım Ölçüleri (mm)
Dimension (mm)
Abmessung (mm)

Kesici Uç
Insert
Wendeschneidplatte

Sıkma Vidası
Screw
Schraube

Tork Anahtar
Torx Key
Torx-Schlüssel

Montaj Vidası
Mounting Screw
Befestigungsschraube

Yedek Parçaları / Spare Parts / Ersatzteile

Takım Kodu Ordering Code Bestell-Bezeichnung	Stok Stock Lager	DC	ZEFP	DCON	LF	APMX	Kesici Uç Insert Wendeschneidplatte	Sıkma Vidası Screw Schraube	Tork Anahtar Torx Key Torx-Schlüssel	Montaj Vidası Mounting Screw Befestigungsschraube
AFM90-TNG10-D040-A16-Z04-H	●	40	4	16	40	5	TNGX 1004..	3008-M2.5x6	82-T08	2506-M8x30
AFM90-TNG10-D040-A16-Z06-H	○	40	6	16	40	5				2508-M10x30
AFM90-TNG10-D050-A22-Z05-H	○	50	5	22	40	5				2508-M10x30
AFM90-TNG10-D050-A22-Z07-H	○	50	7	22	40	5				2508-M10x30
AFM90-TNG10-D063-A22-Z06-H	○	63	6	22	40	5				2510-M12x35
AFM90-TNG10-D063-A22-Z09-H	○	63	9	22	40	5				2510-M12x35
AFM90-TNG10-D080-A27-Z10-H	○	80	10	27	50	5	TNGX 1606..	3015-M4x11	80-T15	2508-M10x30
AFM90-TNG16-D040-A16-Z03-H	○	40	3	16	40	10				2510-M12x35
AFM90-TNG16-D040-A16-Z04-H	○	40	4	16	40	10				2510-M12x35
AFM90-TNG16-D050-A22-Z04-H	○	50	4	22	40	10				2510-M12x35
AFM90-TNG16-D050-A22-Z05-H	○	50	5	22	40	10				2514-M16x35
AFM90-TNG16-D063-A22-Z04-H	○	63	4	22	40	10				2514-M16x35
AFM90-TNG16-D063-A22-Z06-H	○	63	6	22	40	10				2514-M16x35
AFM90-TNG16-D080-A27-Z05-H	○	80	5	27	50	10				2514-M16x35
AFM90-TNG16-D080-A27-Z07-H	●	80	7	27	50	10				2514-M16x35
AFM90-TNG16-D100-A32-Z06-H	○	100	6	32	50	10				2514-M16x35
AFM90-TNG16-D100-A32-Z08-H	○	100	8	32	50	10				2514-M16x35
AFM90-TNG16-D115-A32-Z06-H	○	115	6	32	50	10				2514-M16x35
AFM90-TNG16-D125-A40-Z07-H	○	125	7	40	63	10				2514-M16x35
AFM90-TNG16-D125-A40-Z09-H	○	125	9	40	63	10				2514-M16x35
AFM90-TNG16-D140-B40-Z08-H	○	140	8	40	63	10	2514-M16x35			
AFM90-TNG16-D160-C40-Z10-H	○	160	10	40	63	10	2514-M16x35			
AFM90-TNG16-D175-C40-Z10-H	○	175	10	40	63	10	2514-M16x35			

R: Sağ / Right / Rechts L: Sol / Left / Links

● Stokta / In Stock / Auf Lager ○ Stokta Yok / Non Stock Item / Kein Lagerartikel, Lieferzeit auf Anfrage

PRMT Ucuna Uygunudur. / Compatible with PRMT Insert. / Kompatibel mit PRMT Wendeplatten.

Sipariş Örneği/Ordering Example/Bestellbeispiel

1 ad./pcs./stück AFM90-TNG10-D040-A16-Z04-H

Kesme Hesabı : S 429 / Cutting Calculation : P 429 / Schnittberechnung : P 429

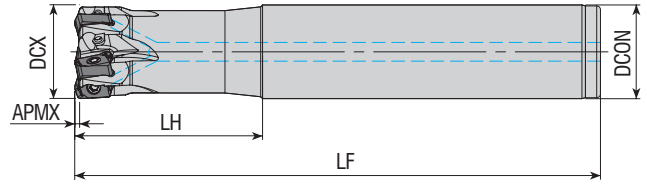

Takım Kodu
Ordering Code
Bestell-Bezeichnung

Stok
Stock
Lager

Takım Ölçüleri (mm)
Dimension (mm)
Abmessung (mm)

Kesici Uç
Insert
Wendeschneidplatte

Yedek Parçaları / Spare Parts / Ersatzteile

Tork Anahtar
Torx Key
Torx-Schlüssel

Takım Kodu Ordering Code Bestell-Bezeichnung	Stok Stock Lager	DCX	ZEFP	DCON	LF	LH	APMX	Kesici Uç Insert Wendeschneidplatte	Sıkma Vidası Screw Schraube	Tork Anahtar Torx Key Torx-Schlüssel
AHFM-BN10T3-D16-C16-L100-Z02-H	●	16	2	16	100	30	1	BNGX 10T3..	3008-M2.5x6	82-T08
AHFM-BN10T3-D16-C16-L150-Z02-H	●	16	2	16	150	50	1			
AHFM-BN10T3-D20-C20-L130-Z03-H	●	20	3	20	130	40	1			
AHFM-BN10T3-D20-C20-L130-Z04-H	●	20	4	20	130	40	1			
AHFM-BN10T3-D20-C20-L160-Z03-H	●	20	3	20	160	80	1			
AHFM-BN10T3-D25-C25-L140-Z04-H	●	25	4	25	140	50	1			
AHFM-BN10T3-D25-W25-L140-Z04-H	●	25	4	25	140	50	1			
AHFM-BN10T3-D25-C25-L140-Z05-H	●	25	5	25	140	50	1			
AHFM-BN10T3-D25-C25-L180-Z04-H	●	25	4	25	180	100	1			
AHFM-BN10T3-D32-C32-L150-Z05-H	●	32	5	32	150	70	1			
AHFM-BN10T3-D32-C32-L150-Z06-H	●	32	6	32	150	70	1			
AHFM-BN10T3-D35-C32-L200-Z06-H	●	35	6	32	200	50	1			

new

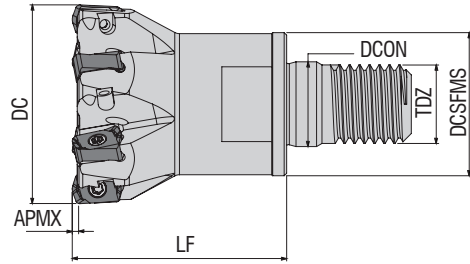

Takım Kodu
Ordering Code
Bestell-Bezeichnung

Stok
Stock
Lager

Takım Ölçüleri (mm)
Dimension (mm)
Abmessung (mm)

Kesici Uç
Insert
Wendeschneidplatte

Yedek Parçaları / Spare Parts / Ersatzteile

Sıkma Vidası
Screw
Schraube

Tork Anahtar
Torx Key
Torx-Schlüssel

Takım Kodu Ordering Code Bestell-Bezeichnung	Stok Stock Lager	DCX	ZEFP	DCSFMS	TDZ	LF	DCON	APMX	Kesici Uç Insert Wendeschneidplatte	Sıkma Vidası Screw Schraube	Tork Anahtar Torx Key Torx-Schlüssel
AHFM-BN10T3-D16-M08-L25-Z02-H	●	16	2	14.75	M08	25	8.5	1	BNGX 10T3..	3008-M2.5x6	82-T08
AHFM-BN10T3-D20-M10-L30-Z04-H	●	20	4	18	M10	30	10.5	1			
AHFM-BN10T3-D25-M12-L33-Z05-H	●	25	5	20.7	M12	33	12.5	1			
AHFM-BN10T3-D32-M16-L40-Z06-H	●	32	6	28.7	M16	40	17	1			
AHFM-BN10T3-D40-M16-L43-Z06-H	●	40	6	28.7	M16	43	17	1			

R: Sağ / Right / Rechts/ L: Sol / Left / Links

● Stokta / In Stock / Auf Lager ○ Stokta Yok / Non Stock Item / Kein Lagerartikel, Lieferzeit auf Anfrage

PRMT Ucuna Uygun. / Compatible with PRMT Insert. / Kompatibel mit PRMT Wendeplatten.

Sipariş Örneği/Ordering Example/Bestellbeispiel
1 ad./pcs./stück AHFM-BN10T3-D16-C16-L100-Z02-H
Kesme Hesabı : S 429 / Cutting Calculation : P 429 / Schnittberechnung : P 429

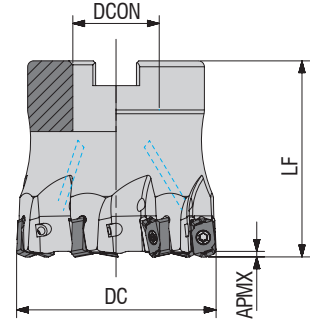

Takım Kodu Ordering Code Bestell-Bezeichnung	Stok Stock Lager	Takım Ölçüleri (mm) Dimension (mm) Abmessung (mm)					Kesici Uç Insert Wendeschneidplatte	Yedek Parçaları / Spare Parts / Ersatzteile			
		DCX	ZEFP	DCON	LF	APMX		Sıkma Vidası Screw Schraube	Tork Anahtar Torx Key Torx-Schlüssel	Montaj Vidası Mounting Screw Befestigungsschraube	
AHFM-BN10T3-D040-A16-Z05-H	●	40	5	16	40	1	BNGX 10T3..	3008-M2.5x6	82-T08	2506-M8x30	
AHFM-BN10T3-D042-A16-Z05-H	●	42	5	16	40	1					
AHFM-BN10T3-D050-A22-Z07-H	●	50	7	22	50	1					
AHFM-BN10T3-D052-A22-Z07-H	●	52	7	22	50	1					

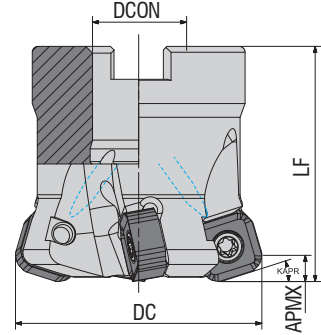

Takım Kodu Ordering Code Bestell-Bezeichnung	Stok Stock Lager	Takım Ölçüleri (mm) Dimension (mm) Abmessung (mm)					Kesici Uç Insert Wendeschneidplatte	Yedek Parçaları / Spare Parts / Ersatzteile			
		DCX	ZEFP	DCON	LF	APMX		Sıkma Vidası Screw Schraube	Tork Anahtar Torx Key Torx-Schlüssel	Montaj Vidası Mounting Screw Befestigungsschraube	
AHFM-SN1104-D042-A16-Z04-H	●	42	4	16	40	1.7	SN.. 1104..	1715-M4x14	80-T15	2406-M8x30	
AHFM-SN1104-D050-A22-Z05-H	●	50	5	22	40	1.7					
AHFM-SN1104-D050-A22-Z06-H	●	50	6	22	40	1.7					
AHFM-SN1104-D052-A22-Z05-H	●	52	5	22	40	1.7					
AHFM-SN1104-D052-A22-Z06-H	●	52	6	22	40	1.7					
AHFM-SN1104-D063-A22-Z06-H	●	63	6	22	40	1.7					
AHFM-SN1104-D066-A27-Z06-H	●	66	6	27	50	1.7					
AHFM-SN1104-D080-A27-Z07-H	●	80	7	27	50	1.7					
AHFM-SN1104-D080-A27-Z09-H	●	80	9	27	50	1.7					
AHFM-SN1104-D100-A32-Z08-H	●	100	8	32	50	1.7					
AHFM-SN1104-D125-B40-Z08-H	●	125	8	40	63	1.7					
										2510-M12x35	
										2514-M16x35	
										-	

R: Sağ / Right / Rechts/ L: Sol / Left / Links

● Stokta / In Stock / Auf Lager ○ Stokta Yok / Non Stock Item / Kein Lagerartikel, Lieferzeit auf Anfrage

PRMT Ucuna Uygundur. / Compatible with PRMT Insert. / Kompatibel mit PRMT Wendeplatten.

Sipariş Örneği/Ordering Example/Bestellbeispiel

1 ad./pcs./stück AHFM-BN10T3-D040-A16-Z05-H

Kesme Hesabı : S 429 / Cutting Calculation : P 429 / Schnittberechnung : P 429

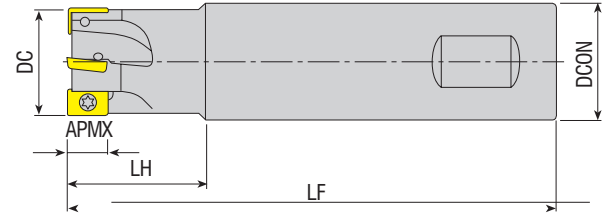

Takım Kodu Ordering Code Bestell-Bezeichnung	Stok Stock Lager	Takım Ölçüleri (mm) Dimension (mm) Abmessung (mm)						Yedek Parçaları / Spare Parts / Ersatzteile		
		DC	ZEFP	DCON	LF	LH	APMX	Sıkma Vidası Screw Schraube	Tork Anahtar Torx Key Torx-Schlüssel	
AEM90-XC13-D20-W20-L150-Z02	●	20	2	20	150	60	13	XCKX 13T3..	3008-M3x6	82-T08
AEM90-XC13-D25-W25-L150-Z03	●	25	3	25	150	60	13		3008-M3x8	
AEM90-XC13-D32-W32-L150-Z04	●	32	4	32	150	60	13			

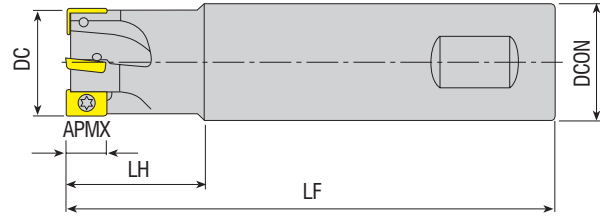

Takım Kodu Ordering Code Bestell-Bezeichnung	Stok Stock Lager	Takım Ölçüleri (mm) Dimension (mm) Abmessung (mm)						Kesici Uç Insert Wendeschneidplatte	Yedek Parçaları / Spare Parts / Ersatzteile	
		DC	ZEFP	DCON	LF	LH	APMX		Sıkma Vidası Screw Schraube	Tork Anahtar Torx Key Torx-Schlüssel
new AEM90-X006-D10-C10-L100-Z02-H	●	10	2	10	100	15	5	XO.. 0602..	3006-M1.8x4	82-T06
AEM90-X006-D10-C12-L120-Z02	●	10	2	12	120	50	5			
AEM90-X006-D12-C12-L120-Z02	●	12	2	12	120	25	5			
new AEM90-X006-D12-C12-L120-Z02-H	●	12	2	12	120	15	5	XO.. 0903..	3008-M2.5x5	82-T08
AEM90-X009-D16-W16-L150-Z02	●	16	2	16	150	50	8			
AEM90-X009-D20-W20-L150-Z03	●	20	3	20	150	50	8			
new AEM90-X009-D16-C16-L170-Z02-H	●	16	2	16	170	50	8	XO.. 10T3..	3008-M2.5x6	82-T08
new AEM90-X009-D20-C20-L170-Z03-H	●	20	3	20	170	30	8			
new AEM90-X010-D20-C19-L170-Z03-H	●	20	3	19	170	30	9			
new AEM90-X010-D20-C20-L170-Z03-H	●	20	3	20	170	50	9	XO.. 1204..	3010-M3.5x7	82-T10
AEM90-X012-D20-W20-L150-Z02	●	20	2	20	150	50	11			
AEM90-X012-D20-C20-L200-Z02	●	20	2	20	200	100	11			
AEM90-X012-D22-W20-L150-Z02	●	22	2	20	150	30	11	XO.. 1204..	3010-M3.5x7	82-T10
AEM90-X012-D25-W25-L150-Z03	●	25	3	25	150	50	11			
new AEM90-X012-D25-C25-L170-Z03-H	●	25	3	25	170	100	11			
AEM90-X012-D25-C25-L200-Z03	●	25	3	25	200	100	11	XO.. 1204..	3010-M3.5x7	82-T10
AEM90-X012-D32-C25-L150-Z04	●	32	4	25	150	40	11			
AEM90-X012-D32-W32-L150-Z04	●	32	4	32	150	50	11			
AEM90-X012-D32-C32-L250-Z04	●	32	4	32	250	100	11			

R: Sağ / Right / Rechts/ L: Sol / Left / Links

● Stokta / In Stock / Auf Lager ○ Stokta Yok / Non Stock Item / Kein Lagerartikel, Lieferzeit auf Anfrage

SC Ucuna Uygundur. / Compatible with SC Insert. / Kompatibel mit SC Wendeplatten.

Sipariş Örneği/Ordering Example/Bestellbeispiel
1 ad./pcs./stück AEM90-XC13-D20-W20-L150-Z02
Kesme Hesabı : S 429 / Cutting Calculation : P 429 / Schnittberechnung : P 429

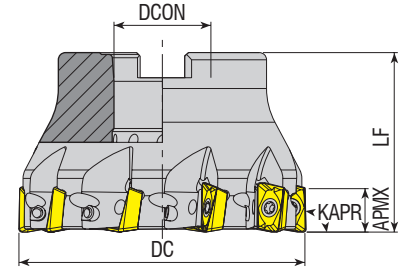

Takım Kodu Ordering Code Bestell-Bezeichnung	Stok Stock Lager	Takım Ölçüleri (mm) Dimension (mm) Abmessung (mm)					Kesici Uç Insert Wendeschneidplatte	Yedek Parçaları / Spare Parts / Ersatzteile		
		DC	ZEPF	DCON	LF	APMX		Sıkma Vidası Screw Schraube	Tork Anahtar Torx Key Torx-Schlüssel	Montaj Vidası Mounting Screw Befestigungsschraube
AFM90-XO12-D040-A16-Z05-H	●	40	5	16	40	11	XO.. 1204..	3010-M3.5x9	82-T10	2506-M8x30
AFM90-XO12-D050-A22-Z07-H	●	50	7	22	40	11				2508-M10x30
AFM90-XO12-D063-A22-Z08-H	●	63	8	22	40	11				2510-M12x35
AFM90-XO12-D080-A27-Z10-H	●	80	10	27	50	11				2514-M16x35
AFM90-XO12-D100-A32-Z12-H	●	100	12	32	50	11				

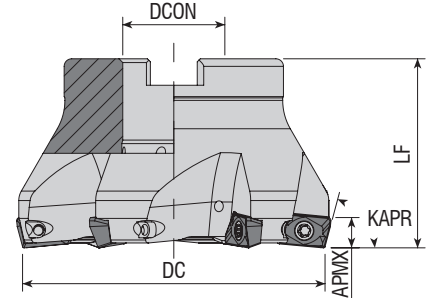

Takım Kodu Ordering Code Bestell-Bezeichnung	Stok Stock Lager	Takım Ölçüleri (mm) Dimension (mm) Abmessung (mm)					Kesici Uç Insert Wendeschneidplatte	Yedek Parçaları / Spare Parts / Ersatzteile		
		DC	ZEPF	DCON	LF	APMX		Sıkma Vidası Screw Schraube	Tork Anahtar Torx Key Torx-Schlüssel	Montaj Vidası Mounting Screw Befestigungsschraube
AFM75-XO12-D050-A22-Z04-H	●	50	4	22	40	-	XO.. 1204..	3010-M3.5x9	82-T10	2508-M10x30
AFM75-XO12-D063-A22-Z05-H	●	63	5	22	40	-				2510-M12x35
AFM75-XO12-D080-A27-Z06-H	●	80	6	27	50	-				

R: Sağ / Right / Rechts L: Sol / Left / Links

● Stokta / In Stock / Auf Lager ○ Stokta Yok / Non Stock Item / Kein Lagerartikel, Lieferzeit auf Anfrage

SC Ucuna Uygundur. / Compatible with SC Insert. / Kompatibel mit SC Wendeplatten.

Sipariş Örneği/Ordering Example/Bestellbeispiel

1 ad./pcs./stück AFM90-XO12-D040-A16-Z05-H

Kesme Hesabı : S 429 / Cutting Calculation : P 429 / Schnittberechnung : P 429

Montaj Ölçüleri : S 426 / Mounting Reference : P 426 / Montagehinweis : P426

SC Ucuna Uygundur. / Compatible with SC Insert. / Kompatibel mit SC Wendeplatten.

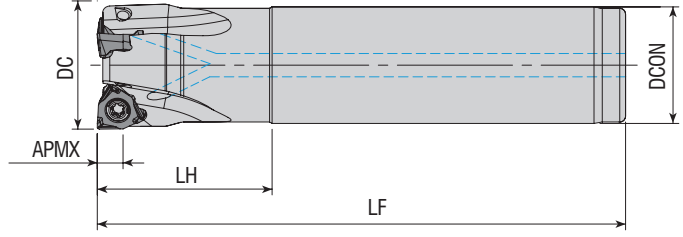

Takım Kodu Ordering Code Bestell-Bezeichnung	Stok Stock Lager	Takım Ölçüleri (mm) Dimension (mm) Abmessung (mm)						Kesici Uç Insert Wendeschneidplatte	Yedek Parçaları / Spare Parts / Ersatzteile		
		DC	ZEFP	DCON	LF	LH	APMX		Sıkma Vidası Screw Schraube	Tork Anahtar Torx Key Torx-Schlüssel	
AEM90-XN0403-D16-C16-L100-Z01-H	●	16	1	16	100	30	4				
AEM90-XN0403-D22-C20-L110-Z03-H	●	22	3	20	110	30	4				
AEM90-XN0806-D32-C32-L110-Z02-H	●	32	2	32	110	40	7.5				XNEX 0806..

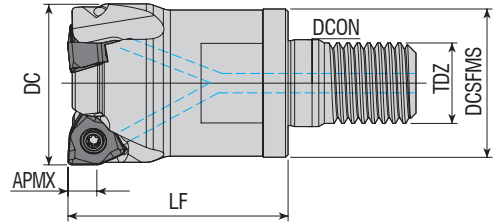

Takım Kodu Ordering Code Bestell-Bezeichnung	Stok Stock Lager	Takım Ölçüleri (mm) Dimension (mm) Abmessung (mm)							Kesici Uç Insert Wendeschneidplatte	Yedek Parçaları / Spare Parts / Ersatzteile		
		DC	ZEFP	DCSFMS	TDZ	LF	DCON	APMX		Sıkma Vidası Screw Schraube	Tork Anahtar Torx Key Torx-Schlüssel	
AEM90-XN0403-D32-M16-L43-Z05-H	●	32	5	29	M16	43	17	4				
AEM90-XN0403-D42-M16-L43-Z06-H	●	42	6	29	M16	43	17	4				

R: Sağ / Right / Rechts/ L: Sol / Left / Links
● Stokta / In Stock / Auf Lager ○ Stokta Yok / Non Stock Item / Kein Lagerartikel, Lieferzeit auf Anfrage
SC Ucuna Uygundur. / Compatible with SC Insert. / Kompatibel mit SC Wendeplatten.

Sipariş Örneği/Ordering Example/Bestellbeispiel
1 ad./pcs./stück AEM90-XN0403-D16-C16-L100-Z01-H
Kesme Hesabı : S 429 / Cutting Calculation : P 429 / Schnittberechnung : P 429

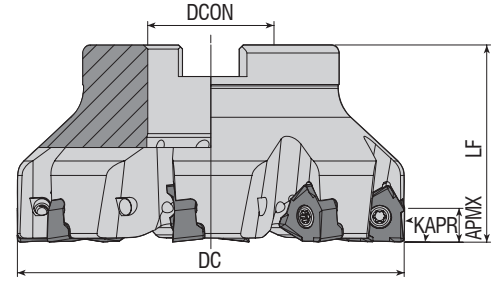

Takım Kodu Ordering Code Bestell-Bezeichnung	Stok Stock Lager	Takım Ölçüleri (mm) Dimension (mm) Abmessung (mm)					Kesici Uç Insert Wendeschneidplatte	Yedek Parçaları / Spare Parts / Ersatzteile					
		DC	ZEFP	DCON	LF	APMX		Sıkma Vidası Screw Schraube	Tork Anahtar Torx Key Torx-Schlüssel	Montaj Vidası Mounting Screw Befestigungsschraube			
AFM90-XN0403-D040-A16-Z05-H	●	40	5	16	40	4	XNEX 0403..	3008-M2.5x6	82-T08	2506-M8x30			
AFM90-XN0806-D050-A22-Z04-H	●	50	4	22	40	7.5				2508-M10x30			
new AFM90-XN0806-D050-A22-Z05-H	●	50	5	22	40	7.5				XNEX 0806..	4015-M4x11	80-T15	2408-M10x30
AFM90-XN0806-D063-A22-Z05-H	●	63	5	22	40	7.5							2508-M10x30
AFM90-XN0806-D080-A27-Z07-H	●	80	7	27	50	7.5							2510-M12x35
AFM90-XN0806-D100-A32-Z08-H	●	100	8	32	50	7.5							2514-M16x35

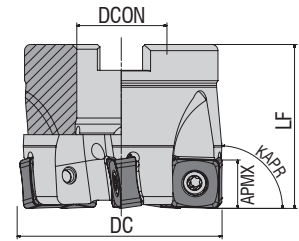

Takım Kodu Ordering Code Bestell-Bezeichnung	Stok Stock Lager	Takım Ölçüleri (mm) Dimension (mm) Abmessung (mm)					Kesici Uç Insert Wendeschneidplatte	Yedek Parçaları / Spare Parts / Ersatzteile		
		DC	ZEFP	DCON	LF	APMX		Sıkma Vidası Screw Schraube	Tork Anahtar Torx Key Torx-Schlüssel	Montaj Vidası Mounting Screw Befestigungsschraube
AFM88-SN12SC-D050-A22-Z05-H	●	50	5	22	40	9	SN.. 1204..	4015-M4x11	80-T15	2508-M10x30
AFM88-SN12SC-D063-A22-Z06-H	●	63	6	22	40	9				2510-M12x35
AFM88-SN12SC-D080-A27-Z07-H	●	80	7	27	50	9				2514-M16x35
AFM88-SN12SC-D100-A32-Z08-H	●	100	8	32	50	9				

R: Sağ / Right / Rechts L: Sol / Left / Links

● Stokta / In Stock / Auf Lager ○ Stokta Yok / Non Stock Item / Kein Lagerartikel, Lieferzeit auf Anfrage

SC Ucuna Uygundur. / Compatible with SC Insert. / Kompatibel mit SC Wendeplatten.

Sipariş Örneği/Ordering Example/Bestellbeispiel

1 ad./pcs./stück AFM90-XN0403-D040-A16-Z05-H

Kesme Hesabı : S 429 / Cutting Calculation : P 429 / Schnittberechnung : P 429

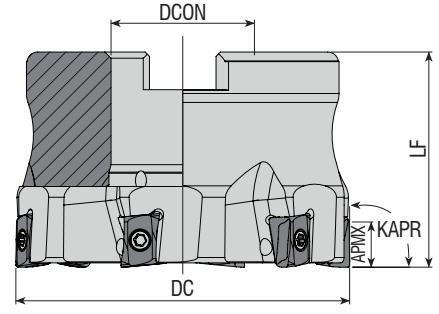

Takım Kodu
Ordering Code
Bestell-Bezeichnung

Stok
Stock
Lager

Takım Ölçüleri (mm)
Dimension (mm)
Abmessung (mm)

Kesici Uç
Insert
Wendeschneidplatte

Yedek Parçaları / Spare Parts / Ersatzteile

Sıkma Vidası
Screw
Schraube

Tork Anahtar
Torx Key
Torx-Schlüssel

Montaj Vidası
Mounting Screw
Befestigungsschraube

AFM90-L008-D040-A16-Z06-H
AFM90-L008-D050-A22-Z07-H
AFM90-L008-D063-A27-Z06-H

Stok	DC	ZEFP	DCON	LF	APMX
●	40	6	16	40	2
●	50	7	22	40	2
●	63	6	27	40	2



LOEX 0804..

3008-M2.5x8

82-T08

2506-M8x30
2508-M10x30
2510-M12x35

R: Sağ / Right / Rechts! L: Sol / Left / Links

● Stokta / In Stock / Auf Lager ○ Stokta Yok / Non Stock Item / Kein Lagerartikel, Lieferzeit auf Anfrage

SC Ucuna Uygun. / Compatible with SC Insert. / Kompatibel mit SC Wendeplatten.

Sipariş Örneği/Ordering Example/Bestellbeispiel

1 ad./pcs./stück AFM90-L008-D040-A16-Z06-H

Kesme Hesabı : S 429 / Cutting Calculation : P 429 / Schnittberechnung : P 429



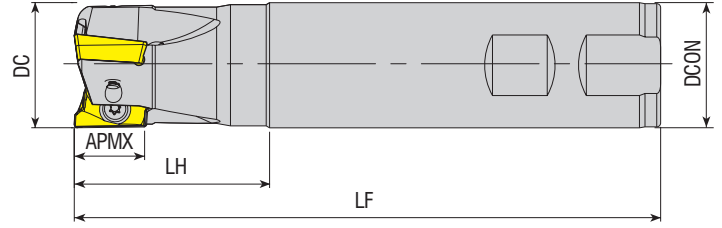

Takım Kodu
Ordering Code
Bestell-Bezeichnung

Stok
Stock
Lager

Takım Ölçüleri (mm)
Dimension (mm)
Abmessung (mm)

Kesici Uç
Insert
Wendeschneidplatte

Yedek Parçaları / Spare Parts / Ersatzteile

Sıkma Vidası
Screw
Schraube

Tork Anahtar
Torx Key
Torx-Schlüssel

Takım Kodu Ordering Code Bestell-Bezeichnung	Stok Stock Lager	DC	ZEFP	DCON	LF	LH	APMX	Kesici Uç Insert Wendeschneidplatte	Sıkma Vidası Screw Schraube	Tork Anahtar Torx Key Torx-Schlüssel
AEM90-RT07-D10-W10-L120-Z02	●	10	2	10	120	30	7	RT 0702	3006-M2x4	82-T06
AEM90-RT07-D12-C12-L120-Z02	●	12	2	12	120	30	7			
AEM90-RT07-D12-W12-L120-Z02	●	12	2	12	120	30	7			
AEM90-RT07-D14-W12-L120-Z02	●	14	2	12	120	30	7			
AEM90-RT10-D16-C15-L160-Z02	●	16	2	15	160	30	10	RT 1003	3008-M2.5x6	82-T08
AEM90-RT10-D16-W16-L120-Z02-H	●	16	2	16	120	30	10			
AEM90-RT10-D16-W16-L150-Z02	●	16	2	16	150	30	10			
AEM90-RT10-D16-C16-L200-Z02	●	16	2	16	200	100	10			
AEM90-RT10-D17-W16-L160-Z02	●	17	2	16	160	30	10			
AEM90-RT10-D17-C16-L200-Z02	●	17	2	16	200	30	10			
AEM90-RT10-D18-W16-L120-Z02-H	●	18	2	16	120	30	10			
AEM90-RT10-D20-C19-L200-Z03	●	20	3	19	200	30	10			
AEM90-RT10-D20-C20-L110-Z03	●	20	3	20	110	30	10			
AEM90-RT10-D20-W20-L120-Z03-H	●	20	3	20	120	30	10			
AEM90-RT10-D20-W20-L150-Z03	●	20	3	20	150	50	10			
AEM90-RT10-D20-C20-L200-Z03	●	20	3	20	200	100	10			
AEM90-RT10-D21-W20-L200-Z03	●	21	3	20	200	30	10			
AEM90-RT10-D22-W20-L120-Z03-H	●	22	3	20	120	30	10			
AEM90-RT10-D22-C20-L150-Z03	●	22	3	20	150	30	10			
AEM90-RT10-D22-C20-L200-Z03	●	22	3	20	200	30	10			
AEM90-RT10-D25-W25-L120-Z04-H	●	25	4	25	120	40	10			
AEM90-RT10-D25-W25-L150-Z04	●	25	4	25	150	50	10			
AEM90-RT10-D25-C25-L200-Z04	●	25	4	25	200	100	10			
AEM90-RT10-D26-C25-L250-Z04	●	26	4	25	250	32	10			
AEM90-RT10-D32-W32-L120-Z05-H	●	32	5	32	120	50	10			
AEM90-RT10-D32-W32-L150-Z05	●	32	5	32	150	50	10			
AEM90-RT10-D32-C32-L200-Z05	●	32	5	32	200	100	10			
AEM90-RT10-D33-C32-L250-Z04	●	33	4	32	250	32	10			
AEM90-RT13-D32-C32-L250-Z04	●	32	4	32	250	50	13	RT 1304	3008-M3x8	
AEM90-RT16-D25-W25-L120-Z02-H	●	25	2	25	120	40	16	RT 1606	4015-M4x9	80-T15
AEM90-RT16-D25-W25-L150-Z02	●	25	2	25	150	50	16			
AEM90-RT16-D25-C25-L200-Z02	●	25	2	25	200	100	16			
AEM90-RT16-D32-W32-L120-Z03-H	●	32	3	32	120	50	16			
AEM90-RT16-D32-W32-L150-Z03	●	32	3	32	150	50	16			
AEM90-RT16-D32-C32-L200-Z03	●	32	3	32	200	100	16			
AEM90-RT16-D32-C32-L250-Z03	●	32	3	32	250	100	16			
AEM90-RT16-D32-C32-L270-Z03	●	32	3	32	270	100	16			
AEM90-RT16-D40-W32-L120-Z04-H	●	40	4	32	120	50	16			
AEM90-RT16-D40-W32-L150-Z04	●	40	4	32	150	50	16			
AEM90-RT16-D40-C32-L200-Z04	●	40	4	32	200	100	16		4015-M4x11	

R: Sağ / Right / Rechts/ L: Sol / Left / Links

● Stokta / In Stock / Auf Lager ○ Stokta Yok / Non Stock Item / Kein Lagerartikel, Lieferzeit auf Anfrage

SFTY Ucuna Uygundur. / Compatible with SFTY Insert. / Kompatibel mit SFTY Wendeplatten.

Sipariş Örneği/Ordering Example/Bestellbeispiel

1 ad./pcs./stück AEM90-RT07-D10-W10-L120-Z02

Kesme Hesabı : S 429 / Cutting Calculation : P 429 / Schnittberechnung : P 429

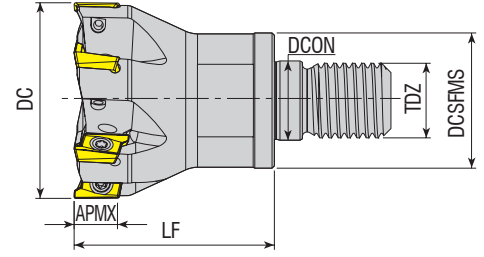

Takım Kodu Ordering Code Bestell-Bezeichnung	Stok Stock Lager	Takım Ölçüleri (mm) Dimension (mm) Abmessung (mm)							Kesici Uç Insert Wendeschneidplatte	Yedek Parçaları / Spare Parts / Ersatzteile		
		DC	ZEPF	DCSFMS	TDZ	LF	DCON	APMX		Sıkma Vidası Screw Schraube	Tork Anahtar Torx Key Torx-Schlüssel	
new AEM90-RT07-D13-M06-L20-Z02-H	●	13	2	11	M06	20	6.5	7	RT 0702..	3006-M2x4	82-T06	
AEM90-RT10-D16-M08-L20-Z02-H	●	16	2	14.75	M08	20	8.5	10				
new AEM90-RT10-D17-M08-L20-Z02-H	●	17	2	14.75	M08	20	8.5	7	RT 1003..	3008-M2.5x6	82-T08	
AEM90-RT10-D20-M10-L25-Z03-H	●	20	3	18	M10	25	10.5	10				
new AEM90-RT10-D21-M10-L25-Z03-H	●	21	3	18	M10	25	10.5	10				
new AEM90-RT10-D26-M12-L35-Z03-H	●	26	3	21	M12	35	12.5	10				
new AEM90-RT10-D26-M12-L35-Z04-H	●	26	4	21	M12	35	12.5	10				
AEM90-RT10-D25-M12-L30-Z04-H	●	25	4	21	M12	30	12.5	10				
AEM90-RT10-D32-M16-L43-Z05-H	●	32	5	29	M16	43	17	10				
AEM90-RT10-D42-M16-L43-Z06-H	●	42	6	29	M16	43	17	10				

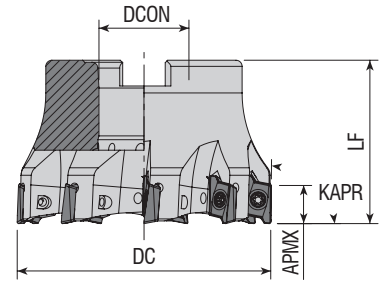

Takım Kodu Ordering Code Bestell-Bezeichnung	Stok Stock Lager	Takım Ölçüleri (mm) Dimension (mm) Abmessung (mm)					Kesici Uç Insert Wendeschneidplatte	Yedek Parçaları / Spare Parts / Ersatzteile			
		DC	ZEPF	DCON	LF	APMX		Sıkma Vidası Screw Schraube	Tork Anahtar Torx Key Torx-Schlüssel	Montaj Vidası Mounting Screw Befestigungsschraube	
AFM90-RT10-D040-A16-Z06-H	●	40	6	16	40	10	RT 1003	3008-M2.5x6	82-T08	2506-M8x30	
AFM90-RT10-D050-A22-Z07-H	●	50	7	22	40	10				2407-M10x30	
AFM90-RT10-D063-A22-Z09-H	●	63	9	22	40	10				-	
AFM90-RT16-D040-A16-Z04-H	●	40	4	16	40	16	RT 1606	4015-M4x11	80-T15	2506-M8x30	
AFM90-RT16-D063-A22-Z06-H	●	63	6	22	40	16				2508-M10x30	
AFM90-RT16-D080-A27-Z07-H	●	80	7	27	50	16				2510-M12x35	
AFM90-RT16-D125-B40-Z09	●	125	9	40	63	16				-	

R: Sağ / Right / Rechts L: Sol / Left / Links

● Stokta / In Stock / Auf Lager ○ Stokta Yok / Non Stock Item / Kein Lagerartikel, Lieferzeit auf Anfrage

SFTY Ucuna Uygundur. / Compatible with SFTY Insert. / Kompatibel mit SFTY Wendeplatten.

Sipariş Örneği/Ordering Example/Bestellbeispiel
1 ad./pcs./stück AEM90-RT07-D13-M06-L20-Z02-H

Kesme Hesabı : S 429 / Cutting Calculation : P 429 / Schnittberechnung : P 429
Montaj Ölçüleri : S 426 / Mounting Reference : P 426 / Montagehinweis : P 426

SMTM Ucuna Uygun. / Compatible with SMTM Insert. / Kompatibel mit SMTM Wendeplatten.

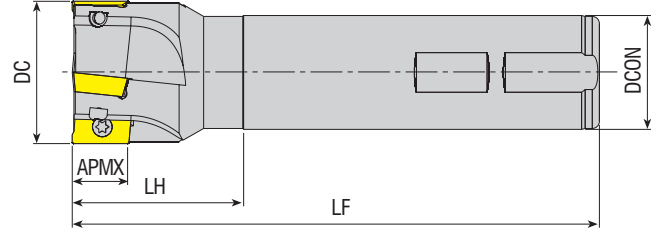

Takım Kodu Ordering Code Bestell-Bezeichnung	Stok Stock Lager	Takım Ölçüleri (mm) Dimension (mm) Abmessung (mm)						Kesici Uç Insert Wendeschneidplatte	Yedek Parçaları / Spare Parts / Ersatzteile	
		DC	ZEFP	DCON	LF	LH	APMX		Sıkma Vidası Screw Schraube	Tork Anahtar Torx Key Torx-Schlüssel
AEM90-AP10S-D16-W16-L150-Z02	●	16	2	16	150	26	10	AP.. 1003..	3008-M2.5x6	82-T08
AEM90-AP10S-D20-W20-L150-Z02	●	20	2	20	150	26	10		3008-M2.5x5	
AEM90-AP10S-D25-W25-L150-Z03	●	25	3	25	150	26	10			

R: Sağ / Right / Rechts/ L: Sol / Left / Links

● Stokta / In Stock / Auf Lager ○ Stokta Yok / Non Stock Item / Kein Lagerartikel, Lieferzeit auf Anfrage

SMTM Ucuna Uygun. / Compatible with SMTM Insert. / Kompatibel mit SMTM Wendeplatten.

Sipariş Örneği/Ordering Example/Bestellbeispiel

1 ad./pcs./stück AEM90-AP10S-D16-W16-L150-Z02

Kesme Hesabı : S 429 / Cutting Calculation : P 429 / Schnittberechnung : P 429



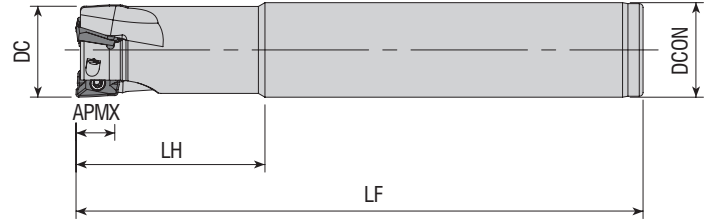

Takım Kodu Ordering Code Bestell-Bezeichnung	Stok Stock Lager	Takım Ölçüleri (mm) Dimension (mm) Abmessung (mm)						Kesici Uç Insert Wendeschneidplatte	Yedek Parçaları / Spare Parts / Ersatzteile		
		DC	ZEFP	DCON	LF	LH	APMX		Sıkma Vidası Screw Schraube	Tork Anahtar Torx Key Torx-Schlüssel	
AEM90-AX1235-D16-C14-L120-Z02-H	●	16	2	14	120	25	10	AX.T 1235..	3008-M3X6	82-T08	
AEM90-AX1235-D16-C15-L145-Z02-H	●	16	2	15	145	30	10				
AEM90-AX1235-D16-C16-L100-Z02-H	●	16	2	16	100	30	10				
AEM90-AX1235-D16-C16-L140-Z02-H	●	16	2	16	140	30	10				
AEM90-AX1235-D16-C16-L145-Z02-H	●	16	2	16	145	30	10				
AEM90-AX1235-D16-C16-L150-Z02	●	16	2	16	150	30	10				
AEM90-AX1235-D20-C19-L150-Z02-H	●	20	2	19	150	40	10				
AEM90-AX1235-D20-C20-L110-Z03-H	●	20	3	20	110	40	10				
AEM90-AX1235-D20-C20-L150-Z02	●	20	2	20	150	40	10				
AEM90-AX1235-D20-C20-L150-Z02-H	●	20	2	20	150	40	10				
AEM90-AX1235-D20-C20-L150-Z03	●	20	3	20	150	40	10				
AEM90-AX1235-D25-C20-L120-Z04-H	●	25	4	20	120	30	10				
AEM90-AX1235-D25-C20-L150-Z04-H	●	25	4	20	150	30	10				
AEM90-AX1235-D25-C24-L170-Z02-H	●	25	2	24	170	50	10				
AEM90-AX1235-D25-C25-L120-Z04-H	●	25	4	25	120	40	10				
AEM90-AX1235-D25-C25-L150-Z03	●	25	3	25	150	50	10				
AEM90-AX1235-D25-C25-L170-Z02-H	●	25	2	25	170	50	10				
AEM90-AX1235-D25-W25-L100-Z04-H	●	25	4	25	100	30	10				
AEM90-AX1235-D32-C32-L130-Z05-H	●	32	5	32	130	40	10				
AEM90-AX1235-D32-C32-L180-Z02-H	●	32	2	32	180	50	10				
AEM90-AX1705-D25-C25-L150-Z02	●	25	2	25	150	50	14	AX.T 1705..		80-T15	
AEM90-AX1705-D28-W25-L115-Z02-H	●	28	2	25	115	35	14				
AEM90-AX1705-D32-C32-L150-Z03	●	32	3	32	150	50	14				
AEM90-AX1705-D32-C32-L180-Z02-H	●	32	2	32	180	50	14				

R: Sağ / Right / Rechts/ L: Sol / Left / Links

● Stokta / In Stock / Auf Lager ○ Stokta Yok / Non Stock Item / Kein Lagerartikel, Lieferzeit auf Anfrage

SMTM Ucuna Uygundur. / Compatible with SMTM Insert. / Kompatibel mit SMTM Wendeplatten.

Sipariş Örneği/Ordering Example/Bestellbeispiel
1 ad./pcs./stück AEM90-AX1235-D16-C14-L120-Z02-H
Kesme Hesabı : S 429 / Cutting Calculation : P 429 / Schnittberechnung : P 429

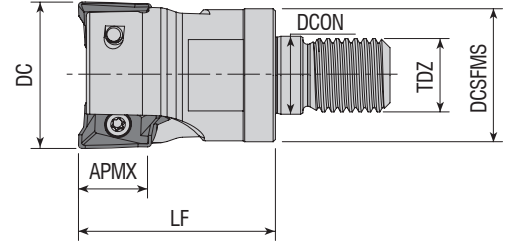

Takım Kodu Ordering Code Bestell-Bezeichnung	Stok Stock Lager	Takım Ölçüleri (mm) Dimension (mm) Abmessung (mm)							Kesici Uç Insert Wendeschneidplatte	Yedek Parçaları / Spare Parts / Ersatzteile		
		DC	ZEPF	DCSFMS	TDZ	LF	DCON	APMX		Sıkma Vidası Screw Schraube	Tork Anahtar Torx Key Torx-Schlüssel	
AEM90-AX1235-D16-M08-L30-Z02-H	●	16	2	14.75	M08	30	8.5	10	AX.T 1235..		82-T08	
AEM90-AX1235-D20-M10-L30-Z03-H	●	20	3	18	M10	30	10.5	10				
AEM90-AX1235-D25-M12-L35-Z04-H	●	25	4	21	M12	35	12.5	10				
AEM90-AX1705-D25-M12-L43-Z02-H	●	25	2	21	M12	43	12.5	14	AX.T 1705..	4015-M4x9	80-T15	
AEM90-AX1705-D32-M16-L43-Z02-H	●	32	2	29	M16	43	17	14				

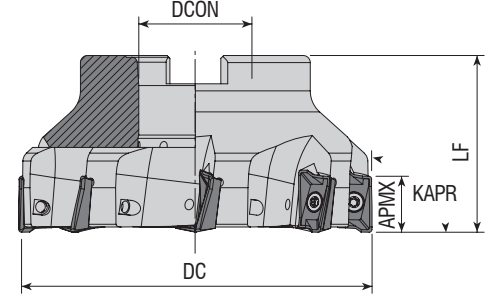

Takım Kodu Ordering Code Bestell-Bezeichnung	Stok Stock Lager	Takım Ölçüleri (mm) Dimension (mm) Abmessung (mm)					Kesici Uç Insert Wendeschneidplatte	Yedek Parçaları / Spare Parts / Ersatzteile			
		DC	ZEPF	DCON	LF	APMX		Sıkma Vidası Screw Schraube	Tork Anahtar Torx Key Torx-Schlüssel	Montaj Vidası Mounting Screw Befestigungsschraube	
AFM90-AX1235-D040-A16-Z06-H	●	40	6	16	40	10	AX.T 1235..		82-T08	2506-M8x30	
AFM90-AX1235-D050-A22-Z07-H	●	50	7	22	40	10				2508-M10x30	
AFM90-AX1235-D063-A22-Z08-H	●	63	8	22	40	10				2510-M12x35	
AFM90-AX1235-D080-A27-Z10-H	●	80	10	27	50	10				2506-M8x30	
AFM90-AX1705-D040-A16-Z04-H	●	40	4	16	40	14	AX.T 1705..	4015-M4x11	80-T15	2508-M10x30	
AFM90-AX1705-D050-A22-Z05-H	●	50	5	22	40	14				2510-M12x35	
AFM90-AX1705-D063-A22-Z06-H	●	63	6	22	40	14				2514-M16x35	
AFM90-AX1705-D080-A27-Z07-H	●	80	7	27	50	14					
AFM90-AX1705-D100-A32-Z08-H	●	100	8	32	50	14					

R: Sağ / Right / Rechts/ L: Sol / Left / Links

● Stokta / In Stock / Auf Lager ○ Stokta Yok / Non Stock Item / Kein Lagerartikel, Lieferzeit auf Anfrage

SMTM Ucuna Uygun. / Compatible with SMTM Insert. / Kompatibel mit SMTM Wendeplatten.

Sipariş Örneği/Ordering Example/Bestellbeispiel

1 ad./pcs./stück AEM90-AX1235-D16-M08-L30-Z02-H

Kesme Hesabı : S 429 / Cutting Calculation : P 429 / Schnittberechnung : P 429

Sıkma Tork Değeri : S 416 / Tightening Torque : P 416 / Anzugsmoment : P 416

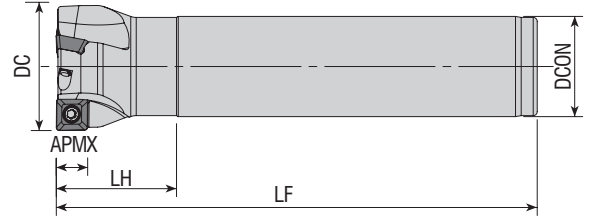

Takım Kodu Ordering Code Bestell-Bezeichnung	Stok Stock Lager	Takım Ölçüleri (mm) Dimension (mm) Abmessung (mm)						Kesici Uç Insert Wendeschneidplatte	Yedek Parçaları / Spare Parts / Ersatzteile		
		DC	ZEFP	DCON	LF	LH	APMX		Sıkma Vidası Screw Schraube	Baskı Parçası Wedge Clamp Spannpratze	Tork Anahtar Torx Key Torx-Schlüssel
AEM90-S00803-D20-C16-L110-Z02-H	●	20	2	16	110	25	7	SOMT 0803..	3008-M3x7	82-T08	
AEM90-S00803-D25-C20-L110-Z02-H	●	25	2	20	110	25	7				
AEM90-S00803-D32-C25-L120-Z03-H	●	32	3	25	120	30	7				

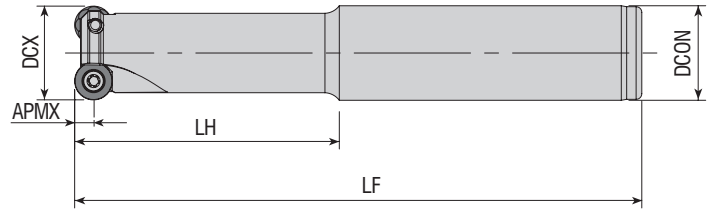

Takım Kodu Ordering Code Bestell-Bezeichnung	Stok Stock Lager	Takım Ölçüleri (mm) Dimension (mm) Abmessung (mm)						Kesici Uç Insert Wendeschneidplatte	Yedek Parçaları / Spare Parts / Ersatzteile			
		DCX	ZEFP	DCON	LF	LH	APMX		Sıkma Vidası Screw Schraube	Baskı Parçası Wedge Clamp Spannpratze	Baskı Vidası Clamp Screw Schraube	Tork Anahtar Torx Key Torx-Schlüssel
AEMR-QP10T3-D20-C20-L150-Z01-H	●	20	1	20	150	70	5	QP. 10T3..	4015-M3.5x9	-	-	80-T15
AEMR-QP10T3-D25-C25-L120-Z02-H	●	25	2	25	120	40	5					
AEMR-QP10T3-D25-C25-L150-Z02-H	●	25	2	25	150	70	5					
AEMR-QP10T3-D25-C25-L170-Z02	●	25	2	25	170	90	5					
AEMR-QP10T3-D32-C32-L150-Z03-H	●	32	3	32	150	70	5					
AEMR-QP10T3-D32-C32-L170-Z03	●	32	3	32	170	90	5					
AEMR-QP1204-D25-C25-L150-Z02-H	●	25	2	25	150	70	6	QP. 1204..	4015-M4x9	-	-	

R: Sağ / Right / Rechts L: Sol / Left / Links

● Stokta / In Stock / Auf Lager ○ Stokta Yok / Non Stock Item / Kein Lagerartikel, Lieferzeit auf Anfrage

SMTM Ucuna Uygundur. / Compatible with SMTM Insert. / Kompatibel mit SMTM Wendeplatten.

Sipariş Örneği/Ordering Example/Bestellbeispiel

1 ad./pcs./stück AEM90-S00803-D20-C16-L110-Z02-H

Kesme Hesabı : S 429 / Cutting Calculation : P 429 / Schnittberechnung : P 429

Montaj Ölçüleri : S 426 / Mounting Reference : P 426 / Montagehinweis : P 426

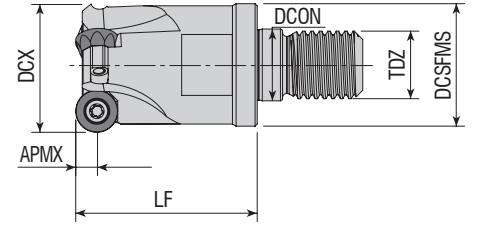

Takım Kodu Ordering Code Bestell-Bezeichnung	Stok Stock Lager	Takım Ölçüleri (mm) Dimension (mm) Abmessung (mm)							Kesici Uç Insert Wendeschneidplatte	Yedek Parçaları / Spare Parts / Ersatzteile		
		DCX	ZEFP	DCSFMS	TDZ	LF	DCON	APMX		Sıkma Vidası Screw Schraube	Tork Anahtar Torx Key Torx-Schlüssel	
AEMR-QP10T3-D25-M12-L35-Z02-H	●	25	2	21	M12	35	12.5	5				
AEMR-QP10T3-D32-M16-L43-Z03-H	●	32	3	29	M16	43	17	5				QP. 10T3..

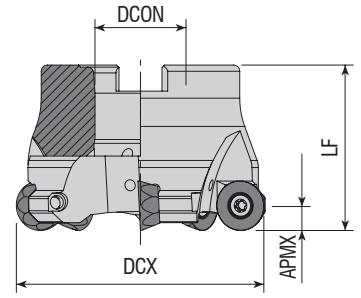

Takım Kodu Ordering Code Bestell-Bezeichnung	Stok Stock Lager	Takım Ölçüleri (mm) Dimension (mm) Abmessung (mm)					Kesici Uç Insert Wendeschneidplatte	Yedek Parçaları / Spare Parts / Ersatzteile					
		DCX	ZEFP	DCON	LF	APMX		Sıkma Vidası Screw Schraube	Tork Anahtar Torx Key Torx-Schlüssel	Montaj Vidası Mounting Screw Befestigungsschraube			
AFMR-QP10T3-D040-A16-Z04-H	●	40	4	16	40	5							
AFMR-QP10T3-D050-A22-Z05-H	●	50	5	22	40	5					QP. 10T3..	4015-M3.5x11	2506-M8x30
AFMR-QP10T3-D063-A22-Z06-H	●	63	6	22	40	5					QP. 1204..	4015-M4x11	2407-M10x30
AFMR-QP1204-D050-A22-Z04-H	●	50	4	22	40	6			80-T15				
AFMR-QP1204-D063-A22-Z05-H	●	63	5	22	40	6							

R: Sağ / Right / Rechts/ L: Sol / Left / Links

● Stokta / In Stock / Auf Lager ○ Stokta Yok / Non Stock Item / Kein Lagerartikel, Lieferzeit auf Anfrage

SMTM Ucuna Uygun. / Compatible with SMTM Insert. / Kompatibel mit SMTM Wendeplatten.

Sipariş Örneği/Ordering Example/Bestellbeispiel

1 ad./pcs./stück AEMR-QP10T3-D25-M12-L35-Z02-H

Kesme Hesabı : S 429 / Cutting Calculation : P 429 / Schnittberechnung : P 429

SMTM Ucuna Uygun. / Compatible with SMTM Insert. / Kompatibel mit SMTM Wendeplatten.

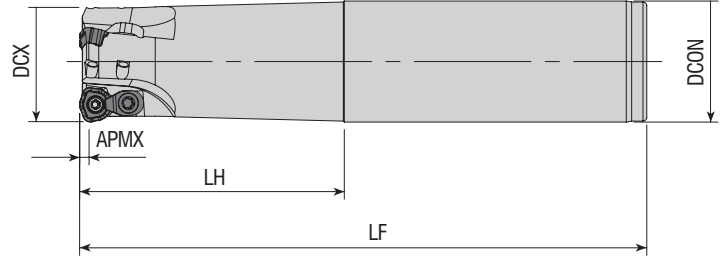

Takım Kodu Ordering Code Bestell-Bezeichnung	Stok Stock Lager	Takım Ölçüleri (mm) Dimension (mm) Abmessung (mm)						Kesici Uç Insert Wendeschneidplatte	Yedek Parçaları / Spare Parts / Ersatzteile			
		DCX	ZEFP	DCON	LF	LH	APMX		Sıkma Vidası Screw Schraube	Baskı Parçası Wedge Clamp Spannpratze	Baskı Vidası Clamp Screw Schraube	Tork Anahtar Torx Key Torx-Schlüssel
AHFM-WD0603-D16-C16-L150-Z02	●	16	2	16	150	70	2			-	-	
AHFM-WD0603-D20-C20-L150-Z03	●	20	3	20	150	70	2					
AHFMC-WD0804-D25-C25-L150-Z02	●	25	2	25	150	60	1.5					
AHFMC-WD0804-D32-C32-L150-Z03	●	32	3	32	150	70	1.5					
AHFMC-WD1205-D32-C32-L150-Z02	●	32	2	32	150	70	3					

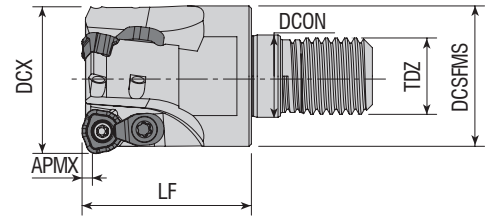

Takım Kodu Ordering Code Bestell-Bezeichnung	Stok Stock Lager	Takım Ölçüleri (mm) Dimension (mm) Abmessung (mm)							Kesici Uç Insert Wendeschneidplatte	Yedek Parçaları / Spare Parts / Ersatzteile			
		DCX	ZEFP	DCSFMS	TDZ	LF	DCON	APMX		Sıkma Vidası Screw Schraube	Baskı Parçası Wedge Clamp Spannpratze	Baskı Vidası Clamp Screw Schraube	Tork Anahtar Torx Key Torx-Schlüssel
AHFMC-WD0804-D25-M12-L35-Z02-H	●	25	2	21	M12	35	12.5	1.5					
AHFMC-WD0804-D32-M16-L35-Z03-H	●	32	3	29	M16	35	17	1.5					

R: Sağ / Right / Rechts/ L: Sol / Left / Links

● Stokta / In Stock / Auf Lager ○ Stokta Yok / Non Stock Item / Kein Lagerartikel, Lieferzeit auf Anfrage

SMTM Ucuna Uygun. / Compatible with SMTM Insert. / Kompatibel mit SMTM Wendeplatten.

Sipariş Örneği/Ordering Example/Bestellbeispiel

1 ad./pcs./stück AHFM-WD0603-D16-C16-L150-Z02

Kesme Hesabı : S 429 / Cutting Calculation : P 429 / Schnittberechnung : P 429

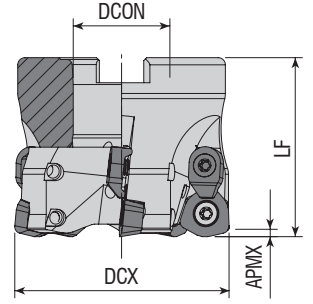

Takım Kodu Ordering Code Bestell-Bezeichnung	Stok Stock Lager	Takım Ölçüleri (mm) Dimension (mm) Abmessung (mm)					Kesici Uç Insert Wendeschneidplatte	Yedek Parçaları / Spare Parts / Ersatzteile				
		DCX	ZEFP	DCON	LF	APMX		Sıkma Vidası Screw Schraube	Baskı Pabucu Wedge Clamp Spannpratze	Baskı Vidası Clamp Screw Klemmschraube	Tork Anahtar Torx Key Torx-Schlüssel	Montaj Vidası Mounting Screw Befestigungsschraube
AHFMC-WD0804-D040-A16-Z04-H	●	40	4	16	40	1.5	WDMT 0804..	4010-M3x8	ACK-15	4010-M3x8	82-T10	2506-M8x30
AHFMC-WD0804-D050-A22-Z04-H	●	50	4	22	50	1.5						
AHFMC-WD1205-D050-A22-Z04-H	●	50	4	22	50	3	WDMT 1205..	1415-M4x11	ACK-05	4015-M4x11	80-T15	2508-M10x30
AHFMC-WD1205-D052-A22-Z04-H	●	52	4	22	50	3						
AHFMC-WD1205-D063-A22-Z05-H	●	63	5	22	50	3						
AHFMC-WD1205-D080-A27-Z06-H	●	80	6	27	63	3						

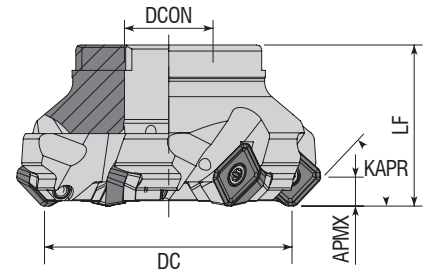

Takım Kodu Ordering Code Bestell-Bezeichnung	Stok Stock Lager	Takım Ölçüleri (mm) Dimension (mm) Abmessung (mm)					Kesici Uç Insert Wendeschneidplatte	Yedek Parçaları / Spare Parts / Ersatzteile							
		DC	ZEFP	DCON	LF	APMX		Altık Screw Unterlage	Altık Vidası Wedge Clamp Vint опорной пластины	Sıkma Vidası Screw Schraube	Tork Anahtar Torx Key Torx-Schlüssel	Montaj Vidası Mounting Screw Befestigungsschraube			
AFM45-SE13-D050-A22-Z04-H	●	50	4	22	40	6	SEMT 13T3..	AASE-3-0001	AAV-16-M3.5x8	4015-M3.5x12	80-T15	2407-M10x30			
AFM45-SE13-D063-A22-Z05-H	●	63	5	22	40	6						-	-	4015-M3.5x11	2510-M12x35
AFM45-SE13-D080-A27-Z06-H	●	80	6	27	50	6						-	-	-	2407-M10x30
AFM45S-SE13-D050-A22-Z05-H	●	50	5	22	40	6						-	-	-	2510-M12x35
AFM45S-SE13-D063-A22-Z06-H	●	63	6	22	40	6						-	-	-	2514-M16x35
AFM45S-SE13-D080-A27-Z08-H	●	80	8	27	50	6						-	-	-	-
AFM45S-SE13-D100-A32-Z10-H	●	100	10	32	50	6						-	-	-	-
AFM45S-SE13-D125-B40-Z12	●	125	12	40	63	6						-	-	-	-

R: Sağ / Right / Rechts/ L: Sol / Left / Links

● Stokta / In Stock / Auf Lager ○ Stokta Yok / Non Stock Item / Kein Lagerartikel, Lieferzeit auf Anfrage

SMTM Ucuna Uygundur. / Compatible with SMTM Insert. / Kompatibel mit SMTM Wendeplatten.

Sipariş Örneği/Ordering Example/Bestellbeispiel

1 ad./pcs./stück AHFMC-WD0804-D040-A16-Z04-H

Kesme Hesabı : S 429 / Cutting Calculation : P 429 / Schnittberechnung : P 429

SNDVK Ucuna Uygun. / Compatible with SNDVK Insert. / Kompatibel mit SNDVK Wendeplatten.

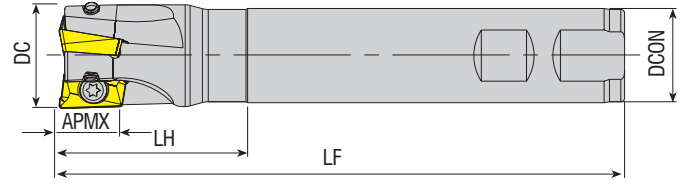

Takım Kodu Ordering Code Bestell-Bezeichnung	Stok Stock Lager	Takım Ölçüleri (mm) Dimension (mm) Abmessung (mm)						Kesici Uç Insert Wendeschneidplatte	Yedek Parçaları / Spare Parts / Ersatzteile	
		DC	ZEFP	DCON	LF	LH	APMX		Sıkma Vidası Screw Schraube	Tork Anahtar Torx Key Torx-Schlüssel
AEM90-R390.11-D12-W12-L100-Z01	●	12	1	12	100	25	10	R390-11T3..	3008-M2.5x5	82-T08
AEM90-R390.11-D16-W16-L100-Z02-H	●	16	2	16	100	30	10			
AEM90-R390.11-D16-W16-L150-Z02	●	16	2	16	150	50	10			
AEM90-R390.11-D16-W16-L150-Z02-H	●	16	2	16	150	50	10			
AEM90-R390.11-D20-W20-L090-Z02-H	●	20	2	20	90	30	10			
AEM90-R390.11-D20-W20-L100-Z03-H	●	20	3	20	100	30	10			
AEM90-R390.11-D20-W20-L150-Z03	●	20	3	20	150	50	10			
AEM90-R390.11-D20-W20-L150-Z03-H	●	20	3	20	150	50	10			
AEM90-R390.11-D20-C20-L150-Z03	●	20	3	20	150	30	10			
AEM90-R390.11-D22-W20-L090-Z02-H	●	22	2	20	90	30	10			
AEM90-R390.11-D25-C20-L150-Z03	●	25	3	20	150	40	10			
AEM90-R390.11-D25-W25-L100-Z03-H	●	25	3	25	100	30	10			
AEM90-R390.11-D25-W25-L150-Z03	●	25	3	25	150	50	10			
AEM90-R390.11-D25-W25-L150-Z03-H	●	25	3	25	150	50	10			
AEM90-R390.11-D30-W25-L150-Z04-H	●	30	4	25	150	30	10			
AEM90-R390.11-D32-C25-L200-Z03	●	32	3	25	200	40	10			
AEM90-R390.11-D32-W32-L150-Z05-H	●	32	5	32	150	50	10			
AEM90-R390.17-D25-W25-L150-Z02	●	25	2	25	150	50	15.4	R390-1704..	4015-M3.5x8	80-T15
AEM90-R390.17-D25-W25-L150-Z02-H	●	25	2	25	150	50	15.4		4015-M3.5x9	
AEM90-R390.17-D30-W25-L150-Z03	●	30	3	25	150	40	15.4		4015-M3.5x9	
AEM90-R390.17-D30-W25-L150-Z03-H	●	30	3	25	150	40	15.4		4015-M4x11	
AEM90-R390.18-D32-C32-L150-Z03	●	32	3	32	150	45	15.4	R390-1806..	4015-M4x11	
AEM90-R390.18-D40-C32-L150-Z04-H	●	40	4	32	150	40	15.4			

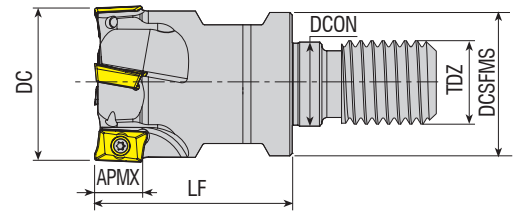

Takım Kodu Ordering Code Bestell-Bezeichnung	Stok Stock Lager	Takım Ölçüleri (mm) Dimension (mm) Abmessung (mm)							Kesici Uç Insert Wendeschneidplatte	Yedek Parçaları / Spare Parts / Ersatzteile	
		DC	ZEFP	DCSFMS	TDZ	LF	DCON	APMX		Sıkma Vidası Screw Schraube	Tork Anahtar Torx Key Torx-Schlüssel
AEM90-R390.11-D16-M08-L30-Z02-H	●	16	2	14.75	M08	30	8.5	10	R390-11T3..	3008-M2.5x5	82-T08
AEM90-R390.11-D20-M10-L30-Z03-H	●	20	3	18	M10	30	10.5	10			
AEM90-R390.11-D25-M12-L35-Z03-H	●	25	3	21	M12	35	12.5	10			
AEM90-R390.11-D32-M16-L43-Z04-H	●	32	4	29	M16	43	17	10			

R: Sağ / Right / Rechts/ L: Sol / Left / Links

● Stokta / In Stock / Auf Lager ○ Stokta Yok / Non Stock Item / Kein Lagerartikel, Lieferzeit auf Anfrage

SNDVK Ucuna Uygun. / Compatible with SNDVK Insert. / Kompatibel mit SNDVK Wendeplatten.

Sipariş Örneği/Ordering Example/Bestellbeispiel

1 ad./pcs./stück AEM90-R390.11-D12-W12-L100-Z01

Kesme Hesabı : S 429 / Cutting Calculation : P 429 / Schnittberechnung : P 429

Sıkma Tork Değeri : S 428 / Tightening Torque : P 428 / Anzugsmoment : P 428

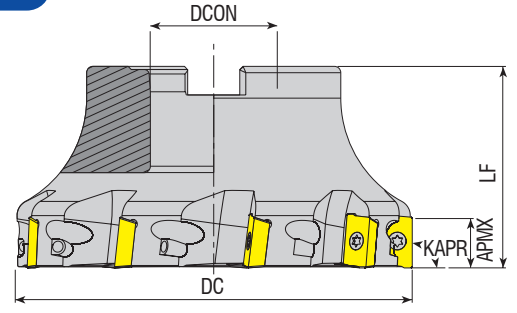

Takım Kodu
Ordering Code
Bestell-Bezeichnung

Stok
Stock
Lager

Takım Ölçüleri (mm)
Dimension (mm)
Abmessung (mm)

Kesici Uç
Insert
Wendeschneidplatte

Yedek Parçaları / Spare Parts / Ersatzteile

Sıkma Vidası
Screw
Schraube

Tork Anahtar
Torx Key
Torx-Schlüssel

Montaj Vidası
Mounting Screw
Befestigungsschraube

DC ZEFP DCON LF APMX



AFM90-R390.11-D040-A16-Z05-H	●	40	5	16	40	10
AFM90-R390.11-D050-A22-Z06-H	●	50	6	22	40	10
AFM90-R390.11-D063-A22-Z07-H	●	63	7	22	40	10
AFM90-R390.11-D080-A27-Z09-H	●	80	9	27	50	10
AFM90-R390.17-D040-A16-Z04-H	●	40	4	16	40	15.4
AFM90-R390.17-D050-A22-Z05-H	●	50	5	22	40	15.4
AFM90-R390.17-D063-A22-Z06-H	●	63	6	22	40	15.4
AFM90-R390.17-D080-A27-Z07-H	●	80	7	27	50	15.4
AFM90-R390.17-D100-A32-Z08-H	●	100	8	32	50	15.4
AFM90-R390.17-D125-B40-Z09	●	125	9	40	63	15.4
AFM90-R390.18-D050-A22-Z04-H	●	50	4	22	40	15.4
AFM90-R390.18-D063-A22-Z05-H	●	63	5	22	40	15.4
AFM90-R390.18-D080-A27-Z06-H	●	80	6	27	50	15.4
AFM90-R390.18-D100-A32-Z07-H	●	100	7	32	50	15.4
AFM90-R390.18-D125-B40-Z08	●	125	8	40	63	15.4

R390-11T3..

3008-M2.5x6

82-T08

2506-M8x30

2508-M10x30

2510-M12x35

2506-M8x30

2508-M10x30

2510-M12x35

2514-M16x35

-

R390-1704..

4015-M3.5x11

80-T15

2508-M10x30

2510-M12x35

2514-M16x35

-

R390-1806..

4015-M4x11

2508-M10x30

2510-M12x35

2514-M16x35

-

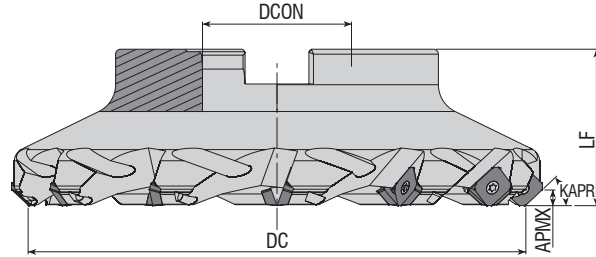

Takım Kodu
Ordering Code
Bestell-Bezeichnung

Stok
Stock
Lager

Takım Ölçüleri (mm)
Dimension (mm)
Abmessung (mm)

Kesici Uç
Insert
Wendeschneidplatte

Yedek Parçaları / Spare Parts / Ersatzteile

Sıkma Vidası
Screw
Schraube

Tork Anahtar
Torx Key
Torx-Schlüssel

Montaj Vidası
Mounting Screw
Befestigungsschraube

DC ZEFP DCON LF APMX

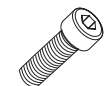
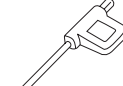

AFM45-SE12-D050-A22-Z04-H	●	50	4	22	40	6
AFM45L-SE12-D050-A22-Z04-H	●	50	4	22	40	6
AFM45-SE12-D063-A22-Z05-H	●	63	5	22	40	6
AFM45L-SE12-D063-A22-Z05-H	●	63	5	22	40	6
AFM45-SE12-D080-A27-Z06-H	●	80	6	27	50	6
AFM45L-SE12-D080-A27-Z06-H	●	80	6	27	50	6
AFM45-SE12-D100-A32-Z07-H	●	100	7	32	50	6
AFM45-SE12-D125-B40-Z08	●	125	8	40	63	6
AFM45-SE12-D160-C40-Z10	●	160	10	40	63	6
AFM45L-SE12-D160-C40-Z10	●	160	10	40	63	6
AFM45-SE12-D200-C60-Z12	●	200	12	60	63	6

SE.. 12T3..

R245-12T3..

4015-M3.5x11

80-T15

2407-M10x30

2510-M12x35

2514-M16x35

-

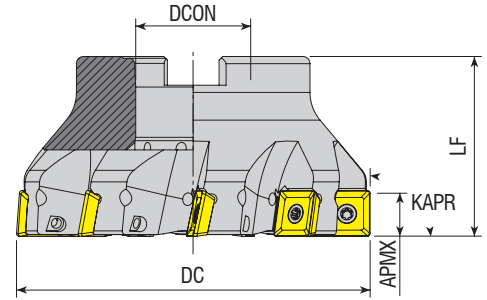
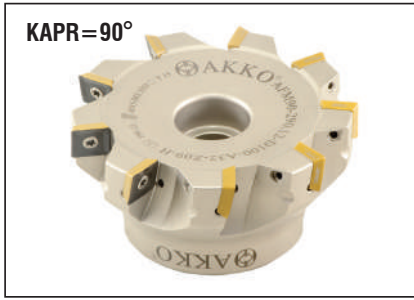

Takım Kodu Ordering Code Bestell-Bezeichnung	Stok Stock Lager	Takım Ölçüleri (mm) Dimension (mm) Abmessung (mm)					Kesici Uç Insert Wendeschneidplatte	Yedek Parçaları / Spare Parts / Ersatzteile		
		DC	ZEFP	DCON	LF	APMX		Sıkma Vidası Screw Schraube	Tork Anahtar Torx Key Torx-Schlüssel	Montaj Vidası Mounting Screw Befestigungsschraube
AFM90-R290.12-D050-A22-Z04-H	●	50	4	22	40	10.7	R290-12T3..	4015-M3.5x11	80-T15	2508-M10x30
AFM90-R290.12-D063-A22-Z05-H	●	63	5	22	40	10.7				2510-M12x35
AFM90-R290.12-D080-A27-Z07-H	●	80	7	27	50	10.7				2514-M16x35
AFM90-R290.12-D100-A32-Z09-H	●	100	9	32	50	10.7				-
AFM90-R290.12-D125-B40-Z11	●	125	11	40	63	10.7				-

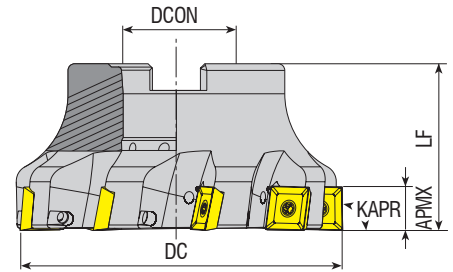
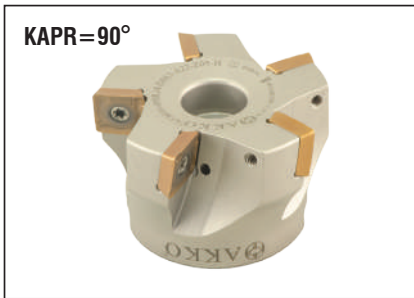

Takım Kodu Ordering Code Bestell-Bezeichnung	Stok Stock Lager	Takım Ölçüleri (mm) Dimension (mm) Abmessung (mm)					Kesici Uç Insert Wendeschneidplatte	Yedek Parçaları / Spare Parts / Ersatzteile		
		DC	ZEFP	DCON	LF	APMX		Sıkma Vidası Screw Schraube	Tork Anahtar Torx Key Torx-Schlüssel	Montaj Vidası Mounting Screw Befestigungsschraube
AFM90-490R08-D063-A22-Z06-H	●	63	6	22	40	5.5	490R-08T3..	3008-M2.5x6	82-T08	2508-M10x30
AFM90-490R14-D050-A22-Z04-H	●	50	4	22	40	10				2510-M12x35
AFM90-490R14-D063-A22-Z05-H	●	63	5	22	40	10	490R-1404..	4015-M3.5x11	80-T15	2514-M16x35
AFM90-490R14-D080-A27-Z07-H	●	80	7	27	50	10				-
AFM90-490R14-D100-A32-Z07-H	●	100	7	32	50	10				-
AFM90-490R14-D125-B40-Z08	●	125	8	40	63	10				-
AFM90-490R14-D125-B40-Z12	●	125	12	40	63	10				-
AFM90-490R14-D160-C40-Z12	●	160	12	40	63	10	-			
AFM90-490R14-D200-C60-Z16	●	200	16	60	63	10	-			

R: Sağ / Right / Rechts/ L: Sol / Left / Links

● Stokta / In Stock / Auf Lager ○ Stokta Yok / Non Stock Item / Kein Lagerartikel, Lieferzeit auf Anfrage

SNDVK Ucuna Uygun. / Compatible with SNDVK Insert. / Kompatibel mit SNDVK Wendeplatten.

Sipariş Örneği/Ordering Example/Bestellbeispiel

1 ad./pcs./stück AFM90-R290.12-D050-A22-Z04-H

Kesme Hesabı : S 429 / Cutting Calculation : P 429 / Schnittberechnung : P 429

Sıkma Tork Değeri : S 428 / Tightening Torque : P 428 / Anzugsmoment : P 428

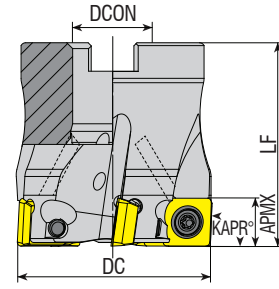

Takım Kodu Ordering Code Bestell-Bezeichnung	Stok Stock Lager	Takım Ölçüleri (mm) Dimension (mm) Abmessung (mm)					Kesici Uç Insert Wendeschneidplatte	Yedek Parçaları / Spare Parts / Ersatzteile		
		DC	ZEFP	DCON	LF	APMX		Sıkma Vidası Screw Schraube	Tork Anahtar Torx Key Torx-Schlüssel	Montaj Vidası Mounting Screw Befestigungsschraube
AFM90-SP09T3-D040-A16-Z05-H	●	40	5	16	40	8.6	SPMT 09T3..	3010-M3.5x9	82-T10	2506-M8x30
AFM90-SP09T3-D050-A22-Z06-H	●	50	6	22	40	8.6				2508-M10x30
AFM90-SP09T3-D063-A22-Z07-H	●	63	7	22	40	8.6				2510-M12x35
AFM90-SP09T3-D080-A27-Z08-H	●	80	8	27	50	8.6				

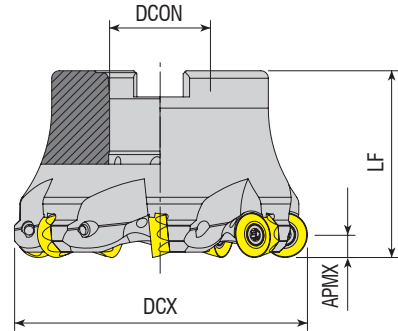

Takım Kodu Ordering Code Bestell-Bezeichnung	Stok Stock Lager	Takım Ölçüleri (mm) Dimension (mm) Abmessung (mm)					Kesici Uç Insert Wendeschneidplatte	Yedek Parçaları / Spare Parts / Ersatzteile		
		DCX	ZEFP	DCON	LF	APMX		Sıkma Vidası Screw Schraube	Tork Anahtar Torx Key Torx-Schlüssel	Montaj Vidası Mounting Screw Befestigungsschraube
AFMR-RC1204-D040-A16-Z04-H	●	40	4	16	40	6	RC.. 1204..	4015-M3.5x11	80-T15	2506-M8x30
AFMR-RC1204-D050-A22-Z05-H	●	50	5	22	50	6				2508-M10x30
AFMR-RC1204-D052-A22-Z05-H	●	52	5	22	50	6				2510-M12x35
AFMR-RC1204-D063-A22-Z06-H	●	63	6	22	50	6				
AFMR-RC1204-D063-A27-Z06-H	●	63	6	27	50	6				
AFMR-RC1204-D080-A27-Z07-H	●	80	7	27	50	6				

R: Sağ / Right / Rechts L: Sol / Left / Links

● Stokta / In Stock / Auf Lager ○ Stokta Yok / Non Stock Item / Kein Lagerartikel, Lieferzeit auf Anfrage

SNDVK Ucuna Uygunudur. / Compatible with SNDVK Insert. / Kompatibel mit SNDVK Wendeplatten.

Sipariş Örneği/Ordering Example/Bestellbeispiel

1 ad./pcs./stück AFM90-SP09T3-D040-A16-Z05-H

Kesme Hesabı : S 429 / Cutting Calculation : P 429 / Schnittberechnung : P 429

Montaj Ölçüleri : S 426 / Mounting Reference : P 426 / Montagehinweis : P426

TGTC Ucuna Uygundur. / Compatible with TGTC Insert. / Kompatibel mit TGTC Wendeplatten.

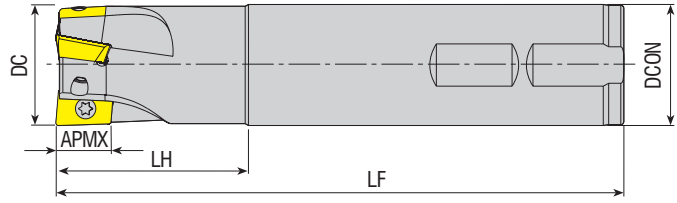

Takım Kodu Ordering Code Bestell-Bezeichnung	Stok Stock Lager	Takım Ölçüleri (mm) Dimension (mm) Abmessung (mm)						Kesici Uç Insert Wendeschneidplatte	Yedek Parçaları / Spare Parts / Ersatzteile	
		DC	ZEFP	DCON	LF	LH	APMX		Sıkma Vidası Screw Schraube	Tork Anahtar Torx Key Torx-Schlüssel
AEM90-AX0602-D10-C09-L120-Z02	●	10	2	9	120	20	5.7	AX.. 0602	3006-M1.8x4	82-T06
AEM90-AX0602-D10-C10-L080-Z02	●	10	2	10	80	20	5.7			
AEM90-AX0602-D10-C10-L120-Z02	●	10	2	10	120	20	5.7			
AEM90-AX0602-D12-C11-L120-Z02	●	12	2	11	120	20	5.7			
AEM90-AX0602-D12-C12-L080-Z02	●	12	2	12	80	20	5.7			
AEM90-AX0602-D12-C12-L120-Z02	●	12	2	12	120	20	5.7			
AEM90-AX0602-D14-C12-L120-Z03	●	14	3	12	120	20	5.7			
AEM90-AX0602-D16-W16-L120-Z04-H	●	16	4	16	120	20	5.7			
AEM90-AX0602-D16-W16-L150-Z04-H	●	16	4	16	150	20	5.7			
AEM90-AX0602-D20-W20-L120-Z05-H	●	20	5	20	120	25	5.7			
AEM90-AX0602-D20-W20-L150-Z05-H	●	20	5	20	150	25	5.7			
AEM90-AX0903-D16-C16-L120-Z02	●	16	2	16	120	30	8.8			
AEM90-AX0903-D16-C16-L180-Z02	●	16	2	16	180	30	8.8			
AEM90-AX0903-D17-C16-L120-Z02	●	17	2	16	120	25	8.8			
AEM90-AX0903-D17-C16-L180-Z02	●	17	2	16	180	25	8.8			
AEM90-AX0903-D20-C20-L120-Z03	●	20	3	20	120	30	8.8			
AEM90-AX0903-D20-C20-L200-Z02	●	20	2	20	200	30	8.8			
AEM90-AX0903-D21-C20-L120-Z03	●	21	3	20	120	25	8.8			
AEM90-AX0903-D21-C20-L200-Z02	●	21	2	20	200	25	8.8			
AEM90-AX0903-D25-C25-L150-Z03	●	25	3	25	150	30	8.8			
AEM90-AX0903-D25-C25-L250-Z02	●	25	2	25	250	40	8.8			
AEM90-AX0903-D26-C25-L150-Z03	●	26	3	25	150	30	8.8			

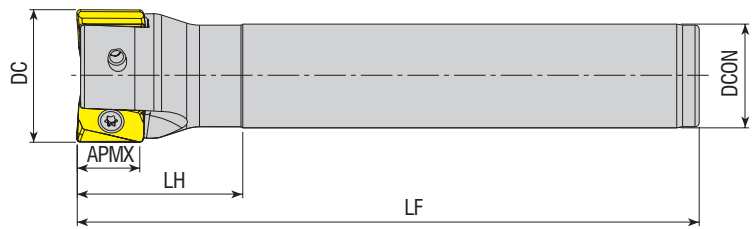

Takım Kodu Ordering Code Bestell-Bezeichnung	Stok Stock Lager	Takım Ölçüleri (mm) Dimension (mm) Abmessung (mm)						Kesici Uç Insert Wendeschneidplatte	Yedek Parçaları / Spare Parts / Ersatzteile	
		DC	ZEFP	DCON	LF	LH	APMX		Sıkma Vidası Screw Schraube	Tork Anahtar Torx Key Torx-Schlüssel
AEM90-AN1607-D32-C25-L150-Z02	●	32	2	25	150	50	15	AN.X 1607..	4015-M4x11	80-T15
AEM90-AN1607-D40-C32-L150-Z03	●	40	3	32	150	50	15			

R: Sağ / Right / Rechts/ L: Sol / Left / Links

● Stokta / In Stock / Auf Lager ○ Stokta Yok / Non Stock Item / Kein Lagerartikel, Lieferzeit auf Anfrage

TGTC Ucuna Uygundur. / Compatible with TGTC Insert. / Kompatibel mit TGTC Wendeplatten.

Sipariş Örneği/Ordering Example/Bestellbeispiel

1 ad./pcs./stück AEM90-AX0602-D10-C09-L120-Z02

Kesme Hesabı : S 429 / Cutting Calculation : P 429 / Schnittberechnung : P 429

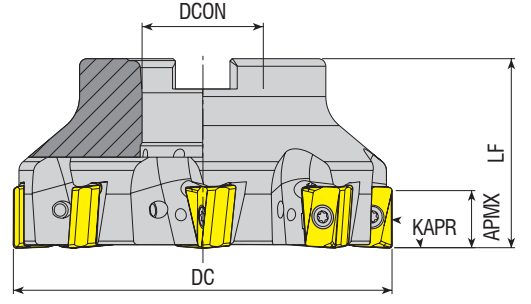

Takım Kodu Ordering Code Bestell-Bezeichnung	Stok Stock Lager	Takım Ölçüleri (mm) Dimension (mm) Abmessung (mm)					Kesici Uç Insert Wendeschneidplatte	Yedek Parçaları / Spare Parts / Ersatzteile			
		DC	ZEFP	DCON	LF	APMX		Sıkma Vidası Screw Schraube	Tork Anahtar Torx Key Torx-Schlüssel	Montaj Vidası Mounting Screw Befestigungsschraube	
AFM90-AN1607-D050-A22-Z04-H	●	50	4	22	40	15	AN.X 1607..		80-T15		
AFM90-AN1607-D063-A22-Z06-H	●	63	6	22	40	15					2508-M10x30
AFM90-AN1607-D080-A27-Z07-H	●	80	7	27	50	15					2510-M12x35
AFM90-AN1607-D100-A32-Z08-H	●	100	8	32	50	15					2514-M16x35
AFM90-AN1607-D125-B40-Z10	●	125	10	40	63	15					-

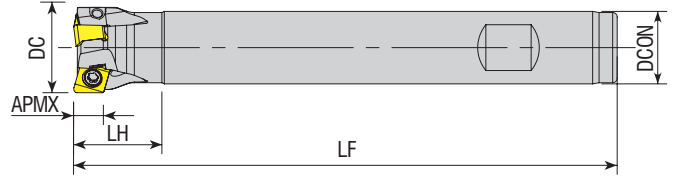

Takım Kodu Ordering Code Bestell-Bezeichnung	Stok Stock Lager	Takım Ölçüleri (mm) Dimension (mm) Abmessung (mm)						Kesici Uç Insert Wendeschneidplatte	Yedek Parçaları / Spare Parts / Ersatzteile				
		DC	ZEFP	DCON	LF	LH	APMX		Sıkma Vidası Screw Schraube	Tork Anahtar Torx Key Torx-Schlüssel			
AEM90-4N06-D16-W16-L120-Z02-H	●	16	2	16	120	25	6						
AEM90-4N06-D16-W16-L160-Z02	●	16	2	16	160	25	6						
AEM90-4N06-D20-W16-L120-Z03-H	●	20	3	16	120	20	6				4NKT 0603..	1108-M3x6.8	82-T08
AEM90-4N06-D20-W16-L160-Z03	●	20	3	16	160	20	6						
AEM90-4N06-D20-W20-L160-Z03	●	20	3	20	160	25	6						
new AEM90-490R14-D40-W32-L150-Z03	●	40	3	32	150	40	10	490R-1404..	4015-M3.5x11	80-T15			

R: Sağ / Right / Rechts/ L: Sol / Left / Links

● Stokta / In Stock / Auf Lager ○ Stokta Yok / Non Stock Item / Kein Lagerartikel, Lieferzeit auf Anfrage

TGTC Ucuna Uygundur. / Compatible with TGTC Insert. / Kompatibel mit TGTC Wendeplatten.

Sipariş Örneği/Ordering Example/Bestellbeispiel

1 ad./pcs./stück AFM90-AN1607-D050-A22-Z04-H

Kesme Hesabı : S 429 / Cutting Calculation : P 429 / Schnittberechnung : P 429

Sıkma Tork Değeri : S 428 / Tightening Torque : P 428 / Anzugsmoment : P 428



TGTC Ucuna Uygunudur. / Compatible with TGTC Insert. / Kompatibel mit TGTC Wendeplatten.



KAPR=90°

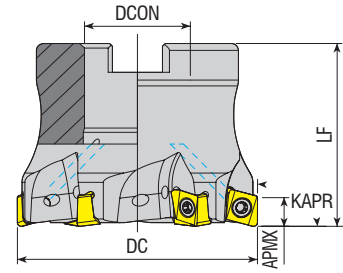

Takım Kodu Ordering Code Bestell-Bezeichnung	Stok Stock Lager	Takım Ölçüleri (mm) Dimension (mm) Abmessung (mm)					Kesici Uç Insert Wendeschneidplatte	Yedek Parçaları / Spare Parts / Ersatzteile		
		DC	ZEFP	DCON	LF	APMX		Sıkma Vidası Screw Schraube	Tork Anahtar Torx Key Torx-Schlüssel	Montaj Vidası Mounting Screw Befestigungsschraube
AFM90-4N06-D040-A16-Z05-H	●	40	5	16	40	6	4NKT 0603..	1108-M3x6.8	82-T08	2506-M8x30
AFM90-4N06-D050-A22-Z06-H	●	50	6	22	40	6				2508-M10x30

KAPR=90°

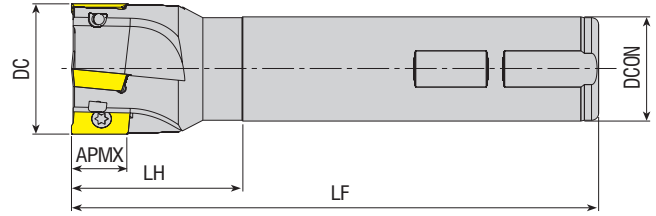

Takım Kodu Ordering Code Bestell-Bezeichnung	Stok Stock Lager	Takım Ölçüleri (mm) Dimension (mm) Abmessung (mm)						Kesici Uç Insert Wendeschneidplatte	Yedek Parçaları / Spare Parts / Ersatzteile	
		DC	ZEFP	DCON	LF	LH	APMX		Sıkma Vidası Screw Schraube	Tork Anahtar Torx Key Torx-Schlüssel
AEM90-AP09-D16-C16-L100-Z02-H	●	16	2	16	100	30	8.8	APKT 09T3..	3008-M2.5x5	82-T08
AEM90-AP09-D16-C15-L150-Z02	●	16	2	15	150	25	8.8			
AEM90-AP09-D16-W16-L150-Z02-H	●	16	2	16	150	25	8.8			
AEM90-AP09-D16-C16-L200-Z02-H	●	16	2	16	200	100	8.8			
AEM90-AP09-D17-C16-L150-Z02	●	17	2	16	150	25	8.8			
AEM90-AP09-D17-C16-L180-Z02-H	●	17	2	16	180	25	8.8			
AEM90-AP09-D20-C20-L150-Z03-H	●	20	3	20	150	50	8.8			
AEM90-AP09-D20-C20-L200-Z03-H	●	20	3	20	200	100	8.8			
AEM90-AP09-D20-C20-L250-Z02-H	●	20	2	20	250	150	8.8			
AEM90-AP09-D21-C20-L150-Z03	●	21	3	20	150	25	8.8			
AEM90-AP09-D21-C20-L180-Z02-H	●	21	2	20	180	25	8.8	3008-M2.5x6		
AEM90-AP09-D26-C25-L150-Z04	●	26	4	25	150	30	8.8			
AEM90-AP1204-D20-C20-L150-Z02	●	20	2	20	150	30	12	AP. 1204..	3010-M3.5x7	82-T10
AEM90-AP1204-D21-C20-L150-Z02	●	21	2	20	150	30	12			
AEM90-AP1204-D21-C20-L200-Z02	●	21	2	20	200	30	12			
AEM90-AP1204-D22-C20-L200-Z02	●	22	2	20	200	30	12			
AEM90-AP1204-D25-C25-L150-Z03	●	25	3	25	150	40	12			
AEM90-AP1204-D25-C25-L250-Z03	●	25	3	25	250	40	12			
AEM90-AP1204-D26-C25-L250-Z02	●	26	2	25	250	35	12			
AEM90-AP1204-D32-C25-L150-Z03	●	32	3	25	150	35	12	AP. 1705..	4015-M4x9	
AEM90-AP1705-D25-C25-L120-Z02	●	25	2	25	120	40	16			
AEM90-AP1705-D26-C25-L200-Z02	●	26	2	25	200	40	16			
AEM90-AP1705-D26-C25-L250-Z02	●	26	2	25	250	40	16			
AEM90-AP1705-D26-C25-L300-Z02	●	26	2	25	300	40	16			
AEM90-AP1705-D28-W25-L075-Z02	●	28	2	25	75	20	16			
AEM90-AP1705-D32-C25-L150-Z03	●	32	3	25	150	40	16			
AEM90-AP1705-D33-C32-L250-Z03	●	33	3	32	250	40	16			
AEM90-AP1705-D33-C32-L300-Z02	●	33	2	32	300	40	16			

R: Sağ / Right / Rechts/ L: Sol / Left / Links

● Stokta / In Stock / Auf Lager ○ Stokta Yok / Non Stock Item / Kein Lagerartikel, Lieferzeit auf Anfrage

Kesme Hesabı : S 429 / Cutting Calculation : P 429 / Schnittberechnung : P 429

TGTC Ucuna Uygunudur. / Compatible with TGTC Insert. / Kompatibel mit TGTC Wendeplatten.

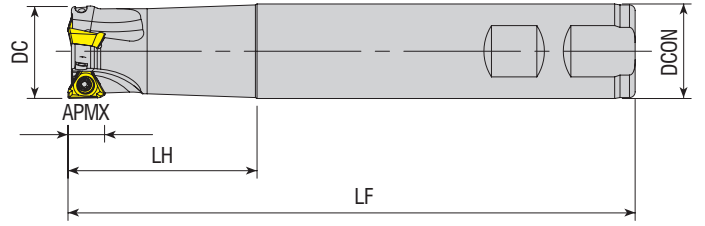

Takım Kodu Ordering Code Bestell-Bezeichnung	Stok Stock Lager	Takım Ölçüleri (mm) Dimension (mm) Abmessung (mm)						Kesici Uç Insert Wendescheidplatte	Yedek Parçaları / Spare Parts / Ersatzteile	
		DC	ZEFP	DCON	LF	LH	APMX		Sıkma Vidası Screw Schraube	Tork Anahtar Torx Key Torx-Schlüssel
AEM90-3P0603-D12-C12-L120-Z01-H	●	12	1	12	120	25	4.7	3PKT 0603	3006-M2x4	82-T06
AEM90-3P0603-D16-W16-L120-Z03-H	●	16	3	16	120	25	4.7			
AEM90-3P0603-D20-W20-L150-Z03-H	●	20	3	20	150	25	4.7			
AEM90-3P0603-D25-W25-L150-Z05-H	●	25	5	25	150	25	4.7			
AEM90-3P1004-D20-W20-L150-Z02	●	20	2	20	150	70	7	3PKT 1004	1108-M2.5x6	82-T08
AEM90-3P1004-D21-C20-L200-Z02	●	21	2	20	200	30	7			
AEM90-3P1004-D22-W20-L150-Z02	●	22	2	20	150	30	7			
AEM90-3P1004-D25-W25-L150-Z03	●	25	3	25	150	40	7			
new AEM90-3P1004-D26-C25-L200-Z02	○	26	2	25	200	30	7			
new AEM90-3P1004-D26-C25-L250-Z02	●	26	2	25	250	30	7			
new AEM90-3P1004-D33-C32-L200-Z03	●	33	3	32	200	30	7	3PKT 1505	1115-M4x10	80-T15
new AEM90-3P1004-D33-C32-L250-Z03	●	33	3	32	250	30	7			
AEM90-3P1505-D32-W32-L150-Z03	●	32	3	32	150	50	11			
AEM90-3P1505-D38-W32-L150-Z03	●	38	3	32	150	35	11			
AEM90-3P1505-D40-W32-L150-Z04	●	40	4	32	150	35	11			

R: Sağ / Right / Rechts/ L: Sol / Left / Links

● Stokta / In Stock / Auf Lager ○ Stokta Yok / Non Stock Item / Kein Lagerartikel, Lieferzeit auf Anfrage

TGTC Ucuna Uygundur. / Compatible with TGTC Insert. / Kompatibel mit TGTC Wendeplatten.

Sipariş Örneği/Ordering Example/Bestellbeispiel

1 ad./pcs./stück AEM90-3P0603-D12-C12-L120-Z01-H

Kesme Hesabı : S 429 / Cutting Calculation : P 429 / Schnittberechnung : P 429



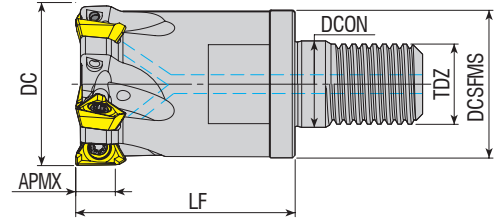

Takım Kodu Ordering Code Bestell-Bezeichnung	Stok Stock Lager	Takım Ölçüleri (mm) Dimension (mm) Abmessung (mm)							Kesici Uç Insert Wendeschneidplatte	Yedek Parçaları / Spare Parts / Ersatzteile		
		DC	ZEFP	DCSFMS	TDZ	LF	DCON	APMX		Sıkma Vidası Screw Schraube	Tork Anahtar Torx Key Torx-Schlüssel	
AEM90-3P1004-D20-M10-L35-Z02	●	20	2	18	M10	35	10.5	7				
AEM90-3P1004-D32-M16-L43-Z05-H	●	32	5	29	M16	43	17	7	3PT 1004	1108-M2.5x6	82-T08	

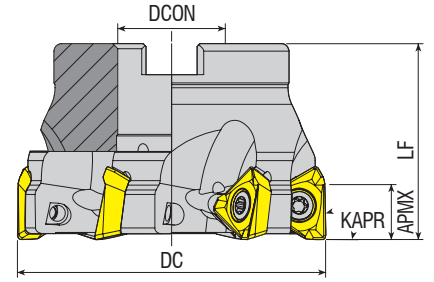

Takım Kodu Ordering Code Bestell-Bezeichnung	Stok Stock Lager	Takım Ölçüleri (mm) Dimension (mm) Abmessung (mm)					Kesici Uç Insert Wendeschneidplatte	Yedek Parçaları / Spare Parts / Ersatzteile			
		DC	ZEFP	DCON	LF	APMX		Sıkma Vidası Screw Schraube	Tork Anahtar Torx Key Torx-Schlüssel	Montaj Vidası Mounting Screw Befestigungsschraube	
AFM90-3P1004-D040-A16-Z05-H	●	40	5	16	40	7	3PKT 1004..	1108-M2.5x6	82-T08	2506-M8x30	
AFM90-3P1004-D050-A22-Z06-H	●	50	6	22	40	7					
AFM90-3P1505-D050-A22-Z04-H	●	50	4	22	40	11	3PKT 1505..	1115-M4x10	80-T15	2508-M10x30	
AFM90-3P1505-D050-A22-Z05-H	●	50	5	22	40	11					
AFM90-3P1505-D063-A22-Z04-H	●	63	4	22	40	11					
AFM90-3P1505-D063-A22-Z06-H	●	63	6	22	40	11					
AFM90-3P1505-D080-A27-Z07-H	●	80	7	27	50	11					
AFM90-3P1505-D100-A32-Z08-H	●	100	8	32	50	11					
AFM90-3P1505-D125-B40-Z10	●	125	10	40	63	11					
AFM90-3P1906-D080-A27-Z07-H	●	80	7	27	50	15	3PKT 1906..	1120-M4.5x12	80-T20	2514-M16x35	
AFM90-3P1906-D100-A32-Z08-H	●	100	8	32	50	15					
AFM90-3P1906-D125-B40-Z10	●	125	10	40	63	15					

R: Sağ / Right / Rechts! L: Sol / Left / Links
● Stokta / In Stock / Auf Lager ○ Stokta Yok / Non Stock Item / Kein Lagerartikel, Lieferzeit auf Anfrage
TGTC Ucuna Uygun. / Compatible with TGTC Insert. / Kompatibel mit TGTC Wendeplatten.

Sipariş Örneği/Ordering Example/Bestellbeispiel
1 ad./pcs./stück AEM90-3P1004-D20-M10-L35-Z02
Kesme Hesabı : S 429 / Cutting Calculation : P 429 / Schnittberechnung : P 429

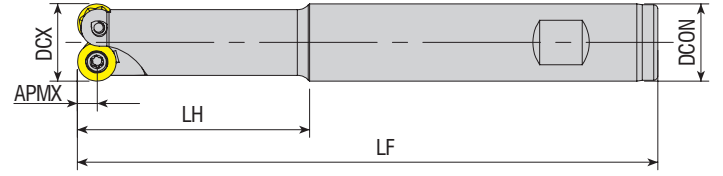

Takım Kodu Ordering Code Bestell-Bezeichnung	Stok Stock Lager	Takım Ölçüleri (mm) Dimension (mm) Abmessung (mm)						Kesici Uç Insert Wendeschneidplatte	Yedek Parçaları / Spare Parts / Ersatzteile		
		DCX	ZEFP	DCON	LF	LH	APMX		Sıkma Vidası Screw Schraube	Tork Anahtar Torx Key Torx-Schlüssel	
AEMR-RY08-D16-W16-L150-Z02	●	16	2	16	150	55	4	RVMX 0803..	4010-M3x6	82-T10	
AEMR-RY10-D20-W20-L150-Z02	●	20	2	20	150	60	5				
AEMR-RY10-D20-C20-L200-Z02	●	20	2	20	200	100	5				
AEMR-RY10-D21-W20-L200-Z02-H	●	21	2	20	200	30	5				
AEMR-RY10-D25-W25-L150-Z02	●	25	2	25	150	60	5	RVMX 1004..	4015-M3.5x8	80-T15	
AEMR-RY10-D26-W25-L200-Z02-H	●	26	2	25	200	60	5				
AEMR-RY10-D32-W32-L160-Z04-H	●	32	4	32	160	60	5				
AEMR-RY12-D32-C25-L160-Z03	●	32	3	25	160	30	6	RVMX 1205..	4015-M4x11		

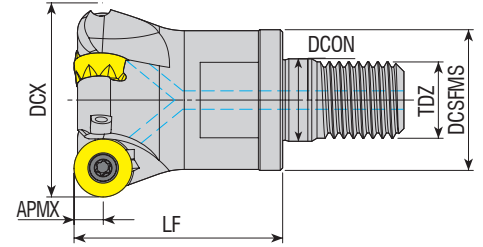

Takım Kodu Ordering Code Bestell-Bezeichnung	Stok Stock Lager	Takım Ölçüleri (mm) Dimension (mm) Abmessung (mm)							Kesici Uç Insert Wendeschneidplatte	Yedek Parçaları / Spare Parts / Ersatzteile		
		DCX	ZEFP	DCSFMS	TDZ	LF	DCON	APMX		Sıkma Vidası Screw Schraube	Tork Anahtar Torx Key Torx-Schlüssel	
AEMR-RY10-D25-M12-L43-Z03-H	●	25	3	21	M12	43	12.5	5	RVMX 1004..	4015-M3.5x9	80-T15	
AEMR-RY10-D32-M16-L43-Z04-H	●	32	4	29	M16	43	17	5				
AEMR-RY10-D40-M16-L43-Z05-H	●	40	5	29	M16	43	17	5				
AEMR-RY12-D32-M16-L43-Z03-H	●	32	3	29	M16	43	17	6	RVMX 1205..	4015-M4x9		
AEMR-RY12-D40-M16-L43-Z03-H	●	40	3	29	M16	43	17	6				

R: Sağ / Right / Rechts/ L: Sol / Left / Links

● Stokta / In Stock / Auf Lager ○ Stokta Yok / Non Stock Item / Kein Lagerartikel, Lieferzeit auf Anfrage

TGTC Ucuna Uygundur. / Compatible with TGTC Insert. / Kompatibel mit TGTC Wendeplatten.

Sipariş Örneği/Ordering Example/Bestellbeispiel

1 ad./pcs./stück AEMR-RY08-D16-W16-L150-Z02

Kesme Hesabı : S 429 / Cutting Calculation : P 429 / Schnittberechnung : P 429

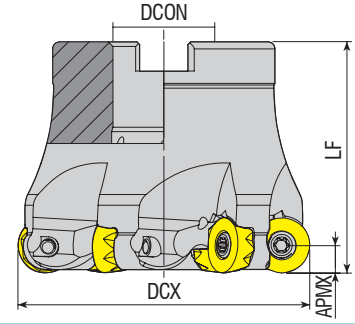

Takım Kodu Ordering Code Bestell-Bezeichnung	Stok Stock Lager	Takım Ölçüleri (mm) Dimension (mm) Abmessung (mm)					Kesici Uç Insert Wendeschneidplatte	Yedek Parçaları / Spare Parts / Ersatzteile		
		DCX	ZEFP	DCON	LF	APMX		Sıkma Vidası Screw Schraube	Tork Anahtar Torx Key Torx-Schlüssel	Montaj Vidası Mounting Screw Befestigungsschraube
AFMR-RY10-D040-A16-Z04-H	●	40	4	16	40	5	RYMX 1004..	4015-M3.5x11	80-T15	2406-M8x30
AFMR-RY10-D040-A16-Z05-H	●	40	5	16	40	5				2506-M8x30
AFMR-RY10-D050-A22-Z05-H	●	50	5	22	50	5				2508-M10x30
AFMR-RY10-D063-A22-Z06-H	●	63	6	22	50	5				
AFMR-RY12-D040-A16-Z04-H	●	40	4	16	40	6	RYMX 1205..	4015-M4x11	80-T15	2406-M8x30
AFMR-RY12-D050-A22-Z05-H	●	50	5	22	50	6				2508-M10x30
AFMR-RY12-D052-A22-Z05-H	●	52	5	22	50	6				
AFMR-RY12-D063-A22-Z06-H	●	63	6	22	50	6				
AFMR-RY12-D080-A27-Z06-H	●	80	6	27	50	6				
AFMR-RY12-D100-A32-Z07-H	●	100	7	32	50	6				

R: Sağ / Right / Rechts/ L: Sol / Left / Links

● Stokta / In Stock / Auf Lager ○ Stokta Yok / Non Stock Item / Kein Lagerartikel, Lieferzeit auf Anfrage

TGTC Ucuna Uygundur. / Compatible with TGTC Insert. / Kompatibel mit TGTC Wendeplatten.

Sipariş Örneği/Ordering Example/Bestellbeispiel

1 ad./pcs./stück AFMR-RY10-D040-A16-Z04-H

Kesme Hesabı : S 429 / Cutting Calculation : P 429 / Schnittberechnung : P 429



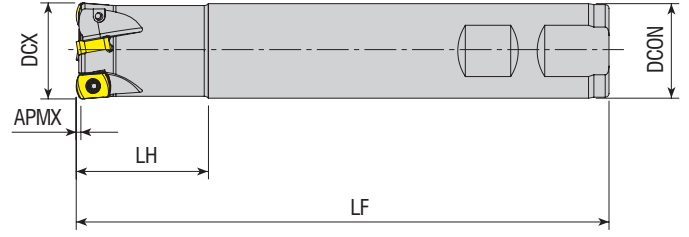

Takım Kodu Ordering Code Bestell-Bezeichnung	Stok Stock Lager	Takım Ölçüleri (mm) Dimension (mm) Abmessung (mm)						Kesici Uç Insert Wendeschneidplatte	Yedek Parçaları / Spare Parts / Ersatzteile	
		DCX	ZEFP	DCON	LF	LH	APMX		Sıkma Vidası Screw Schraube	Tork Anahtar Torx Key Torx-Schlüssel
AHFM-BL0603-D16-C15-L150-Z02	●	16	2	15	150	20	1	BLMP 0603..	3008-M2.5x6	82-T08
AHFM-BL0603-D16-C16-L100-Z02-H	●	16	2	16	100	30	1			
AHFM-BL0603-D16-C16-L150-Z02	●	16	2	16	150	50	1			
AHFM-BL0603-D17-C16-L150-Z02	●	17	2	16	150	20	1			
AHFM-BL0603-D17-W16-L170-Z02	●	17	2	16	170	20	1			
AHFM-BL0603-D17-W16-L170-Z02-H	●	17	2	16	170	20	1			
AHFM-BL0603-D17-C16-L200-Z02	●	17	2	16	200	20	1			
AHFM-BL0603-D18-C16-L150-Z02	●	18	2	16	150	20	1			
AHFM-BL0603-D18-W16-L150-Z02-H	●	18	2	16	150	20	1			
AHFM-BL0603-D20-C20-L130-Z03	●	20	3	20	130	50	1			
AHFM-BL0603-D20-C20-L160-Z03	●	20	3	20	160	50	1			
AHFM-BL0603-D21-C20-L200-Z03	●	21	3	20	200	25	1			
AHFM-BL0603-D21-W20-L200-Z03	●	21	3	20	200	25	1			
AHFM-BL0603-D22-W20-L150-Z03	●	22	3	20	150	20	1			
AHFM-BL0603-D25-C25-L250-Z04	●	25	4	25	250	40	1			
AHFM-BL0603-D26-C25-L150-Z04	●	26	4	25	150	35	1			
AHFM-BL0603-D26-C25-L200-Z04	●	26	4	25	200	35	1			
AHFM-BL0603-D26-W25-L200-Z04	●	26	4	25	200	35	1			
AHFM-BL0603-D26-C25-L250-Z04	●	26	4	25	250	35	1			
new AHFM-BL0603-D30-C25-L150-Z05	●	30	5	25	150	40	1			
AHFM-BL0603-D32-C32-L150-Z05	●	32	5	32	150	70	1			
AHFM-BL0603-D32-C32-L200-Z05	●	32	5	32	200	120	1			
AHFM-BL0603-D33-C32-L150-Z05	●	33	5	32	150	40	1			
AHFM-BL0603-D33-C32-L200-Z05	●	33	5	32	200	40	1			
AHFM-BL0603-D33-C32-L250-Z05	●	33	5	32	250	40	1			
AHFM-BL0904-D28-W25-L180-Z03	●	28	3	25	180	30	1.5	BLMP 0904..	3010-M3.5x9	82-T10

R: Sağ / Right / Rechts/ L: Sol / Left / Links
● Stokta / In Stock / Auf Lager ○ Stokta Yok / Non Stock Item / Kein Lagerartikel, Lieferzeit auf Anfrage
TGTC Ucuna Uygundur. / Compatible with TGTC Insert. / Kompatibel mit TGTC Wendeplatten.

Sipariş Örneği/Ordering Example/Bestellbeispiel
1 ad./pcs./stück AHFM-BL0603-D16-C15-L150-Z02
Kesme Hesabı : S 429 / Cutting Calculation : P 429 / Schnittberechnung : P 429

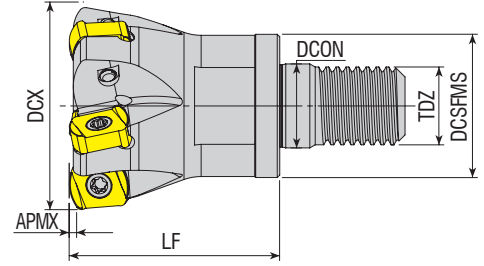

Takım Kodu Ordering Code Bestell-Bezeichnung	Stok Stock Lager	Takım Ölçüleri (mm) Dimension (mm) Abmessung (mm)							Kesici Uç Insert Wendeschneidplatte	Yedek Parçaları / Spare Parts / Ersatzteile		
		DCX	ZEFP	DCSFMS	TDZ	LF	DCON	APMX		Sıkma Vidası Screw Schraube	Tork Anahtar Torx Key Torx-Schlüssel	
new AHFM-BL0603-D17-M08-L35-Z02-H	●	17	2	16	M08	35	8.5	1	BLMP 0603..		3008-M2.5x6	82-T08
AHFM-BL0603-D20-M10-L30-Z03-H	●	20	3	18	M10	30	10.5	1				
new AHFM-BL0603-D21-M10-L35-Z03-H	●	21	3	19	M10	35	10.5	1				
AHFM-BL0603-D25-M12-L35-Z04-H	●	25	4	21	M12	35	12.5	1				
AHFM-BL0603-D32-M16-L40-Z05-H	●	32	5	29	M16	40	17	1				
AHFM-BL0904-D32-M16-L40-Z04-H	●	32	4	29	M16	40	17	1.5	BLMP 0904..		3010-M3.5x9	82-T10
AHFM-BL0904-D32-M16-L43-Z04-H	●	32	4	29	M16	43	17	1.5				
AHFM-BL0904-D42-M16-L43-Z05-H	●	42	5	29	M16	43	17	1.5				

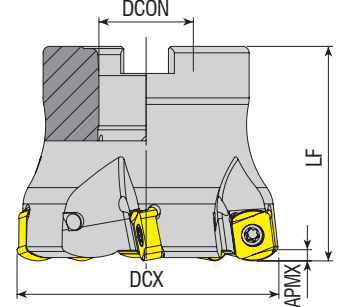

Takım Kodu Ordering Code Bestell-Bezeichnung	Stok Stock Lager	Takım Ölçüleri (mm) Dimension (mm) Abmessung (mm)					Kesici Uç Insert Wendeschneidplatte	Yedek Parçaları / Spare Parts / Ersatzteile						
		DCX	ZEFP	DCON	LF	APMX		Sıkma Vidası Screw Schraube	Tork Anahtar Torx Key Torx-Schlüssel	Montaj Vidası Mounting Screw Befestigungsschraube				
AHFM-BL0603-D040-A16-Z06-H	●	40	6	16	40	1	BLMP 0603..			82-T08	2506-M8x30			
AHFM-BL0603-D050-A22-Z07-H	●	50	7	22	50	1								
AHFM-BL0904-D040-A16-Z05-H	●	40	5	16	40	2								
AHFM-BL0904-D050-A22-Z06-H	●	50	6	22	50	2					BLMP 0904..	3010-M3.5x9	82-T10	2508-M10x30
AHFM-BL0904-D063-A22-Z05-H	●	63	5	22	50	2								
AHFM-BL0904-D063-A22-Z07-H	●	63	7	22	50	2								

R: Sağ / Right / Rechts/ L: Sol / Left / Links

● Stokta / In Stock / Auf Lager ○ Stokta Yok / Non Stock Item / Kein Lagerartikel, Lieferzeit auf Anfrage

TGTC Ucuna Uygun. / Compatible with TGTC Insert. / Kompatibel mit TGTC Wendeplatten.

Sipariş Örneği/Ordering Example/Bestellbeispiel

1 ad./pcs./stück AHFM-BL0603-D17-M08-L35-Z02-H

Kesme Hesabı : S 429 / Cutting Calculation : P 429 / Schnittberechnung : P 429

Sıkma Tork Değeri : S 428 / Tightening Torque : P 428 / Anzugsmoment : P 428

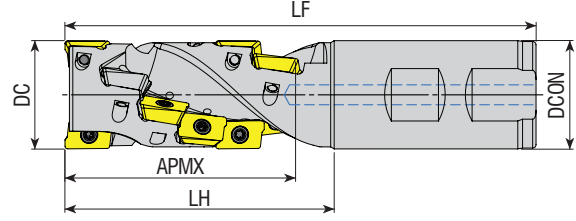
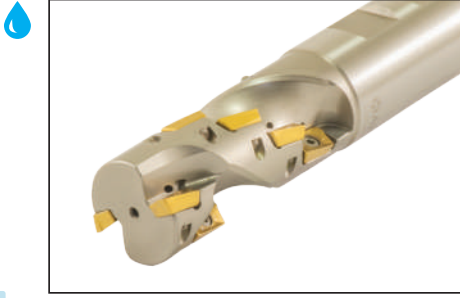

Takım Kodu Ordering Code Bestell-Bezeichnung	Stok Stock Lager	Takım Ölçüleri (mm) Dimension (mm) Abmessung (mm)							Kesici Uç Insert Wendeschneidplatte	Yedek Parçaları / Spare Parts / Ersatzteile		
		ZEFP		DC	DCON	APMX	LH	LF		Sıkma Vidası Screw Schraube	Tork Anahtar Torx Key Torx-Schlüssel	
		Toplam Total Gesamt	Etkili Effective Effektiv									
AHM90-AP1204-D32-W32-L140-Z0212-H	●	12	2	32	32	68	80	140	AP. 1204..	3010-M3.5x9	82-T10	
AHM90-AP1204-D40-W32-L160-Z0321-H	●	21	3	40	32	79	100	160				

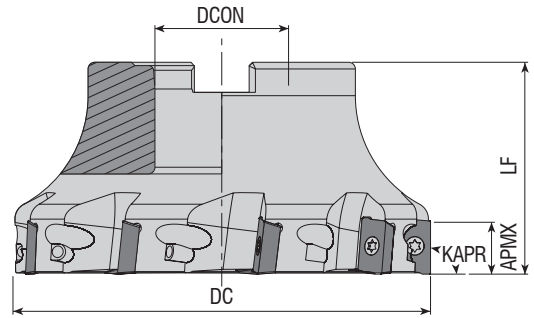

Takım Kodu Ordering Code Bestell-Bezeichnung	Stok Stock Lager	Takım Ölçüleri (mm) Dimension (mm) Abmessung (mm)					Kesici Uç Insert Wendeschneidplatte	Yedek Parçaları / Spare Parts / Ersatzteile			
		DC	ZEFP	DCON	LF	APMX		Sıkma Vidası Screw Schraube	Tork Anahtar Torx Key Torx-Schlüssel	Montaj Vidası Mounting Screw Befestigungsschraube	
AFM90-AP1705-D050-A22-Z05-H	●	50	5	22	40	16	AP. 1705..	4015-M4x11	80-T15	2508-M10x30	
AFM90-AP1705-D063-A22-Z06-H	●	63	6	22	40	16					
AFM90-AP1705-D080-A27-Z07-H	●	80	7	27	50	16					
AFM90-AP1705-D100-A32-Z08-H	●	100	8	32	50	16					

R: Sağ / Right / Rechts L: Sol / Left / Links

● Stokta / In Stock / Auf Lager ○ Stokta Yok / Non Stock Item / Kein Lagerartikel, Lieferzeit auf Anfrage

TGTC Ucuna Uyundur. / Compatible with TGTC Insert. / Kompatibel mit TGTC Wendeplatten.

Sipariş Örneği/Ordering Example/Bestellbeispiel

1 ad./pcs./stück AHM90-AP1204-D32-W32-L140-Z0212-H

Kesme Hesabı : S 429 / Cutting Calculation : P 429 / Schnittberechnung : P 429

Montaj Ölçüleri : S 426 / Mounting Reference : P 426 / Montagehinweis : P 426

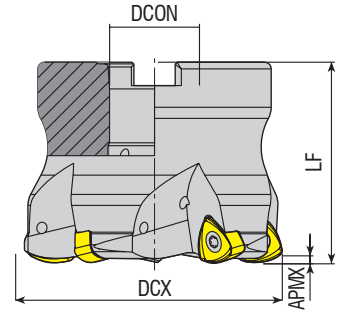

Takım Kodu Ordering Code Bestell-Bezeichnung	Stok Stock Lager	Takım Ölçüleri (mm) Dimension (mm) Abmessung (mm)					Kesici Uç Insert Wendescheidplatte	Yedek Parçaları / Spare Parts / Ersatzteile		
		DCX	ZEFP	DCON	LF	APMX		Sıkma Vidası Screw Schraube	Tork Anahtar Torx Key Torx-Schlüssel	Montaj Vidası Mounting Screw Befestigungsschraube
AHFM-BL1205-D050-A22-Z03-H	●	50	3	22	40	2	BLMP 1205..	4015-M4x11	80-T15	2508-M10x30
AHFM-BL1205-D063-A22-Z04-H	●	63	4	22	50	2				
AHFM-BL1205-D080-A27-Z05-H	●	80	5	27	60	2				2510-M12x35

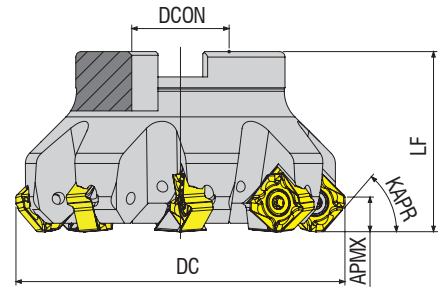

Takım Kodu Ordering Code Bestell-Bezeichnung	Stok Stock Lager	Takım Ölçüleri (mm) Dimension (mm) Abmessung (mm)					Kesici Uç Insert Wendescheidplatte	Yedek Parçaları / Spare Parts / Ersatzteile		
		DC	ZEFP	DCON	LF	APMX		Sıkma Vidası Screw Schraube	Tork Anahtar Torx Key Torx-Schlüssel	Montaj Vidası Mounting Screw Befestigungsschraube
AFM45-SN1306-D050-A22-Z05-H	●	50	5	22	40	7	SNGX 1306..	1115-M4x10	80-T15	2508-M10x30
AFM45-SN1306-D063-A22-Z06-H	●	63	6	22	40	7				2510-M12x35
AFM45-SN1306-D080-A27-Z07-H	●	80	7	27	50	7				2514-M16x35
AFM45-SN1306-D100-A32-Z08-H	●	100	8	32	50	7				

R: Sağ / Right / Rechts L: Sol / Left / Links

● Stokta / In Stock / Auf Lager ○ Stokta Yok / Non Stock Item / Kein Lagerartikel, Lieferzeit auf Anfrage

TGTC Ucuna Uygundur. / Compatible with TGTC Insert. / Kompatibel mit TGTC Wendeplatten.

Sipariş Örneği/Ordering Example/Bestellbeispiel

1 ad./pcs./stück AHFM-BL1205-D050-A22-Z03-H

Kesme Hesabı : S 429 / Cutting Calculation : P 429 / Schnittberechnung : P 429

Sıkma Tork Değeri : S 428 / Tightening Torque : P 428 / Anzugsmoment : P 428

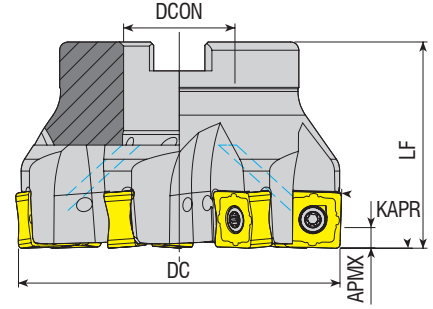

Takım Kodu Ordering Code Bestell-Bezeichnung	Stok Stock Lager	Takım Ölçüleri (mm) Dimension (mm) Abmessung (mm)					Kesici Uç Insert Wendeschneidplatte	Yedek Parçaları / Spare Parts / Ersatzteile		
		DC	ZEFP	DCON	LF	APMX		Sıkma Vidası Screw Schraube	Tork Anahtar Torx Key Torx-Schlüssel	Montaj Vidası Mounting Screw Befestigungsschraube
AFM88-SN1306-D050-A22-Z05-H	●	50	5	22	40	12	SNGX 1306..	1115-M4x10	80-T15	2508-M10x30
AFM88-SN1306-D063-A22-Z06-H	●	63	6	22	40	12				
AFM88-SN1306-D080-A27-Z07-H	●	80	7	27	50	12				

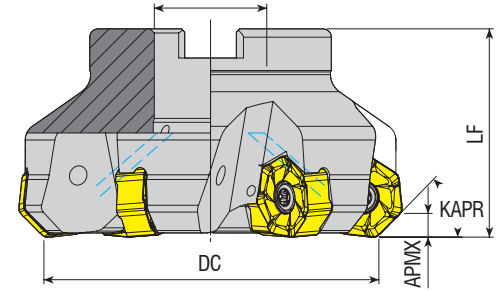

Takım Kodu Ordering Code Bestell-Bezeichnung	Stok Stock Lager	Takım Ölçüleri (mm) Dimension (mm) Abmessung (mm)					Kesici Uç Insert Wendeschneidplatte	Yedek Parçaları / Spare Parts / Ersatzteile				
		DC	ZEFP	DCON	LF	APMX		Sıkma Vidası Screw Schraube	Baskı Parçası Wedge Clamp Spannpratze	Baskı Vidası Clamp Screw Klemmschraube	Tork Anahtar Torx Key Torx-Schlüssel	Montaj Vidası Mounting Screw Befestigungsschraube
AFM45-XN0906-D063-A22-Z06-H	●	63	6	22	50	5	XNMU 0906..	1120-M5x13	-	-	80-T20	2407-M10x30
AFM45-XN0906-D080-A27-Z06-H	●	80	6	27	50	5						2510-M12x35
AFM45-XN0906-D100-A32-Z07-H	●	100	7	32	55	5						2514-M16x35
AFM45-XN0906-D125-B40-Z08	●	125	8	40	63	5						-

R: Sağ / Right / Rechts/ L: Sol / Left / Links

● Stokta / In Stock / Auf Lager ○ Stokta Yok / Non Stock Item / Kein Lagerartikel, Lieferzeit auf Anfrage

TGTC Ucuna Uygunudur. / Compatible with TGTC Insert. / Kompatibel mit TGTC Wendeplatten.

Sipariş Örneği/Ordering Example/Bestellbeispiel

1 ad./pcs./stück AFM88-SN1306-D050-A22-Z05-H

Kesme Hesabı : S 429 / Cutting Calculation : P 429 / Schnittberechnung : P 429

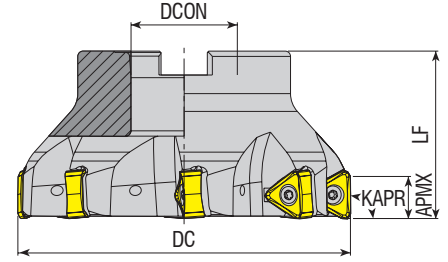

Takım Kodu Ordering Code Bestell-Bezeichnung	Stok Stock Lager	Takım Ölçüleri (mm) Dimension (mm) Abmessung (mm)					Kesici Uç Insert Wendeschneidplatte	Yedek Parçaları / Spare Parts / Ersatzteile		
		DC	ZEFP	DCON	LF	APMX		Sıkma Vidası Screw Schraube	Tork Anahtar Torx Key Torx-Schlüssel	Montaj Vidası Mounting Screw Befestigungsschraube
AFM90-TN2207-D063-A22-Z04-H	●	63	4	22	40	15	TN.X 2207..	1120-M4.5x12	80-T20	2508-M10x30
AFM90-TN2207-D080-A27-Z05-H	●	80	5	27	50	15				2510-M12x35
AFM90-TN2207-D100-B32-Z06	●	100	6	32	50	15				2514-M16x35
AFM90-TN2207-D125-B40-Z08	●	125	8	40	63	15				-

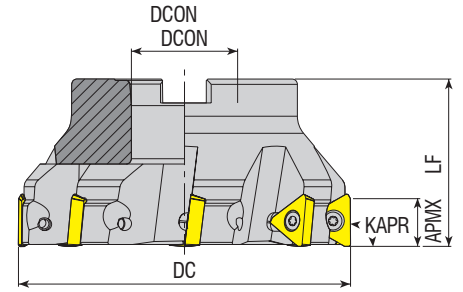

Takım Kodu Ordering Code Bestell-Bezeichnung	Stok Stock Lager	Takım Ölçüleri (mm) Dimension (mm) Abmessung (mm)					Kesici Uç Insert Wendeschneidplatte	Yedek Parçaları / Spare Parts / Ersatzteile		
		DC	ZEFP	DCON	LF	APMX		Sıkma Vidası Screw Schraube	Tork Anahtar Torx Key Torx-Schlüssel	Montaj Vidası Mounting Screw Befestigungsschraube
AFM90-TP2205-D063-A22-Z04	●	63	4	22	40	18	TPKT 2205..	1120-M4.5x12	80-T20	2508-M10x30
AFM90-TP2205-D080-A27-Z06	●	80	6	27	50	18				2510-M12x35
AFM90-TP2205-D100-A32-Z07	●	100	7	32	50	18				2514-M16x35
AFM90-TP2205-D125-B40-Z08	●	125	8	40	63	18				-
AFM90-TP2205-D160-C40-Z09	●	160	9	40	63	18				-
AFM90-TP2205-D200-C60-Z12	●	200	12	60	63	18				-

R: Sağ / Right / Rechts/ L: Sol / Left / Links
● Stokta / In Stock / Auf Lager ○ Stokta Yok / Non Stock Item / Kein Lagerartikel, Lieferzeit auf Anfrage
TGTC Ucuna Uygundur. / Compatible with TGTC Insert. / Kompatibel mit TGTC Wendeplatten.

Sipariş Örneği/Ordering Example/Bestellbeispiel
1 ad./pcs./stück AFM90-TN2207-D063-A22-Z04-H
Kesme Hesabı : S 429 / Cutting Calculation : P 429 / Schnittberechnung : P 429

TGTC Ucuna Uygunur. / Compatible with TGTC Insert. / Kompatibel mit TGTC Wendeplatten.

KAPR=90°

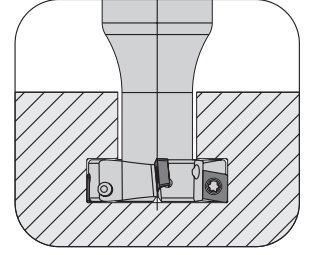
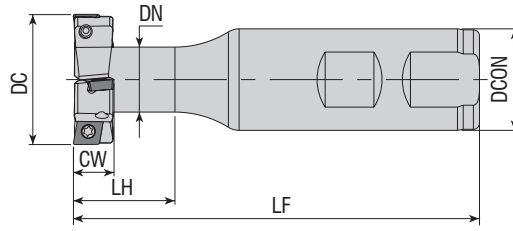

Takım Kodu Ordering Code Bestell-Bezeichnung	Stok Stock Lager	Takım Ölçüleri (mm) Dimension (mm) Abmessung (mm)							Kesici Uç Insert Wendeschneidplatte	Yedek Parçaları / Spare Parts / Ersatzteile		
		ZEFP		DC	CW	DCON	LF	DN		LH	Sıkma Vidası Screw Schraube	Tork Anahtar Torx Key Torx-Schlüssel
		Toplam Total Gesamt	Etkili Effective Effektiv									
ATSM90-SP.05-D22.5X5-W25-L100-Z04	●	4	2	22.5	5	25	100	12	25	SPMG 050204	3006-M2x4	82-T06
ATSM90-SP.05-D25X5-W25-L100-Z04	○	4	2	25	5	25	100	9	25			
ATSM90-SP.05-D30X5-W25-L100-Z04	●	4	2	30	5	25	100	10	25			
ATSM90-SP.06-D80X7-W32-L120-Z10	●	10	5	80	7	32	120	31.5	30			

TGTC Ucuna Uygunur. / Compatible with TGTC Insert. / Kompatibel mit TGTC Wendeplatten.

TNGLY Ucuna Uygunur. / Compatible with TNGLY Insert. / Kompatibel mit TNGLY Wendeplatten.

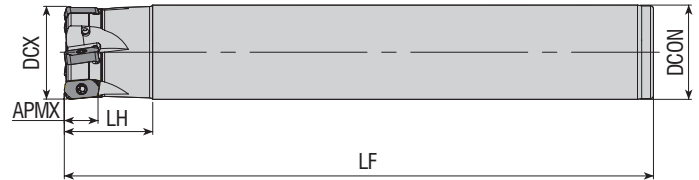

Takım Kodu Ordering Code Bestell-Bezeichnung	Stok Stock Lager	Takım Ölçüleri (mm) Dimension (mm) Abmessung (mm)						Kesici Uç Insert Wendeschneidplatte	Yedek Parçaları / Spare Parts / Ersatzteile	
		DCX	ZEFP	DCON	LF	LH	APMX		Sıkma Vidası Screw Schraube	Tork Anahtar Torx Key Torx-Schlüssel
AHFM-LN0303-D16-C15-L150-Z02	●	16	2	15	150	30	1	LNMU 0303..	3008-M2.5x6	82-T08
AHFM-LN0303-D16-W16-L150-Z02-H	●	16	2	16	150	50	1			
AHFM-LN0303-D17-C16-L150-Z02-H	●	17	2	16	150	30	1			
AHFM-LN0303-D20-W20-L150-Z03-H	●	20	3	20	150	50	1			
AHFM-LN0303-D21-C20-L150-Z03	●	21	3	20	150	30	1			
AHFM-LN0303-D25-W25-L150-Z04-H	●	25	4	25	150	50	1			
AHFM-LN0303-D26-C25-L150-Z04	●	26	4	25	150	30	1			
AHFM-LN0303-D28-C25-L180-Z03	●	28	3	25	180	30	1			
AHFM-LN0303-D33-C32-L200-Z05	●	33	5	32	200	30	1			

R: Sağ / Right / Rechts/ L: Sol / Left / Links

● Stokta / In Stock / Auf Lager ○ Stokta Yok / Non Stock Item / Kein Lagerartikel, Lieferzeit auf Anfrage

TNGLY Ucuna Uygunur. / Compatible with TNGLY Insert. / Kompatibel mit TNGLY Wendeplatten.

Sipariş Örneği/Ordering Example/ Bestellbeispiel

1 ad./pcs./stück ATSM90-SP.05-D22.5X5-W25-L100-Z04

Kesme Hesabı : S 429 / Cutting Calculation : P 429 / Schnittberechnung : P 429

Montaj Ölçüleri : S 426 / Mounting Reference : P 426 / Montagehinweis : P426

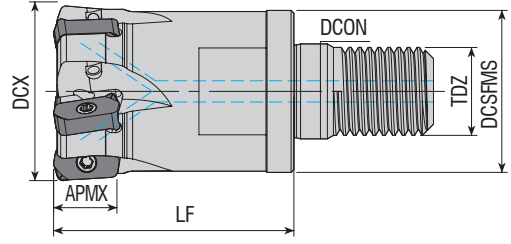

Takım Kodu Ordering Code Bestell-Bezeichnung	Stok Stock Lager	Takım Ölçüleri (mm) Dimension (mm) Abmessung (mm)							Kesici Uç Insert Wendeschneidplatte	Yedek Parçaları / Spare Parts / Ersatzteile				
		DCX	ZEP	DCSFMS	TDZ	LF	DCON	APMX		Sıkma Vidası Screw Schraube	Baskı Parçası Wedge Clamp Spannpratze	Baskı Vidası Clamp Screw Schraube	Tork Anahtar Torx Key Torx-Schlüssel	
AHFM-LN0303-D25-M12-L35-Z04-H	●	25	4	21	M12	35	12.5	12	LNMU 0303..	3008-M2.5x6	-	-	82-T08	
AHFM-LN0303-D32-M16-L43-Z05-H	●	32	5	29	M16	43	17	12						
AHFM-LN0303-D42-M16-L43-Z06-H	●	42	6	29	M16	43	17	12						

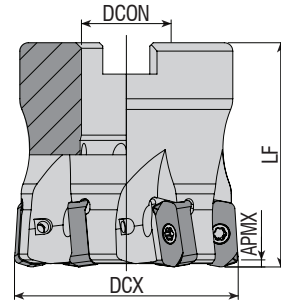

Takım Kodu Ordering Code Bestell-Bezeichnung	Stok Stock Lager	Takım Ölçüleri (mm) Dimension (mm) Abmessung (mm)					Kesici Uç Insert Wendeschneidplatte	Yedek Parçaları / Spare Parts / Ersatzteile			
		DCX	ZEP	DCON	LF	APMX		Sıkma Vidası Screw Schraube	Tork Anahtar Torx Key Torx-Schlüssel	Montaj Vidası Mounting Screw Befestigungsschraube	
AHFM-LN0303-D040-A16-Z06-H	●	40	6	16	40	12	LNMU 0303..	3008-M2.5X6	82-T08	2506-M8x30 2508-M10x30	
AHFM-LN0303-D050-A22-Z07-H	●	50	7	22	50	12					
AHFM-LN0303-D063-A22-Z09-H	●	63	9	22	50	12					

R: Sağ / Right / Rechts/ L: Sol / Left / Links

● Stokta / In Stock / Auf Lager ○ Stokta Yok / Non Stock Item / Kein Lagerartikel, Lieferzeit auf Anfrage

TNGLY Ucuna Uygun. / Compatible with TNGLY Insert. / Kompatibel mit TNGLY Wendeplatten.

Sipariş Örneği/Ordering Example/Bestellbeispiel

1 ad./pcs./stück AHFM-LN0303-D25-M12-L35-Z04-H

Kesme Hesabı : S 429 / Cutting Calculation : P 429 / Schnittberechnung : P 429

Sıkma Tork Değeri : S 428 / Tightening Torque : P 428 / Anzugsmoment : P 428

TNGLY Ucuna Uygundur. / Compatible with TNGLY Insert. / Kompatibel mit TNGLY Wendeplatten.



KAPR=90°

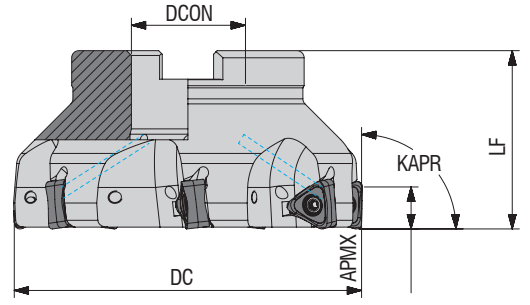

Takım Kodu Ordering Code Bestell-Bezeichnung	Stok Stock Lager	Takım Ölçüleri (mm) Dimension (mm) Abmessung (mm)					Kesici Uç Insert Wendeschneidplatte	Yedek Parçaları / Spare Parts / Ersatzteile			
		DC	ZEFP	DCON	LF	APMX		Sıkma Vidası Screw Schraube	Tork Anahtar Torx Key Torx-Schlüssel	Montaj Vidası Mounting Screw Befestigungsschraube	
AFM90-TN1207-D050-A22-Z04-H	●	50	4	22	40	11	TNMU 1207..	3010-M3.5X9	82-T10	2407-M10x30	
AFM90-TN1207-D063-A22-Z05-H	●	63	5	22	40	11					
AFM90-TN1207-D080-A27-Z06-H	●	80	6	27	50	11					
AFM90-TN1207-D100-A32-Z07-H	●	100	7	32	50	11					
AFM90-TN1207-D125-B40-Z08	●	125	8	40	63	11					

TNGLY Ucuna Uygundur. / Compatible with TNGLY Insert. / Kompatibel mit TNGLY Wendeplatten.

UNIN Ucuna Uygundur. / Compatible with UNIN Insert. / Kompatibel mit UNIN Wendeplatten.

KAPR=88°

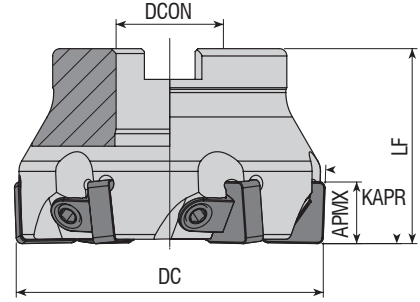

Takım Kodu Ordering Code Bestell-Bezeichnung	Stok Stock Lager	Takım Ölçüleri (mm) Dimension (mm) Abmessung (mm)					Kesici Uç Insert Wendeschneidplatte	Yedek Parçaları / Spare Parts / Ersatzteile			
		DC	ZEFP	DCON	LF	APMX		Baskı Parçası Wedge Clamp Spannpratze	Baskı Vidası Clamp Screw Klemmschraube	Anahtar Allen Key Innensechskantschlüssel	Montaj Vidası Mounting Screw Befestigungsschraube
AFM88C-SN1204-D050-A22-Z05	●	50	5	22	40	11	SN.. 1204..	ACK-21	AKV-24-M6x1x18	AAL-03-3	2408-M10x30
AFM88C-SN1204-D063-A22-Z06	●	63	6	22	40	11					
AFM88C-SN1204-D080-A27-Z07	●	80	7	27	50	11					
AFM88C-SN1204-D100-A32-Z08	●	100	8	32	50	11					
AFM88C-SN1204-D125-B40-Z11	●	125	11	40	63	11					

R: Sağ / Right / Rechts L: Sol / Left / Links

● Stokta / In Stock / Auf Lager ○ Stokta Yok / Non Stock Item / Kein Lagerartikel, Lieferzeit auf Anfrage

UNIN Ucuna Uygundur. / Compatible with UNIN Insert. / Kompatibel mit UNIN Wendeplatten.

Sipariş Örneği/Ordering Example/Bestellbeispiel

1 ad./pcs./stück AFM90-TN1207-D050-A22-Z04-H

Kesme Hesabı : S 429 / Cutting Calculation : P 429 / Schnittberechnung : P 429

Sıkma Tork Değeri : S 428 / Tightening Torque : P 428 / Anzugsmoment : P 428

VRGS Ucuna Uygunudur. / Compatible with VRGS Insert. / Kompatibel mit VRGS Wendeplatten.

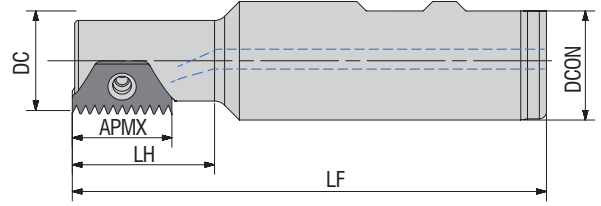

Takım Kodu Ordering Code Bestell-Bezeichnung	Stok Stock Lager	Takım Ölçüleri (mm) Dimension (mm) Abmessung (mm)						Kesici Uç Insert Wendeschneidplatte	Yedek Parçaları / Spare Parts / Ersatzteile		
		DC	ZEFP	DCON	LF	LH	APMX		Sıkma Vidası Screw Schraube	Tork Anahtar Torx Key Torx-Schlüssel	
ATM-3BEI-D21-W25-L100-Z01-H	●	21	1	25	100	30	21		1710-U5-40x8.8		
ATM-3EI-D14-W20-L90-Z01-H	●	14	1	20	90	22	15.3		1710-U5-40x7.2		82-T10
ATM-3EI-D20-W25-L120-Z01-H	●	20	1	25	120	25	15.3				

VRGS Ucuna Uygunudur. / Compatible with VRGS Insert. / Kompatibel mit VRGS Wendeplatten.

WDA Ucuna Uygunudur. / Compatible with WDA Insert. / Kompatibel mit WDA Wendeplatten.

new

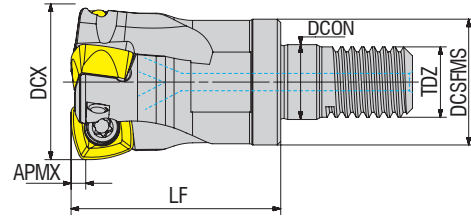

Takım Kodu Ordering Code Bestell-Bezeichnung	Stok Stock Lager	Takım Ölçüleri (mm) Dimension (mm) Abmessung (mm)							Kesici Uç Insert Wendeschneidplatte	Yedek Parçaları / Spare Parts / Ersatzteile			
		DCX	ZEFP	DCSFMS	TDZ	LF	DCON	APMX		Sıkma Vidası Screw Schraube	Baskı Parçası Wedge Clamp Spannpratze	Baskı Vidası Clamp Screw Schraube	Tork Anahtar Torx Key Torx-Schlüssel
AHFM-XD0904WD-D26-M12-L35-Z03-H	●	26	3	21	M12	35	12.5	1.5		4015-M3.5x9	-	-	
AHFM-XD0904WD-D33-M16-L43-Z04-H	●	33	4	29	M16	43	17	1.5					

R: Sağ / Right / Rechts/ L: Sol / Left / Links

● Stokta / In Stock / Auf Lager ○ Stokta Yok / Non Stock Item / Kein Lagerartikel, Lieferzeit auf Anfrage

WDA Ucuna Uygunudur. / Compatible with WDA Insert. / Kompatibel mit WDA Wendeplatten.

Sipariş Örneği/Ordering Example/Bestellbeispiel
1 ad./pcs./stück ATM-3BEI-D21-W25-L100-Z01-H
Kesme Hesabı : S 429 / Cutting Calculation : P 429 / Schnittberechnung : P 429
Sıkma Tork Değeri : S 428 / Tightening Torque : P 428 / Anzugsmoment : P 428

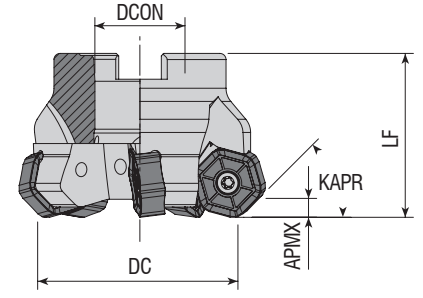

Takım Kodu Ordering Code Bestell-Bezeichnung	Stok Stock Lager	Takım Ölçüleri (mm) Dimension (mm) Abmessung (mm)					Kesici Uç Insert Wendeschneidplatte	Yedek Parçaları / Spare Parts / Ersatzteile			
		DC	ZEFP	DCON	LF	APMX		Sıkma Vidası Screw Schraube	Tork Anahtar Torx Key Torx-Schlüssel	Montaj Vidası Mounting Screw Befestigungsschraube	
AFM45-HN0905-D050-A22-Z05-H	●	50	5	22	40	4.5	HN.. 0905..	4015-M4x11	80-T15	-	2407-M10x30
AFM45-HN0905-D063-A22-Z06-H	●	63	6	22	40	4.5					2510-M12x35
AFM45-HN0905-D080-A27-Z07-H	●	80	7	27	50	4.5					2514-M16x35
AFM45L-HN0905-D100-A32-Z08-H	●	100	8	32	50	4.5					
AFM45-HN0905-D125-B40-Z10	●	125	10	40	63	4.5					
AFM45L-HN0905-D125-B40-Z10	●	125	10	40	63	4.5					
AFM45-HN0905-D160-C40-Z12	●	160	12	40	63	4.5					
AFM45L-HN0905-D160-C40-Z12	●	160	12	40	63	4.5					
AFM45-HN0905-D200-C60-Z16	●	200	16	60	63	4.5					
AFM45L-HN0905-D200-C60-Z16	●	200	16	60	63	4.5					

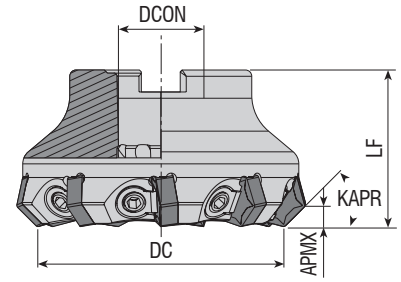

Takım Kodu Ordering Code Bestell-Bezeichnung	Stok Stock Lager	Takım Ölçüleri (mm) Dimension (mm) Abmessung (mm)					Kesici Uç Insert Wendeschneidplatte	Yedek Parçaları / Spare Parts / Ersatzteile			
		DC	ZEFP	DCON	LF	APMX		Baskı Parçası Wedge Clamp Spannpratze	Baskı Vidası Clamp Screw Klemmschraube	Anahtar Allen Key Innensechskantschlüssel	Montaj Vidası Mounting Screw Befestigungsschraube
AFM45C-HN0905-D063-A22-Z07	●	63	7	22	40	4.5	HN.. 0905..	ACK-11	AKV-15-M8x1x20	AAL-05-4	2508-M10x30
AFM45C-HN0905-D080-A27-Z09	●	80	9	27	50	4.5					2510-M12x35
AFM45C-HN0905-D100-A32-Z11	●	100	11	32	50	4.5					2514-M16x35
AFM45C-HN0905-D125-B40-Z13	●	125	13	40	63	4.5					
AFM45CL-HN0905-D125-B40-Z10	●	125	10	40	63	4.5					
AFM45C-HN0905-D160-C40-Z15	●	160	15	40	63	4.5					

R: Sağ / Right / Rechts/ L: Sol / Left / Links

● Stokta / In Stock / Auf Lager ○ Stokta Yok / Non Stock Item / Kein Lagerartikel, Lieferzeit auf Anfrage

WDA Ucuna Uygundur. / Compatible with WDA Insert. / Kompatibel mit WDA Wendeplatten.

Sipariş Örneği/Ordering Example/Bestellbeispiel

1 ad./pcs./stück AFM45-HN0905-D050-A22-Z05-H

Kesme Hesabı : S 429 / Cutting Calculation : P 429 / Schnittberechnung : P 429

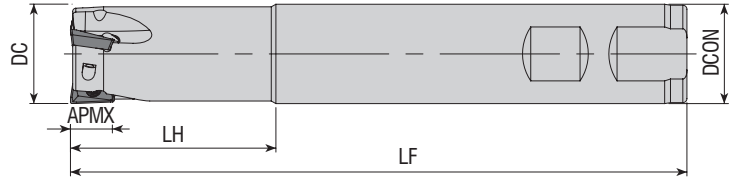

Takım Kodu Ordering Code Bestell-Bezeichnung	Stok Stock Lager	Takım Ölçüleri (mm) Dimension (mm) Abmessung (mm)						Kesici Uç Insert Wendeschneidplatte	Yedek Parçaları / Spare Parts / Ersatzteile		
		DC	ZEFP	DCON	LF	LH	APMX		Sıkma Vidası Screw Schraube	Tork Anahtar Torx Key Torx-Schlüssel	
AEM90-AD0803-D16-W16-L150-Z02	●	16	2	16	150	30	8	ADMT 0803..	3008-M2.5x5		
AEM90-AD0803-D17-W16-L150-Z02	●	17	2	16	150	30	8				
AEM90-AD0803-D17-W16-L200-Z02	●	17	2	16	200	30	8				
AEM90-AD0803-D20-W20-L150-Z03	●	20	3	20	150	30	8				
AEM90-AD0803-D21-W20-L200-Z03	●	21	3	20	200	30	8				
AEM90-AD10T3-D16-W16-L100-Z02-H	●	16	2	16	100	30	10	ADMT 10T3..	3008-M2.5x6	82-T08	
AEM90-AD10T3-D16-W16-L150-Z02	●	16	2	16	150	40	10				
AEM90-AD10T3-D16-C16-L200-Z02	●	16	2	16	200	50	10				
AEM90-AD10T3-D17-W16-L150-Z02	●	17	2	16	150	30	10				
AEM90-AD10T3-D17-W16-L200-Z02	●	17	2	16	200	30	10				
AEM90-AD10T3-D20-W20-L70-Z03	●	20	3	20	70	30	10				
AEM90-AD10T3-D20-W20-L100-Z03-H	●	20	3	20	100	30	10				
AEM90-AD10T3-D20-W20-L150-Z03	●	20	3	20	150	40	10				
AEM90-AD10T3-D20-C20-L150-Z03	●	20	3	20	150	40	10				
AEM90-AD10T3-D20-C20-L200-Z03	●	20	3	20	200	50	10				
AEM90-AD10T3-D25-W25-L100-Z03-H	●	25	3	25	100	30	10	ADMT 1204..	4010-M3x6	82-T10	
AEM90-AD10T3-D25-W25-L100-Z04-H	●	25	4	25	100	30	10				
AEM90-AD10T3-D25-W25-L150-Z03	●	25	3	25	150	50	10				
AEM90-AD1204-D20-W20-L150-Z02	●	20	2	20	150	50	12				
AEM90-AD1204-D21-C20-L150-Z02	●	21	2	20	150	30	12				
AEM90-AD1204-D22-C20-L150-Z02	●	22	2	20	150	30	12	ADMT 1606..	4015-M4x9	80-T15	
AEM90-AD1204-D25-W25-L150-Z03	●	25	3	25	150	50	12				
AEM90-AD1204-D26-W25-L180-Z03	●	26	3	25	180	30	12				
AEM90-AD1204-D32-W32-L150-Z04	●	32	4	32	150	50	12	ADMT 1606..	4015-M4x9	80-T15	
AEM90-AD1606-D25-W25-L150-Z02	●	25	2	25	150	50	15				
AEM90-AD1606-D32-W32-L150-Z03	●	32	3	32	150	50	15				

R: Sağ / Right / Rechts/ L: Sol / Left / Links

● Stokta / In Stock / Auf Lager ○ Stokta Yok / Non Stock Item / Kein Lagerartikel, Lieferzeit auf Anfrage

WLTR Ucuna Uygundur. / Compatible with WLTR Insert. / Kompatibel mit WLTR Wendeplatten.

Sipariş Örneği/Ordering Example/Bestellbeispiel
1 ad./pcs./stück AEM90-AD0803-D16-W16-L150-Z02
Kesme Hesabı : S 429 / Cutting Calculation : P 429 / Schnittberechnung : P 429

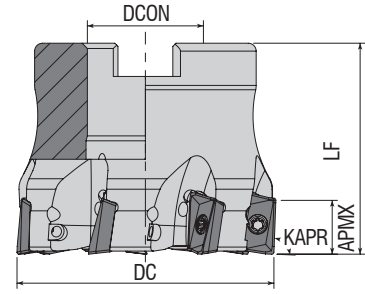

Takım Kodu
Ordering Code
Bestell-Bezeichnung

Stok
Stock
Lager

Takım Ölçüleri (mm)
Dimension (mm)
Abmessung (mm)

Kesici Uç
Insert
Wendeschneidplatte

Sıkma Vidası
Screw
Schraube

Tork Anahtar
Torx Key
Torx-Schlüssel

Montaj Vidası
Mounting Screw
Befestigungsschraube

Yedek Parçaları / Spare Parts / Ersatzteile

AFM90-AD10T3-D040-A16-Z06-H

●

40

6

16

40

10

ADMT 10T3..

3008-M2.5x6

82-T08

2506-M8x30

AFM90-AD10T3-D050-A22-Z07-H

●

50

7

22

40

10

2508-M10x30

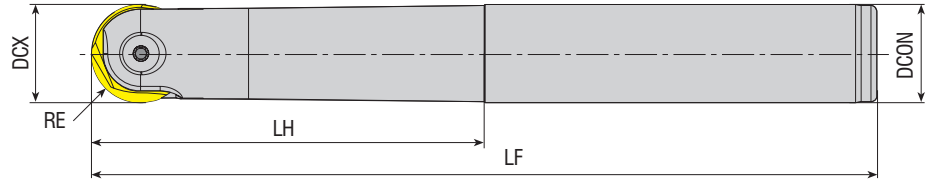

Takım Kodu
Ordering Code
Bestell-Bezeichnung

Stok
Stock
Lager

Takım Ölçüleri (mm)
Dimension (mm)
Abmessung (mm)

Kesici Uç
Insert
Wendeschneidplatte

Sıkma Vidası
Screw
Schraube

Tork Anahtar
Torx Key
Torx-Schlüssel

Yedek Parçaları / Spare Parts / Ersatzteile

APMR-P3208-D08-C10-L110

●

8

4

10

110

25

P3208

1208-M3x7

82-T08

APMR-P3210-D10-C10-L130

●

10

5

10

130

30

P3210

1215-M4x0.5x9

80-T15

APMR-P3210-D10-C12-L130

●

10

5

12

130

30

P3212

1220-M5x0.5x9

80-T20

APMR-P3212-D12-C12-L130

●

12

6

12

130

32

P3216

1220-M5x0.5x12

80-T20

APMR-P3216-D16-C16-L175

●

16

8

16

175

75

P3220

1220-M5x0.5x15

80-T20

APMR-P3220-D20-C20-L200

●

20

10

20

200

100

P3225

1220-M6x0.75x20

80-T20

APMR-P3225-D25-C25-L200

●

25

12.5

25

200

100

P3232

1204-M8x0.75x26

AAL-05-4

APMR-P3232-D32-C32-L200

●

32

16

32

200

100

P3232

1204-M8x0.75x26

AAL-05-4

R: Sağ / Right / Rechts/ L: Sol / Left / Links

● Stokta / In Stock / Auf Lager ○ Stokta Yok / Non Stock Item / Kein Lagerartikel, Lieferzeit auf Anfrage

WLTR Ucuna Uygundur. / Compatible with WLTR Insert. / Kompatibel mit WLTR Wendeplatten.

Sipariş Örneği/Ordering Example/Bestellbeispiel

1 ad./pcs./stück AFM90-AD10T3-D040-A16-Z06-H

Kesme Hesabı : S 429 / Cutting Calculation : P 429 / Schnittberechnung : P 429

Montaj Ölçüleri : S 426 / Mounting Reference : P 426 / Montagehinweis : P 426

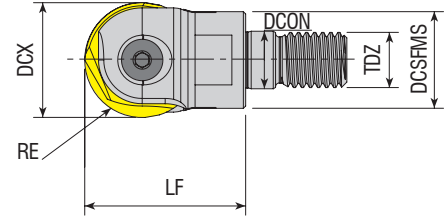

Takım Kodu Ordering Code Bestell-Bezeichnung	Stok Stock Lager	Takım Ölçüleri (mm) Dimension (mm) Abmessung (mm)						Kesici Uç Insert Wendeschneidplatte	Yedek Parçaları / Spare Parts / Ersatzteile		
		DCX	RE	DCSFMS	TDZ	LF	DCON		Sıkma Vidası Screw Schraube	Tork Anahtar Torx Key Torx-Schlüssel	
APMR-P3216-D16-M08-L25	●	16	8	14	M08	25	8.5				
APMR-P3220-D20-M10-L30	●	20	10	18	M10	30	10.5	P3220	1220-M5x0.5x15	80-T20	
APMR-P3225-D25-M12-L35	●	25	12.5	21	M12	35	12.5	P3225	1220-M6x0.75x20		
APMR-P3232-D32-M16-L43	●	32	16	29	M16	43	17	P3232	1204-M8x0.75x26	AAL-05-4	



KAPR=43°

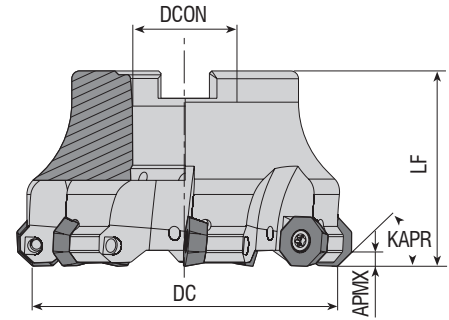

Takım Kodu Ordering Code Bestell-Bezeichnung	Stok Stock Lager	Takım Ölçüleri (mm) Dimension (mm) Abmessung (mm)					Kesici Uç Insert Wendeschneidplatte	Yedek Parçaları / Spare Parts / Ersatzteile			
		DC	ZEFP	DCON	LF	APMX		Sıkma Vidası Screw Schraube	Tork Anahtar Torx Key Torx-Schlüssel	Montaj Vidası Mounting Screw Befestigungsschraube	
AFM43-OD0504-D040-A16-Z04-H	●	40	4	16	40	3.5					
AFM43-OD0504-D050-A22-Z05-H	●	50	5	22	40	3.5					
AFM43-OD0504-D063-A22-Z06-H	●	63	6	22	40	3.5					
AFM43-OD0504-D080-A27-Z07-H	●	80	7	27	50	3.5					
AFM43-OD0504-D100-A32-Z08-H	●	100	8	32	50	3.5					

R: Sağ / Right / Rechts L: Sol / Left / Links

● Stokta / In Stock / Auf Lager ○ Stokta Yok / Non Stock Item / Kein Lagerartikel, Lieferzeit auf Anfrage

WLTR Ucuna Uygundur. / Compatible with WLTR Insert. / Kompatibel mit WLTR Wendeplatten.

Sipariş Örneği/Ordering Example/Bestellbeispiel
1 ad./pcs./stück APMR-P3216-D16-M08-L25

Kesme Hesabı : S 429 / Cutting Calculation : P 429 / Schnittberechnung : P 429
Sıkma Tork Değeri : S 428 / Tightening Torque : P 428 / Anzugsmoment : P 428

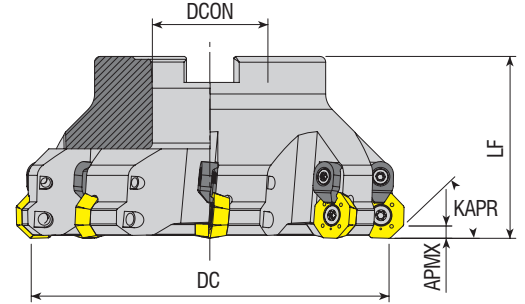

Takım Kodu Ordering Code Bestell-Bezeichnung	Stok Stock Lager	Takım Ölçüleri (mm) Dimension (mm) Abmessung (mm)					Kesici Uç Insert Wendeschneidplatte	Yedek Parçaları / Spare Parts / Ersatzteile									
		DC	ZEFP	DCON	LF	APMX		Sıkma Vidası Screw Schraube	Baskı Parçası Wedge Clamp Spannpratze	Baskı Vidası Clamp Screw Klemmschraube	Tork Anahtar Torx Key Torx-Schlüssel	Montaj Vidası Mounting Screw Befestigungsschraube					
AFM43C-OD0605-D080-A27-Z06-H	●	80	6	27	50	4	OD.. 0605..						2510-M12x35				
AFM43C-OD0605-D100-A32-Z07-H	●	100	7	32	50	4							1020-M5x11	ACK-05	4015-M4x11	80-T20	2514-M16x35
AFM43C-OD0605-D125-B40-Z08	●	125	8	40	63	4							-				

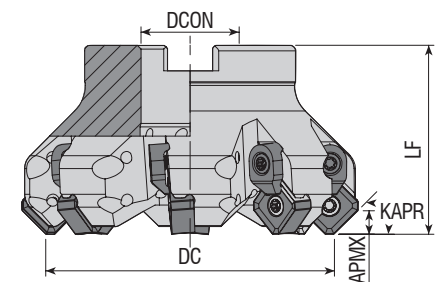
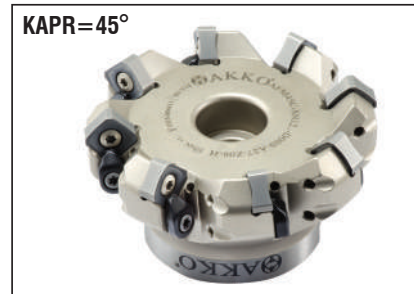

Takım Kodu Ordering Code Bestell-Bezeichnung	Stok Stock Lager	Takım Ölçüleri (mm) Dimension (mm) Abmessung (mm)					Kesici Uç Insert Wendeschneidplatte	Yedek Parçaları / Spare Parts / Ersatzteile					
		DC	ZEFP	DCON	LF	APMX		Sıkma Vidası Screw Schraube	Baskı Parçası Wedge Clamp Spannpratze	Baskı Vidası Clamp Screw Klemmschraube	Tork Anahtar Torx Key Torx-Schlüssel	Montaj Vidası Mounting Screw Befestigungsschraube	
AFM45C-SN12..-D050-A22-Z04-H	●	50	4	22	42	6	SN.. 12..						-
AFM45C-SN12..-D050-A22-Z05-H	●	50	5	22	42	6							-
AFM45C-SN12..-D063-A22-Z06-H	●	63	6	22	42	6							-
AFM45C-SN12..-D063-A22-Z07-H	●	63	7	22	42	6							-
AFM45CL-SN12..-D063-A22-Z07-H	●	63	7	22	42	6							-
AFM45C-SN12..-D080-A27-Z07-H	●	80	7	27	52	6							-
AFM45C-SN12..-D080-A27-Z08-H	●	80	8	27	52	6							-
AFM45CL-SN12..-D080-A27-Z08-H	●	80	8	27	52	6							-
AFM45C-SN12..-D100-A32-Z08-H	●	100	8	32	52	6							-
AFM45C-SN12..-D100-A32-Z10-H	●	100	10	32	52	6							-
AFM45CL-SN12..-D100-A32-Z10-H	●	100	10	32	52	6							-
AFM45C-SN12..-D125-B40-Z11	●	125	11	40	65	6							-
AFM45CL-SN12..-D125-B40-Z11	●	125	11	40	65	6							-
AFM45C-SN12..-D160-C40-Z12	●	160	12	40	65	6							-
AFM45C-SN12..-D200-C60-Z14	●	200	14	60	65	6							-
AFM45CL-SN12..-D200-C60-Z14	●	200	14	60	65	6							-

R: Sağ / Right / Rechts/ L: Sol / Left / Links

● Stokta / In Stock / Auf Lager ○ Stokta Yok / Non Stock Item / Kein Lagerartikel, Lieferzeit auf Anfrage

WLTR Ucuna Uygunudur. / Compatible with WLTR Insert. / Kompatibel mit WLTR Wendeplatten.

Sipariş Örneği/Ordering Example/Bestellbeispiel

1 ad./pcs./stück AFM43C-OD0605-D080-A27-Z06-H

Kesme Hesabı : S 429 / Cutting Calculation : P 429 / Schnittberechnung : P 429

Montaj Ölçüleri : S 426 / Mounting Reference : P 426 / Montagehinweis : P426

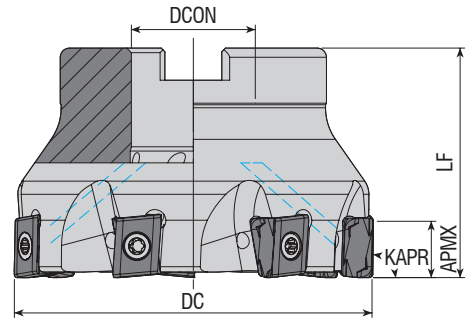

Takım Kodu
Ordering Code
Bestell-Bezeichnung

Takım Kodu Ordering Code Bestell-Bezeichnung	Stok Stock Lager	Takım Ölçüleri (mm) Dimension (mm) Abmessung (mm)					Kesici Uç Insert Wendeschneidplatte	Yedek Parçaları / Spare Parts / Ersatzteile		
		DC	ZEFP	DCON	LF	APMX		Sıkma Vidası Screw Schraube	Tork Anahtar Torx Key Torx-Schlüssel	Montaj Vidası Mounting Screw Befestigungsschraube
AFM90-LN1306W-D040-A16-Z04-H	●	40	4	16	40	12	LNHU 1306..	4115-M4x12	80-T15	2506-M8x30
AFM90-LN1306W-D050-A22-Z05-H	●	50	5	22	40	12				2508-M10x30
AFM90-LN1306W-D063-A22-Z06-H	●	63	6	22	40	12				2510-M12x35
AFM90-LN1306W-D080-A27-Z07-H	●	80	7	27	50	12				2514-M16x35
AFM90-LN1306W-D100-A32-Z08-H	●	100	8	32	50	12				

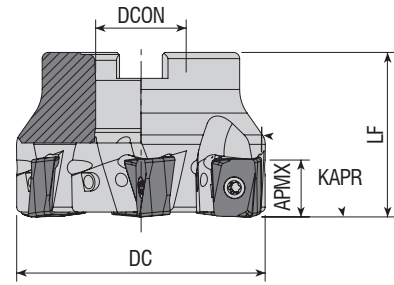

Takım Kodu
Ordering Code
Bestell-Bezeichnung

Takım Kodu Ordering Code Bestell-Bezeichnung	Stok Stock Lager	Takım Ölçüleri (mm) Dimension (mm) Abmessung (mm)					Kesici Uç Insert Wendeschneidplatte	Yedek Parçaları / Spare Parts / Ersatzteile		
		DC	ZEFP	DCON	LF	APMX		Sıkma Vidası Screw Schraube	Tork Anahtar Torx Key Torx-Schlüssel	Montaj Vidası Mounting Screw Befestigungsschraube
AFM90-LN1307-D050-A22-Z04-H	●	50	4	22	40	13	LNGX 1307..	1315-M4x11	80-T15	2508-M10x30
AFM90-LN1307-D063-A22-Z06-H	●	63	6	22	40	13				2510-M12x35
AFM90-LN1307-D080-A27-Z07-H	●	80	7	27	50	13				2514-M16x35
AFM90-LN1307-D100-A32-Z08-H	●	100	8	32	50	13				

R: Sağ / Right / Rechts L: Sol / Left / Links

● Stokta / In Stock / Auf Lager ○ Stokta Yok / Non Stock Item / Kein Lagerartikel, Lieferzeit auf Anfrage

WLTR Ucuna Uygundur. / Compatible with WLTR Insert. / Kompatibel mit WLTR Wendeplatten.

Sipariş Örneği/Ordering Example/Bestellbeispiel

1 ad./pcs./stück AFM90-LN1306W-D040-A16-Z04-H

Kesme Hesabı : S 429 / Cutting Calculation : P 429 / Schnittberechnung : P 429

Montaj Ölçüleri : S 426 / Mounting Reference : P 426 / Montagehinweis : P426

WLTR Ucuna Uygundur. / Compatible with WLTR Insert. / Kompatibel mit WLTR Wendeplatten.

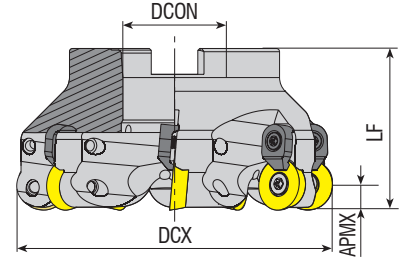
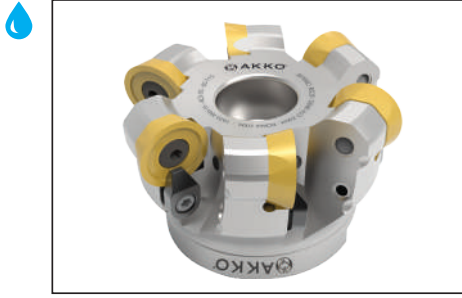

Takım Kodu
Ordering Code
Bestell-Bezeichnung

Takım Kodu Ordering Code Bestell-Bezeichnung	Stok Stock Lager	Takım Ölçüleri (mm) Dimension (mm) Abmessung (mm)					Kesici Uç Insert Wendeschneidplatte	Yedek Parçaları / Spare Parts / Ersatzteile				
		DC	ZEFP	DCON	LF	APMX		Sıkma Vidası Screw Schraube	Baskı Parçası Wedge Clamp Spannpratze	Baskı Vidası Clamp Screw Klemmschraube	Tork Anahtar Torx Key Torx-Schlüssel	Montaj Vidası Mounting Screw Befestigungsschraube
AFMRC-R020-D063-A22-Z05-H	●	63	5	22	50	10	ROMX 2006					2508-M10X30
AFMRC-R020-D080-A27-Z06-H	●	80	6	27	50	10						1020-M6x16

WLTR Ucuna Uygundur. / Compatible with WLTR Insert. / Kompatibel mit WLTR Wendeplatten.

XTC-GSC Ucuna Uygundur. / Compatible with XTC-GSC Insert. / Kompatibel mit XTC-GSC Wendeplatten.

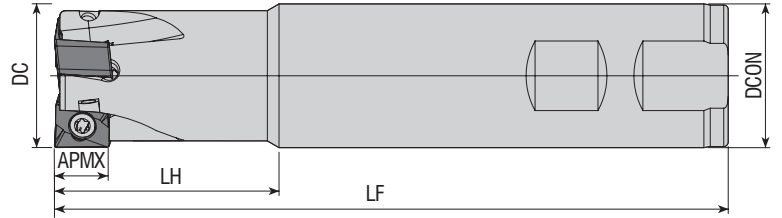

Takım Kodu
Ordering Code
Bestell-Bezeichnung

Takım Kodu Ordering Code Bestell-Bezeichnung	Stok Stock Lager	Takım Ölçüleri (mm) Dimension (mm) Abmessung (mm)						Kesici Uç Insert Wendeschneidplatte	Yedek Parçaları / Spare Parts / Ersatzteile				
		DC	ZEFP	DCON	LF	LH	APMX		Sıkma Vidası Screw Schraube	Tork Anahtar Torx Key Torx-Schlüssel			
AEM90-AN1207-D25-W25-L150-Z02	●	25	2	25	150	40	10						
AEM90-AN1207-D32-W32-L150-Z03	●	32	3	32	150	50	10				ANKX 1207..	4015-M4x11	80-T15
AEM90-AN1207-D40-W32-L150-Z04	●	40	4	32	150	40	10						

R: Sağ / Right / Rechts/ L: Sol / Left / Links

● Stokta / In Stock / Auf Lager ○ Stokta Yok / Non Stock Item / Kein Lagerartikel, Lieferzeit auf Anfrage

XTC-GSC Ucuna Uygundur. / Compatible with XTC-GSC Insert. / Kompatibel mit XTC-GSC Wendeplatten.

Sipariş Örneği/Ordering Example/Bestellbeispiel

1 ad./pcs./stück AFMRC-R020-D063-A22-Z05-H

Kesme Hesabı : S 429 / Cutting Calculation : P 429 / Schnittberechnung : P 429

Montaj Ölçüleri : S 426 / Mounting Reference : P 426 / Montagehinweis : P426

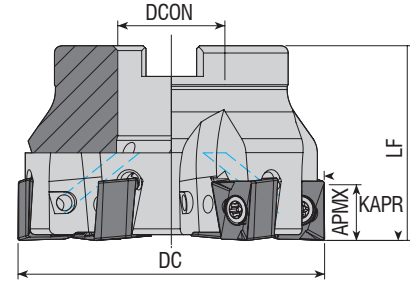

Takım Kodu Ordering Code Bestell-Bezeichnung	Stok Stock Lager	Takım Ölçüleri (mm) Dimension (mm) Abmessung (mm)					Kesici Uç Insert Wendeschneidplatte	Yedek Parçaları / Spare Parts / Ersatzteile		
		DC	ZEFP	DCON	LF	APMX		Sıkma Vidası Screw Schraube	Tork Anahtar Torx Key Torx-Schlüssel	Montaj Vidası Mounting Screw Befestigungsschraube
AFM90-AN1207-D040-A16-Z04-H	●	40	4	16	40	10	ANKX 1207..	4015-M4x11	80-T15	2506-M8x30
AFM90-AN1207-D050-A22-Z05-H	●	50	5	22	40	10				2508-M10x30
AFM90-AN1207-D063-A22-Z06-H	●	63	6	22	40	10				2510-M12x35
AFM90-AN1607X-D050-A22-Z04-H	●	50	4	22	40	15	ANKX 1607..	4015-M4x11	80-T15	2508-M10x30
AFM90-AN1607X-D063-A22-Z06-H	●	63	6	22	40	15				2510-M12x35
AFM90-AN1607X-D080-A27-Z07-H	●	80	7	27	50	15				2510-M12x35

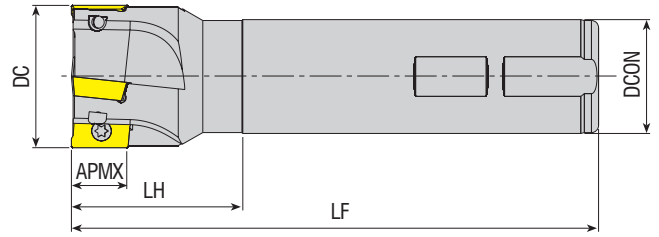

Takım Kodu Ordering Code Bestell-Bezeichnung	Stok Stock Lager	Takım Ölçüleri (mm) Dimension (mm) Abmessung (mm)						Kesici Uç Insert Wendeschneidplatte	Yedek Parçaları / Spare Parts / Ersatzteile	
		DC	ZEFP	DCON	LF	LH	APMX		Sıkma Vidası Screw Schraube	Tork Anahtar Torx Key Torx-Schlüssel
AEM90-AP1135-D16-W16-L110-Z02-H	●	16	2	16	110	30	9.5	AP. 1135..	3008-M2.5x6	82-T08
AEM90-AP1135-D16-W16-L150-Z02	●	16	2	16	150	50	9.5			
AEM90-AP1135-D20-W20-L125-Z03-H	●	20	3	20	125	30	9.5			
AEM90-AP1135-D20-W20-L150-Z03	●	20	3	20	150	50	9.5			
AEM90-AP1135-D25-W25-L125-Z04-H	●	25	4	25	125	30	9.5			
AEM90-AP1135-D25-W25-L200-Z04-H	●	25	4	25	200	100	9.5			
AEM90-AP1135-D32-W32-L125-Z05-H	●	32	5	32	125	30	9.5			
AEM90-AP1135-D32-W32-L200-Z04-H	●	32	4	32	200	100	9.5	APKT 1135..	3008-M3x5 3008-M3x6	
AEM90-AP1135G-D16-W16-L150-Z02	●	16	2	16	150	26	11			
AEM90-AP1135G-D20-W20-L150-Z03	●	20	3	20	150	26	11			
AEM90-AP1135G-D25-W25-L150-Z03	●	25	3	25	150	26	11			

R: Sağ / Right / Rechts/ L: Sol / Left / Links

● Stokta / In Stock / Auf Lager ○ Stokta Yok / Non Stock Item / Kein Lagerartikel, Lieferzeit auf Anfrage

XTC-GSC Ucuna Uygundur. / Compatible with XTC-GSC Insert. / Kompatibel mit XTC-GSC Wendeplatten.

Sipariş Örneği/Ordering Example/Bestellbeispiel

1 ad./pcs./stück AFM90-AN1207-D040-A16-Z04-H

Kesme Hesabı : S 429 / Cutting Calculation : P 429 / Schnittberechnung : P 429

XTC-GSC Ucuna Uygun. / Compatible with XTC-GSC Insert. / Kompatibel mit XTC-GSC Wendeplatten.

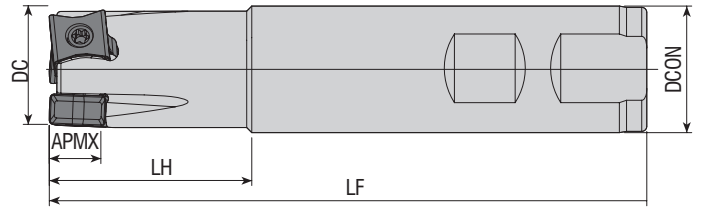

Takım Kodu Ordering Code Bestell-Bezeichnung	Stok Stock Lager	Takım Ölçüleri (mm) Dimension (mm) Abmessung (mm)						Kesici Uç Insert Wendeschneidplatte	Yedek Parçaları / Spare Parts / Ersatzteile		
		DC	ZEFP	DCON	LF	LH	APMX		Sıkma Vidası Screw Schraube	Tork Anahtar Torx Key Torx-Schlüssel	
AEM90-LN1106-D25-W25-L150-Z03	●	25	3	25	150	40	10	LNMT 1106..		4015-M3.5x11	
AEM90-LN1106-D32-W32-L150-Z04	●	32	4	32	150	40	10				
AEM90-LN1106-D40-W32-L150-Z05	●	40	5	32	150	40	10				

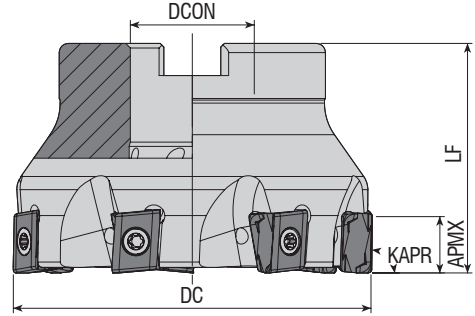

Takım Kodu Ordering Code Bestell-Bezeichnung	Stok Stock Lager	Takım Ölçüleri (mm) Dimension (mm) Abmessung (mm)					Kesici Uç Insert Wendeschneidplatte	Yedek Parçaları / Spare Parts / Ersatzteile			
		DC	ZEFP	DCON	LF	APMX		Sıkma Vidası Screw Schraube	Tork Anahtar Torx Key Torx-Schlüssel	Montaj Vidası Mounting Screw Befestigungsschraube	
AFM90-LN1506X-D063-A22-Z06	●	63	6	22	40	7	LNMT 1506..				
AFM90-LN1506X-D080-A27-Z07	●	80	7	27	50	7					
AFM90-LN1506X-D100-A32-Z08	●	100	8	32	50	7					

R: Sağ / Right / Rechts / L: Sol / Left / Links

● Stokta / In Stock / Auf Lager ○ Stokta Yok / Non Stock Item / Kein Lagerartikel, Lieferzeit auf Anfrage

XTC-GSC Ucuna Uygun. / Compatible with XTC-GSC Insert. / Kompatibel mit XTC-GSC Wendeplatten.

Sipariş Örneği/Ordering Example/Bestellbeispiel

1 ad./pcs./stück AEM90-WNG04-D20-W20-L81-Z02-H

Kesme Hesabı : S 429 / Cutting Calculation : P 429 / Schnittberechnung : P 429

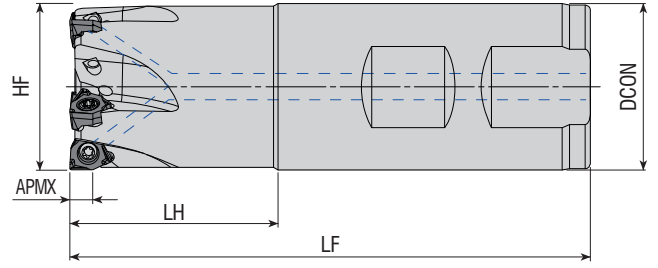

Takım Kodu Ordering Code Bestell-Bezeichnung	Stok Stock Lager	Takım Ölçüleri (mm) Dimension (mm) Abmessung (mm)						Kesici Uç Insert Wendescheidplatte	Yedek Parçaları / Spare Parts / Ersatzteile	
		DC	ZEFP	DCON	LF	LH	APMX		Sıkma Vidası Screw Schraube	Tork Anahtar Torx Key Torx-Schlüssel
AEM90-WNG04-D20-W20-L81-Z02-H	●	20	2	20	81	31	4	WNGU 0403..	3008-M3x6	82-T08
AEM90-WNG04-D20-W20-L81-Z03-H	●	20	3	20	81	31	4			
AEM90-WNG04-D20-C20-L170-Z02-H	●	20	2	20	170	50	4			
AEM90-WNG04-D20-C20-L170-Z03-H	●	20	3	20	170	50	4			
AEM90-WNG04-D25-W25-L88-Z03-H	●	25	3	25	88	32	4			
AEM90-WNG04-D25-W25-L88-Z04-H	●	25	4	25	88	32	4			
AEM90-WNG04-D25-C25-L170-Z02-H	●	25	2	25	170	50	4			
AEM90-WNG04-D25-C25-L170-Z03-H	●	25	3	25	170	50	4			
AEM90-WNG04-D32-W25-L100-Z05-H	●	32	5	25	100	35	4			
AEM90-WNG04-D32-W32-L100-Z05-H	●	32	5	32	100	40	4			
AEM90-WNG04-D32-C32-L170-Z03-H	●	32	3	32	170	50	4			
AEM90-WNG04-D32-C25-L170-Z04-H	●	32	4	25	170	35	4			
AEM90-WNG04-D32-C32-L170-Z04-H	●	32	4	32	170	50	4			
AEM90-WNG08-D32-C32-L170-Z02-H	●	32	2	32	170	50	7.5	WNGU 0806..	4015-M4x11	80-T15
AEM90-WNG08-D40-W32-L100-Z03-H	●	40	3	32	100	35	7.5			
AEM90-WNG08-D40-W40-L110-Z03-H	●	40	3	40	110	40	7.5			
AEM90-WNG08-D40-C32-L170-Z03-H	●	40	3	32	170	35	7.5			

R: Sağ / Right / Rechts/ L: Sol / Left / Links

● Stokta / In Stock / Auf Lager ○ Stokta Yok / Non Stock Item / Kein Lagerartikel, Lieferzeit auf Anfrage

XTC-GSC Ucuna Uygundur. / Compatible with XTC-GSC Insert. / Kompatibel mit XTC-GSC Wendeplatten.

Sipariş Örneği/Ordering Example/Bestellbeispiel

1 ad./pcs./stück AEM90-WNG04-D20-W20-L81-Z02-H

Kesme Hesabı : S 429 / Cutting Calculation : P 429 / Schnittberechnung : P 429

XTC-GSC Ucuna Uygundur. / Compatible with **XTC-GSC** Insert. / Kompatibel mit **XTC-GSC** Wendeplatten.

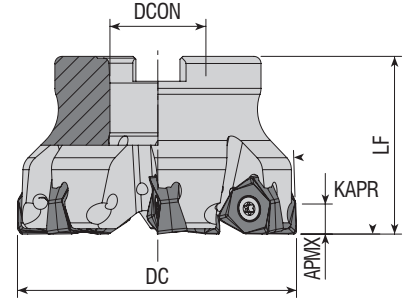

Takım Kodu Ordering Code Bestell-Bezeichnung	Stok Stock Lager	Takım Ölçüleri (mm) Dimension (mm) Abmessung (mm)					Kesici Uç Insert Wendeschneidplatte	Yedek Parçaları / Spare Parts / Ersatzteile					
		DC	ZEFP	DCON	LF	APMX		Sıkma Vidası Screw Schraube	Tork Anahtar Torx Key Torx-Schlüssel	Montaj Vidası Mounting Screw Befestigungsschraube			
AFM90-WNG04-D040-A16-Z06-H	●	40	6	16	40	4	WNGU 0403..	3008-M3x6	82-T08	2506-M8x30			
AFM90-WNG04-D050-A22-Z05-H	●	50	5	22	40	4				WNGU 0806..	4015-M4x11	80-T15	2508-M10x30
AFM90-WNG04-D050-A22-Z07-H	●	50	7	22	40	4							2510-M12x35
AFM90-WNG04-D063-A22-Z06-H	●	63	6	22	40	4							
AFM90-WNG08-D050-A22-Z05-H	●	50	5	22	40	7.5	WNGU 0806..	4015-M4x11	80-T15				2510-M12x35
AFM90-WNG08-D063-A22-Z06-H	●	63	6	22	40	7.5				2514-M16x35			
AFM90-WNG08-D080-A27-Z07-H	●	80	7	27	50	7.5					2514-M16x35		
AFM90-WNG08-D100-A32-Z07-H	●	100	10	32	50	7.5							

XTC-GSC Ucuna Uygundur. / Compatible with **XTC-GSC** Insert. / Kompatibel mit **XTC-GSC** Wendeplatten.

YG Ucuna Uygundur. / Compatible with **YG** Insert. / Kompatibel mit **YG** Wendeplatten.

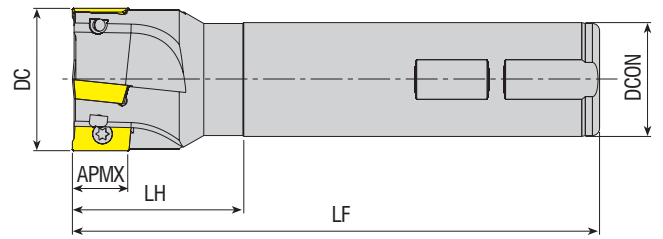

Takım Kodu Ordering Code Bestell-Bezeichnung	Stok Stock Lager	Takım Ölçüleri (mm) Dimension (mm) Abmessung (mm)						Kesici Uç Insert Wendeschneidplatte	Yedek Parçaları / Spare Parts / Ersatzteile	
		DC	ZEFP	DCON	LF	LH	APMX		Sıkma Vidası Screw Schraube	Tork Anahtar Torx Key Torx-Schlüssel
AEM90-AP1135Y-D16-C16-L120-Z02-H	●	16	2	16	120	30	9.5	APMT 1135..	3008-M2.5x6	82-T08
AEM90-AP1135Y-D16-W16-L150-Z02	●	16	2	16	150	50	9.5			
AEM90-AP1135Y-D17-C16-L150-Z02	●	17	2	16	150	30	9.5			
AEM90-AP1135Y-D20-C20-L120-Z02	●	20	2	20	120	30	9.5			
AEM90-AP1135Y-D20-W20-L150-Z03	●	20	3	20	150	50	9.5			
AEM90-AP1135Y-D21-C20-L150-Z03	●	21	3	20	150	30	9.5			
AEM90-AP1135Y-D25-W25-L150-Z03	●	25	3	25	150	50	9.5			
AEM90-AP1135Y-D25-C25-L150-Z04-H	●	25	4	25	150	30	9.5			
AEM90-AP1135Y-D26-C25-L150-Z03	●	26	3	25	150	35	9.5			
AEM90-AP1135Y-D32-W25-L110-Z04	●	32	4	25	110	35	9.5			
AEM90-AP16Y-D25-C20-L100-Z02-H	●	25	2	20	100	35	16	AP. 1604..	4015-M4x9	80-T15
AEM90-AP16Y-D25-C25-L120-Z02	●	25	2	25	120	50	16			
AEM90-AP16Y-D25-C25-L150-Z02	●	25	2	25	150	50	16			
AEM90-AP16Y-D25-C25-L250-Z02	●	25	2	25	250	100	16			

YG Ucuna Uygundur. / Compatible with **YG** Insert. / Kompatibel mit **YG** Wendeplatten.

Kesme Hesabı : S 429 / Cutting Calculation : P 429 / Schnittberechnung : P 429

YG Ucuna Uygundur. / Compatible with YG Insert. / Kompatibel mit YG Wendeplatten.

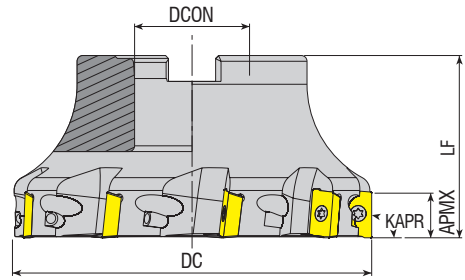
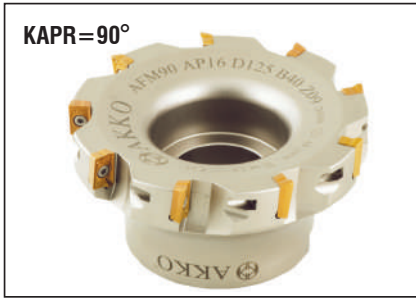

Takım Kodu Ordering Code Bestell-Bezeichnung	Stok Stock Lager	Takım Ölçüleri (mm) Dimension (mm) Abmessung (mm)					Kesici Uç Insert Wendeschneidplatte	Yedek Parçaları / Spare Parts / Ersatzteile				
		DC	ZEFP	DCON	LF	APMX		Sıkma Vidası Screw Schraube	Tork Anahtar Torx Key Torx-Schlüssel	Montaj Vidası Mounting Screw Befestigungsschraube		
AFM90-AP16Y-D040-A16-Z04-H	●	40	4	16	40	16	AP. 1604..		4015-M4x11		80-T15	2506-M8x30
AFM90-AP16Y-D050-A22-Z05-H	●	50	5	22	40	16						2508-M10x30
AFM90-AP16Y-D063-A22-Z06-H	●	63	6	22	40	16						2510-M12x35
AFM90-AP16Y-D080-A27-Z07-H	●	80	7	27	50	16						
AFM90-AP16Y-D100-A32-Z08-H	●	100	8	32	50	16						

YG Ucuna Uygundur. / Compatible with YG Insert. / Kompatibel mit YG Wendeplatten.

ZCC Ucuna Uygundur. / Compatible with ZCC Insert. / Kompatibel mit ZCC Wendeplatten.

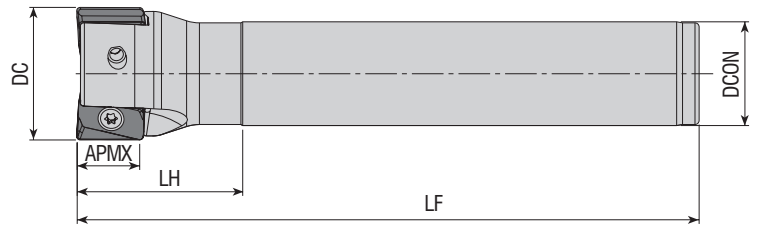

Takım Kodu Ordering Code Bestell-Bezeichnung	Stok Stock Lager	Takım Ölçüleri (mm) Dimension (mm) Abmessung (mm)						Kesici Uç Insert Wendeschneidplatte	Yedek Parçaları / Spare Parts / Ersatzteile			
		DC	ZEFP	DCON	LF	LH	APMX		Sıkma Vidası Screw Schraube	Tork Anahtar Torx Key Torx-Schlüssel		
AEM90-AN11-D22-W20-L150-Z02	●	22	2	20	150	30	11	ANGX 1105..			4010-M3x8	82-T10
AEM90-AN11-D25-W25-L150-Z02	●	25	2	25	150	40	11					
AEM90-AN11-D25-C25-L200-Z02	●	25	2	25	200	40	11					
AEM90-AN11-D26-W25-L150-Z02	●	26	2	25	150	40	11					
AEM90-AN11-D28-W25-L150-Z02	●	28	2	25	150	25	11					
AEM90-AN11-D32-W32-L150-Z03	●	32	3	32	150	50	11					
AEM90-AN11-D32-C32-L200-Z03	●	32	3	32	200	50	11					
AEM90-AN11-D40-W32-L150-Z04	●	40	4	32	150	40	11					

R: Sağ / Right / Rechts/ L: Sol / Left / Links

● Stokta / In Stock / Auf Lager ○ Stokta Yok / Non Stock Item / Kein Lagerartikel, Lieferzeit auf Anfrage

ZCC Ucuna Uygundur. / Compatible with ZCC Insert. / Kompatibel mit ZCC Wendeplatten.

Sipariş Örneği/Ordering Example/Bestellbeispiel

1 ad./pcs./stück AFM90-AP16A-D125-B40-Z09

Kesme Hesabı : S 429 / Cutting Calculation : P 429 / Schnittberechnung : P 429

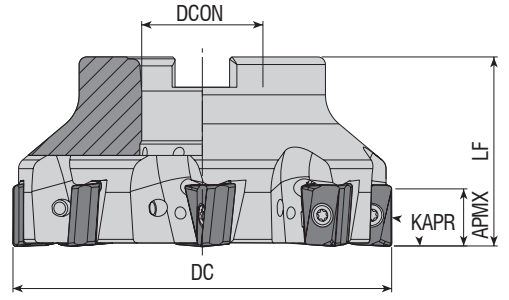

Takım Kodu Ordering Code Bestell-Bezeichnung	Stok Stock Lager	Takım Ölçüleri (mm) Dimension (mm) Abmessung (mm)					Kesici Uç Insert Wendeschneidplatte	Yedek Parçaları / Spare Parts / Ersatzteile		
		DC	ZEPF	DCON	LF	APMX		Sıkma Vidası Screw Schraube	Tork Anahtar Torx Key Torx-Schlüssel	Montaj Vidası Mounting Screw Befestigungsschraube
AFM90-AN11-D040-A16-Z04-H	●	40	4	16	40	11	ANGX 1105..	4010-M3x8	82-T10	2506-M8x30
AFM90-AN1506-D050-A22-Z04-H	●	50	4	22	40	14.5				2508-M10x30
AFM90-AN1506-D063-A22-Z05-H	●	63	5	22	40	14.5	ANGX 1506..	4015-M4x12	80-T15	2510-M12x35
AFM90-AN1506-D080-A27-Z06-H	●	80	6	27	50	14.5				2514-M16x35
AFM90-AN1506-D100-A32-Z08-H	●	100	8	32	50	14.5				-
AFM90-AN1506-D125-B40-Z09	●	125	9	40	63	14.5				-
AFM90-AN1506-D160-C40-Z10	●	160	10	40	63	14.5	-	-	-	

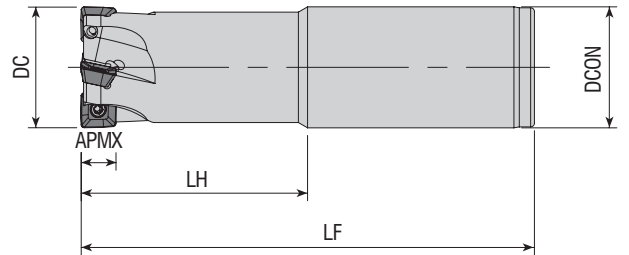

Takım Kodu Ordering Code Bestell-Bezeichnung	Stok Stock Lager	Takım Ölçüleri (mm) Dimension (mm) Abmessung (mm)						Kesici Uç Insert Wendeschneidplatte	Yedek Parçaları / Spare Parts / Ersatzteile	
		DC	ZEPF	DCON	LF	LH	APMX		Sıkma Vidası Screw Schraube	Tork Anahtar Torx Key Torx-Schlüssel
AEM90-SE09-D25-C25-L120-Z03-H	●	25	3	25	120	60	6.7	SEET 09T3..	3008-M3x8	82-T08
AEM90-SE09-D25-C25-L150-Z02	●	25	2	25	150	50	6.7			
AEM90-SE09-D32-C32-L120-Z04-H	●	32	4	32	120	60	6.7			
AEM90-SE09-D32-C32-L150-Z03	●	32	3	32	150	50	6.7			

R: Sağ / Right / Rechts/ L: Sol / Left / Links

● Stokta / In Stock / Auf Lager ○ Stokta Yok / Non Stock Item / Kein Lagerartikel, Lieferzeit auf Anfrage

ZCC Ucuna Uygundur. / Compatible with ZCC Insert. / Kompatibel mit ZCC Wendeplatten.

Sipariş Örneği/Ordering Example/Bestellbeispiel/

1 ad./pcs./stück AFM90-AN11-D040-A16-Z04-H

Kesme Hesabı : S 429 / Cutting Calculation : P 429 / Schnittberechnung : P 429

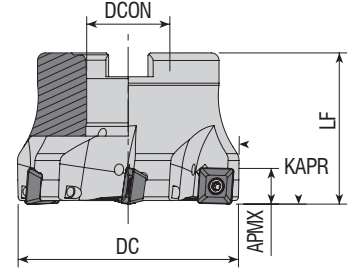

Takım Kodu Ordering Code Bestell-Bezeichnung	Stok Stock Lager	Takım Ölçüleri (mm) Dimension (mm) Abmessung (mm)					Kesici Uç Insert Wendeschneidplatte	Yedek Parçaları / Spare Parts / Ersatzteile				
		DC	ZEFP	DCON	LF	APMX		Sıkma Vidası Screw Schraube	Tork Anahtar Torx Key Torx-Schlüssel	Montaj Vidası Mounting Screw Befestigungsschraube		
AFM90-SE09-D040-A16-Z04-H	●	40	4	16	40	6.7	SEET 09T3..			2506-M8x30		
AFM90-SE09-D050-A22-Z05-H	●	50	5	22	40	6.7				3008-M3x8	82-T08	2508-M10x30
AFM90-SE09-D063-A22-Z06-H	●	63	6	22	40	6.7						

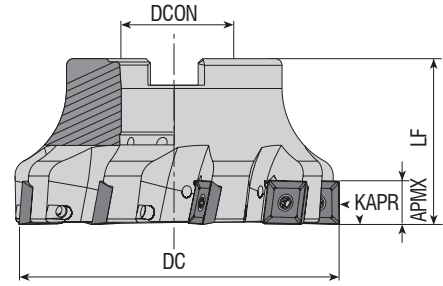

Takım Kodu Ordering Code Bestell-Bezeichnung	Stok Stock Lager	Takım Ölçüleri (mm) Dimension (mm) Abmessung (mm)					Kesici Uç Insert Wendeschneidplatte	Yedek Parçaları / Spare Parts / Ersatzteile				
		DC	ZEFP	DCON	LF	APMX		Sıkma Vidası Screw Schraube	Tork Anahtar Torx Key Torx-Schlüssel	Montaj Vidası Mounting Screw Befestigungsschraube		
AFM90-SE12-D050-A22-Z04-H	●	50	4	22	40	12	SEET 1203..			2508-M10x30		
AFM90-SE12-D063-A22-Z05-H	●	63	5	22	40	12				4015-M3.5x11	80-T15	2510-M12x35
AFM90-SE12-D080-A27-Z07-H	●	80	7	27	50	12						2514-M16x35
AFM90-SE12-D100-A32-Z09-H	●	100	9	32	50	12						-
AFM90-SE12-D125-B40-Z11	●	125	11	40	63	12						

R: Sağ / Right / Rechts/ L: Sol / Left / Links

● Stokta / In Stock / Auf Lager ○ Stokta Yok / Non Stock Item / Kein Lagerartikel, Lieferzeit auf Anfrage

ZCC Ucuna Uygunudur. / Compatible with ZCC Insert. / Kompatibel mit ZCC Wendeplatten.

Sipariş Örneği/Ordering Example/Bestellbeispiel

1 ad./pcs./stück AFM90-SE09-D040-A16-Z04-H

Kesme Hesabı : S 429 / Cutting Calculation : P 429 / Schnittberechnung : P 429

Montaj Ölçüleri : S 426 / Mounting Reference : P 426 / Montagehinweis : P 426

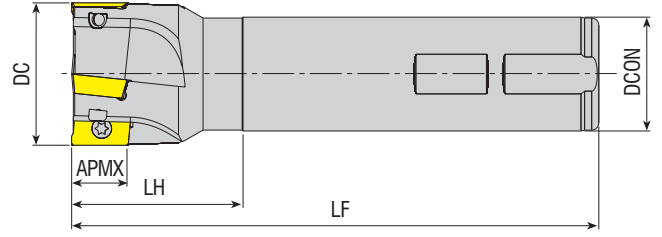

Takım Kodu Ordering Code Bestell-Bezeichnung	Stok Stock Lager	Takım Ölçüleri (mm) Dimension (mm) Abmessung (mm)						Kesici Uç Insert Wendeschneidplatte	Yedek Parçaları / Spare Parts / Ersatzteile	
		DC	ZEFP	DCON	LF	LH	APMX		Sıkma Vidası Screw Schraube	Tork Anahtar Torx Key Torx-Schlüssel
AEM90-AP11-D16-C16-L150-Z02	●	16	2	16	150	50	11	AP. 11T3..	3008-M2.5x6	82-T08
AEM90-AP11-D16-C16-L150-Z02-H	●	16	2	16	150	50	11			
AEM90-AP11-D16-W16-L150-Z02	●	16	2	16	150	50	11			
AEM90-AP11-D16-W16-L150-Z02-H	●	16	2	16	150	50	11			
AEM90-AP11-D16-C16-L200-Z02	●	16	2	16	200	100	11			
AEM90-AP11-D17-C16-L150-Z02	●	17	2	16	150	30	11			
AEM90-AP11-D17-C16-L200-Z02	●	17	2	16	200	30	11			
AEM90-AP11-D20-C20-L150-Z03	●	20	3	20	150	50	11			
AEM90-AP11-D20-W20-L150-Z03	●	20	3	20	150	50	11			
AEM90-AP11-D20-W20-L150-Z03-H	●	20	3	20	150	50	11			
AEM90-AP11-D20-C20-L200-Z03	●	20	3	20	200	100	11			
AEM90-AP11-D21-C20-L150-Z03	●	21	3	20	150	30	11			
AEM90-AP11-D21-W20-L150-Z03	●	21	3	20	150	30	11			
AEM90-AP11-D21-W20-L150-Z03-H	●	21	3	20	150	30	11			
AEM90-AP11-D21-C20-L200-Z03	●	21	3	20	200	30	11			
AEM90-AP11-D22-C20-L180-Z03-H	●	22	3	20	180	30	11			
AEM90-AP11-D25-C25-L150-Z03	●	25	3	25	150	50	11			
AEM90-AP11-D25-W25-L150-Z03	●	25	3	25	150	50	11			
AEM90-AP11-D25-W25-L150-Z03-H	●	25	3	25	150	50	11			
AEM90-AP11-D26-C25-L150-Z03	●	26	3	25	150	35	11			
AEM90-AP11-D26-C24-L150-Z03	●	26	3	24	150	35	11			
AEM90-AP11-D28-C25-L180-Z03-H	●	28	3	25	180	30	11			
AEM90-AP11-D32-W25-L150-Z04	●	32	4	25	150	35	11			
AEM90-AP11-D32-W32-L150-Z03-H	●	32	3	32	150	50	11			
AEM90-AP11-D32-W32-L150-Z04	●	32	4	32	150	50	11			

R: Sağ / Right / Rechtsl L: Sol / Left / Links

● Stokta / In Stock / Auf Lager ○ Stokta Yok / Non Stock Item / Kein Lagerartikel, Lieferzeit auf Anfrage

ZCC Ucuna Uygundur. / Compatible with ZCC Insert. / Kompatibel mit ZCC Wendeplatten.

Sipariş Örneği/Ordering Example/Bestellbeispiel

1 ad./pcs./stück AEM90-AP11-D16-C16-L150-Z02

Kesme Hesabı : S 429 / Cutting Calculation : P 429 / Schnittberechnung : P 429

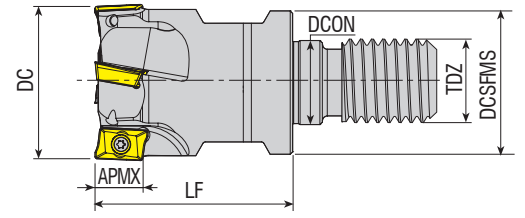

Takım Kodu Ordering Code Bestell-Bezeichnung	Stok Stock Lager	Takım Ölçüleri (mm) Dimension (mm) Abmessung (mm)							Kesici Uç Insert Wendeschneidplatte	Yedek Parçaları / Spare Parts / Ersatzteile	
		DC	ZEFP	DCSFMS	TDZ	LF	DCON	APMX		Sıkma Vidası Screw Schraube	Tork Anahtar Torx Key Torx-Schlüssel
AEM90-AP11-D16-M08-L30-Z02-H	●	16	2	14.75	M08	30	8.5	11	AP. 11T3..		82-T08
AEM90-AP11-D20-M10-L30-Z03-H	●	20	3	18	M10	30	10.5	11			
AEM90-AP11-D25-M12-L35-Z03-H	●	25	3	21	M12	35	12.5	11			
AEM90-AP11-D32-M16-L35-Z04-H	●	32	4	29	M16	35	17	11			
AEM90-AP11-D40-M16-L43-Z05-H	●	40	5	29	M16	43	17	11			

R: Sağ / Right / Rechts/ L: Sol / Left / Links

● Stokta / In Stock / Auf Lager ○ Stokta Yok / Non Stock Item / Kein Lagerartikel, Lieferzeit auf Anfrage

ZCC Ucuna Uygundur. / Compatible with ZCC Insert. / Kompatibel mit ZCC Wendeplatten.

Sipariş Örneği/Ordering Example/Bestellbeispiel



1 ad./pcs./stück AEM90-AP11-D16-M08-L30-Z02-H

Kesme Hesabı : S 429 / Cutting Calculation : P 429 / Schnittberechnung : P 429

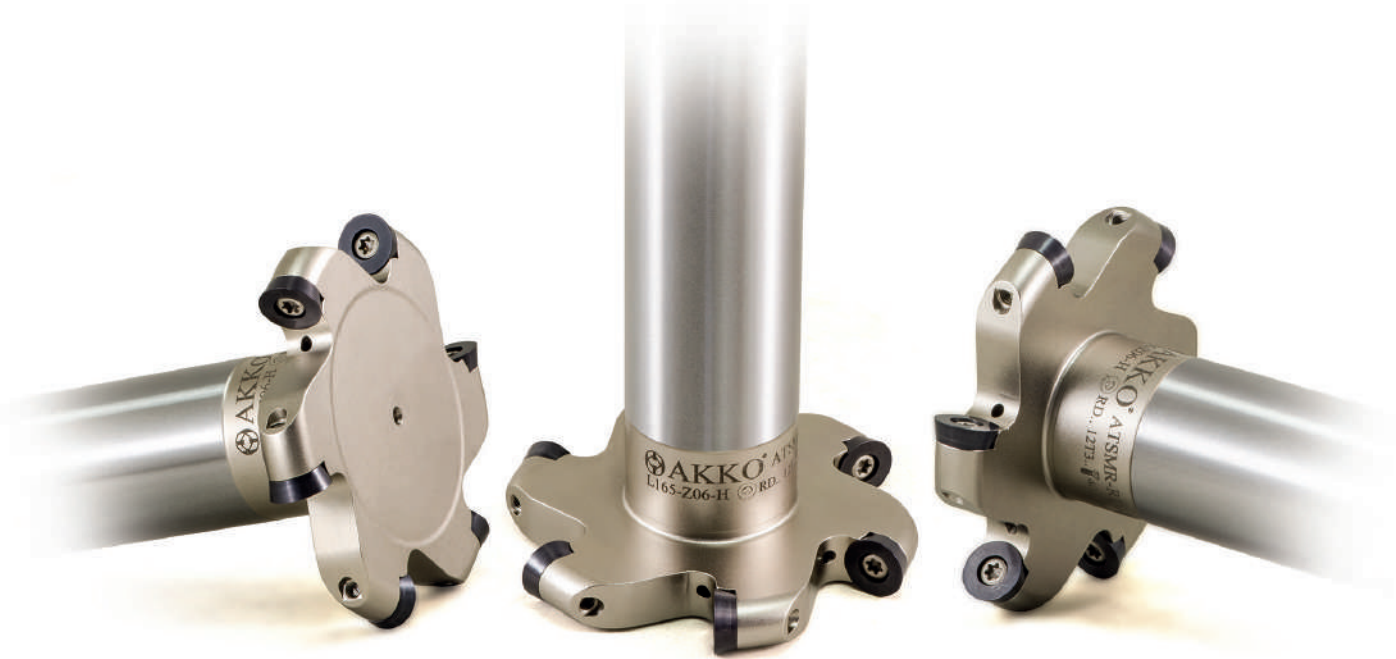
Sıkma Tork Değeri : S 428 / Tightening Torque : P 428 / Anzugsmoment : P 428

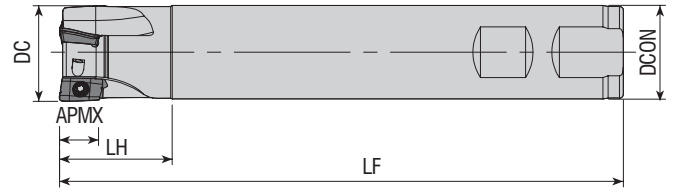

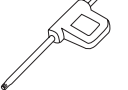

Takım Kodu Ordering Code Bestell-Bezeichnung	Stok Stock Lager	Takım Ölçüleri (mm) Dimension (mm) Abmessung (mm)						Kesici Uç Insert Wendeschneidplatte	Yedek Parçaları / Spare Parts / Ersatzteile		
		DC	ZEFP	DCON	LF	LH	APMX		Sıkma Vidası Screw Schraube	Tork Anahtar Torx Key Torx-Schlüssel	
AEM90-AZ11-D12-W16-L90-Z01	●	12	1	16	90	30	11				
AEM90-AZ11-D16-C16-L200-Z02	●	16	2	16	200	100	11				
AEM90-AZ11-D16-W15-L170-Z02	●	16	2	15	170	50	11				
AEM90-AZ11-D16-W16-L100-Z02	●	16	2	16	100	35	11				
AEM90-AZ11-D16-W16-L150-Z02	●	16	2	16	150	50	11				
AEM90-AZ11-D17-C16-L150-Z02	●	17	2	16	150	30	11				
AEM90-AZ11-D17-C16-L180-Z02	●	17	2	16	180	50	11				
AEM90-AZ11-D17-W16-L100-Z02	●	17	2	16	100	30	11				
AEM90-AZ11-D18-W16-L120-Z02	●	18	2	16	120	18	11				
AEM90-AZ11-D20-C20-L200-Z03	●	20	3	20	200	100	11		AZGT 1135..	3008-M2.5X6	82-T08
AEM90-AZ11-D20-W19-L170-Z03	●	20	3	19	170	50	11				
AEM90-AZ11-D20-W20-L110-Z02	●	20	2	20	110	35	11				
AEM90-AZ11-D21-C20-L150-Z03	●	21	3	20	150	30	11				
AEM90-AZ11-D21-C20-L180-Z03	●	21	3	20	180	50	11				
AEM90-AZ11-D21-W20-L110-Z03	●	21	3	20	110	35	11				
AEM90-AZ11-D22-C20-L150-Z02	●	22	2	20	150	30	11				
AEM90-AZ11-D25-C24-L180-Z04	●	25	4	24	180	50	11				
AEM90-AZ11-D25-W25-L110-Z04	●	25	4	25	110	40	11				
AEM90-AZ11-D26-C25-L250-Z02	●	26	2	25	250	50	11				
AEM90-AZ11-D26-W25-L120-Z03	●	26	3	25	120	30	11				
AEM90-AZ11-D26-W25-L120-Z04	●	26	4	25	120	40	11				
AEM90-AZ11-D28-C25-L180-Z03	●	28	3	25	180	50	11				
AEM90-AZ11-D28-C25-L250-Z02	●	28	2	25	250	50	11				
AEM90-AZ11-D33-W32-L130-Z04	●	33	4	32	130	50	11				

R: Sağ / Right / Rechts/ L: Sol / Left / Links

● Stokta / In Stock / Auf Lager ○ Stokta Yok / Non Stock Item / Kein Lagerartikel, Lieferzeit auf Anfrage

ZCC Ucuna Uygundur. / Compatible with ZCC Insert. / Kompatibel mit ZCC Wendeplatten.

Sipariş Örneği/Ordering Example/Bestellbeispiel

1 ad./pcs./stück AEM90-AZ11-D12-W16-L90-Z01

Kesme Hesabı : S 429 / Cutting Calculation : P 429 / Schnittberechnung : P 429

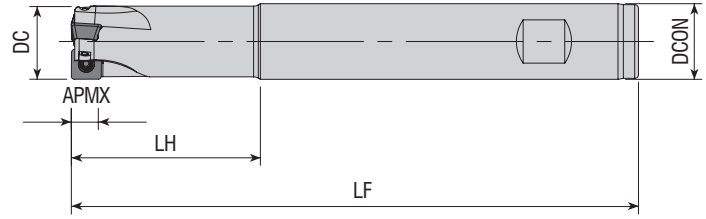

Takım Kodu Ordering Code Bestell-Bezeichnung	Stok Stock Lager	Takım Ölçüleri (mm) Dimension (mm) Abmessung (mm)						Kesici Uç Insert Wendeschneidplatte	Yedek Parçaları / Spare Parts / Ersatzteile	
		DC	ZEFP	DCON	LF	LH	APMX		Sıkma Vidası Screw Schraube	Tork Anahtar Torx Key Torx-Schlüssel
AEM90-SPGT0602-D16-W16-L150-Z02	●	16	2	16	150	50	5.5			
AEM90-SPGT07T3-D20-W20-L150-Z03	●	20	3	20	150	50	7			
AEM90-SPGT07T3-D25-W25-L150-Z03	●	25	3	25	150	50	7			
AEM90-SPGT0904-D30-W32-L150-Z03	●	30	3	32	150	50	9			

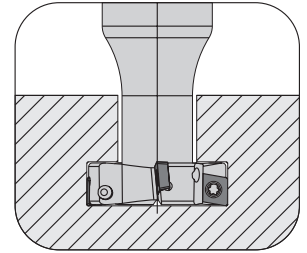
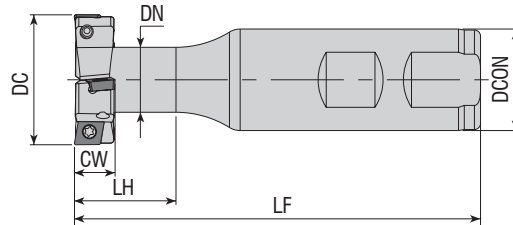

Takım Kodu Ordering Code Bestell-Bezeichnung	Stok Stock Lager	Takım Ölçüleri (mm) Dimension (mm) Abmessung (mm)								Kesici Uç Insert Wendeschneidplatte	Yedek Parçaları / Spare Parts / Ersatzteile		
		ZEFP		DC	CW	DCON	LF	DN	LH				
		Toplam Total Gesamt	Etikli Effective Effektiv										
ATSM90-SPGT0502-D63X6-W32-L125-Z10	●	10	5	63	6	32	125	31	30				
ATSM90-SPGT0904-D32X14-W32-L120-Z04-H	●	4	2	32	14	32	120	17.5	30				
ATSM90-SPGT0904-D37X16-W32-L120-Z04-H	●	4	2	37	16	32	120	21	40				
ATSM90-SPGT0904-D42X17-W32-L120-Z04-H	●	4	2	42	17	32	120	21	40				
ATSM90-SPGT1104-D47X20-W32-L120-Z04-H	●	4	2	47	20	32	120	24	45				

R: Sağ / Right / Rechts L: Sol / Left / Links

● Stokta / In Stock / Auf Lager ○ Stokta Yok / Non Stock Item / Kein Lagerartikel, Lieferzeit auf Anfrage

ZCC Ucuna Uygundur. / Compatible with ZCC Insert. / Kompatibel mit ZCC Wendeplatten.

Sipariş Örneği/Ordering Example/Bestellbeispiel
1 ad./pcs./stück AEM90-SPGT0602-D16-W16-L150-Z02
Kesme Hesabı : S 429 / Cutting Calculation : P 429 / Schnittberechnung : P 429

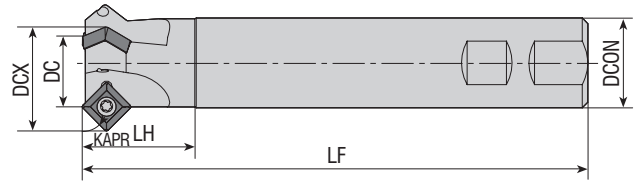

Takım Kodu Ordering Code Bestell-Bezeichnung	Stok Stock Lager	Takım Ölçüleri (mm) Dimension (mm) Abmessung (mm)								Kesici Uç Insert Wendeschneidplatte	Yedek Parçaları / Spare Parts / Ersatzteile	
		KAPR	DC	DCX	DCON	LF	LH	ZEFP	a		Sıkma Vidası Screw Schraube	Tork Anahtar Torx Key Torx-Schlüssel
ACM45-SP1104-D12x26-W20-L150-Z01	●	45°	12	26	20	150	30	1	-	SPGT 110408	4015-M4x9	80-T15
ACM45-SP1104-D25x39-W25-L150-Z02	●	45°	25	39	25	150	35	2	-			
ACM45-SP1104-D32x46-W32-L150-Z03	●	45°	32	46	32	150	40	3	-			

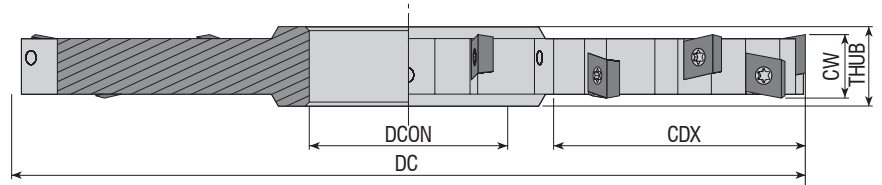

Takım Kodu Ordering Code Bestell-Bezeichnung	Stok Stock Lager	Takım Ölçüleri (mm) Dimension (mm) Abmessung (mm)							Kesici Uç Insert Wendeschneidplatte	Yedek Parçaları / Spare Parts / Ersatzteile	
		ZEFP		DC	CW	CDX	DCON	THUB		Sıkma Vidası Screw Schraube	Tork Anahtar Torx Key Torx-Schlüssel
		Toplam Total Gesamt	Etkili Effective Effektiv								
ASDM-SPGT05-D80x6-d27-Z10	●	10	5	80	6	17	27	10	SPGT 050204	3006-M2x4	82-T06
ASDM-SPGT05-D100x6-d32-Z12	●	12	6	100	6	25	32	10			
ASDM-SPGT05-D125x6-d40-Z14	●	14	7	125	6	35	40	10			
ASDM-SPGT05-D160x6-d40-Z18	●	18	9	160	6	52	40	10	SPGT 060204	3007-M2.2x4.6	82-T07
ASDM-SPGT06-D80x7-d27-Z10	●	10	5	80	7	17	27	11			
ASDM-SPGT06-D100x7-d32-Z12	●	12	6	100	7	25	32	11			
ASDM-SPGT06-D125x7-d40-Z14	●	14	7	125	7	35	40	11	SPGT 07T308	3008-M2.5x6	82-T08
ASDM-SPGT06-D160x7-d40-Z16	●	16	8	160	7	52	40	11			
ASDM-SPGT06-D200x7-d40-Z18	●	18	9	200	7	70	40	11			
ASDM-SPGT07-D100x10-d27-Z10	●	10	5	100	10	26.5	27	14	SPGT 07T308	3008-M2.5x6	82-T08
ASDM-SPGT07-D100x10-d32-Z12	●	12	6	100	10	25	32	11			

R: Sağ / Right / Rechts L: Sol / Left / Links

● Stokta / In Stock / Auf Lager ○ Stokta Yok / Non Stock Item / Kein Lagerartikel, Lieferzeit auf Anfrage

ZCC Ucuna Uygundur. / Compatible with ZCC Insert. / Kompatibel mit ZCC Wendeplatten.

Sipariş Örneği/Ordering Example/Bestellbeispiel

1 ad./pcs./stück ACM45-SP1104-D12x26-W20-L150-Z01

Kesme Hesabı : S 429 / Cutting Calculation : P 429 / Schnittberechnung : P 429

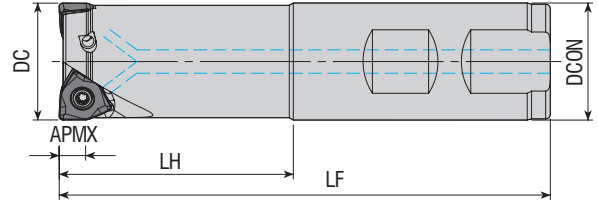

Takım Kodu Ordering Code Bestell-Bezeichnung	Stok Stock Lager	Takım Ölçüleri (mm) Dimension (mm) Abmessung (mm)						Kesici Uç Insert Wendeschneidplatte	Yedek Parçaları / Spare Parts / Ersatzteile		
		DC	ZEFP	DCON	LF	LH	APMX		Sıkma Vidası Screw Schraube	Tork Anahtar Torx Key Torx-Schlüssel	
AEM90L-WN0604Z-D25-C25-L200-Z02-H	●	25	2	25	200	100	5.7	WNHU 0604..	3008-M3x8	82-T08	
AEM90-WN0604Z-D25-W25-L150-Z02-H	●	25	2	25	150	50	5.7				
AEM90-WN0604Z-D32-W32-L150-Z03-H	●	32	3	32	150	50	5.7				
AEM90-WN0604Z-D40-W32-L150-Z04-H	●	40	4	32	150	35	5.7				

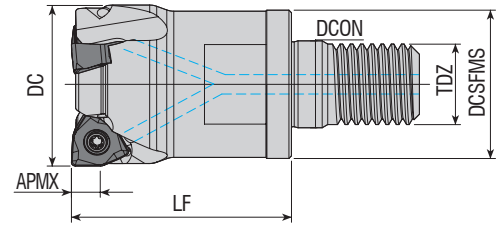

Takım Kodu Ordering Code Bestell-Bezeichnung	Stok Stock Lager	Takım Ölçüleri (mm) Dimension (mm) Abmessung (mm)							Kesici Uç Insert Wendeschneidplatte	Yedek Parçaları / Spare Parts / Ersatzteile		
		DC	ZEFP	DCSFMS	TDZ	LF	DCON	APMX		Sıkma Vidası Screw Schraube	Tork Anahtar Torx Key Torx-Schlüssel	
AEM90-WN0604Z-D25-M12-L35-Z02-H	●	25	2	21	M12	35	12.5	5.7	WNHU 0604..	3008-M3x8	82-T08	
AEM90-WN0604Z-D32-M16-L43-Z03-H	●	32	3	29	M16	43	17	5.7				
AEM90-WN0604Z-D40-M16-L43-Z04-H	●	40	4	29	M16	43	17	5.7				

R: Sağ / Right / Rechtsl L: Sol / Left / Links

● Stokta / In Stock / Auf Lager ○ Stokta Yok / Non Stock Item / Kein Lagerartikel, Lieferzeit auf Anfrage

ZCC Ucuna Uygundur. / Compatible with ZCC Insert. / Kompatibel mit ZCC Wendeplatten.

Sipariş Örneği/Ordering Example/Bestellbeispiel

1 ad./pcs./stück AEM90L-WN0604Z-D25-C25-L200-Z02-H

Kesme Hesabı : S 429 / Cutting Calculation : P 429 / Schnittberechnung : P 429

Sıkma Tork Değeri : S 428 / Tightening Torque : P 428 / Anzugsmoment : P 428

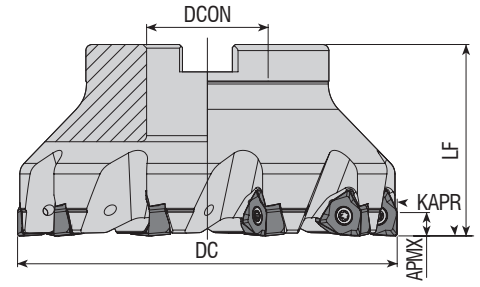

Takım Kodu Ordering Code Bestell-Bezeichnung	Stok Stock Lager	Takım Ölçüleri (mm) Dimension (mm) Abmessung (mm)					Kesici Uç Insert Wendeschneidplatte	Yedek Parçaları / Spare Parts / Ersatzteile		
		DC	ZEFP	DCON	LF	APMX		Sıkma Vidası Screw Schraube	Tork Anahtar Torx Key Torx-Schlüssel	Montaj Vidası Mounting Screw Befestigungsschraube
AFM90-WN0604Z-D040-A16-Z04-H	●	40	4	16	40	5.7	WNHU 0604..	3008-M3x8	82-T08	2506-M8x30
AFM90-WN0604Z-D050-A22-Z05-H	●	50	5	22	40	5.7				2508-M10x30
AFM90-WN0604Z-D063-A22-Z06-H	●	63	6	22	40	5.7				2510-M12x35
AFM90-WN0604Z-D080-A27-Z07-H	●	80	7	27	50	5.7				2514-M16x35
AFM90-WN0604Z-D100-A32-Z09-H	●	100	9	32	50	5.7				-
AFM90-WN0806Z-D050-A22-Z04-H	●	50	4	22	40	7.7	WNHU 0806..	4015-M4x11	80-T15	2508-M10x30
AFM90-WN0806Z-D063-A22-Z05-H	●	63	5	22	40	7.7				2510-M12x35
AFM90-WN0806Z-D080-A27-Z06-H	●	80	6	27	50	7.7				2514-M16x35
AFM90-WN0806Z-D100-A32-Z08-H	●	100	8	32	50	7.7				-
AFM90-WN0806Z-D125-B40-Z10	●	125	10	40	63	7.7				-
AFM90-WN0806Z-D160-C40-Z12	●	160	12	40	63	7.7	-	-	-	

R: Sağ / Right / Rechts/ L: Sol / Left / Links

● Stokta / In Stock / Auf Lager ○ Stokta Yok / Non Stock Item / Kein Lagerartikel, Lieferzeit auf Anfrage

ZCC Ucuna Uygundur. / Compatible with ZCC Insert. / Kompatibel mit ZCC Wendeplatten.

Sipariş Örneği/Ordering Example/Bestellbeispiel

1 ad./pcs./stück AFM90-WN0604Z-D040-A16-Z04-H

Kesme Hesabı : S 429 / Cutting Calculation : P 429 / Schnittberechnung : P 429



ZCC Ucuna Uygundur. / Compatible with ZCC Insert. / Kompatibel mit ZCC Wendeplatten.

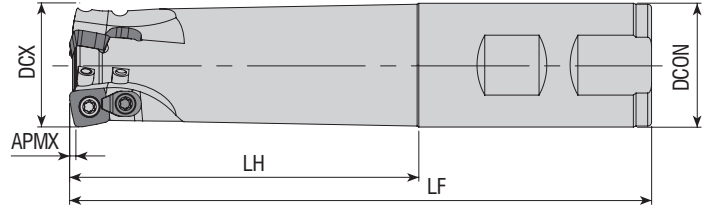

Takım Kodu Ordering Code Bestell-Bezeichnung	Stok Stock Lager	Takım Ölçüleri (mm) Dimension (mm) Abmessung (mm)						Kesici Uç Insert Wendeschneidplatte	Yedek Parçaları / Spare Parts / Ersatzteile			
		DCX	ZEFP	DCON	LF	LH	APMX		Sıkma Vidası Screw Schraube	Baskı Parçası Wedge Clamp Spannpratze	Baskı Vidası Clamp Screw Schraube	Tork Anahtar Torx Key Torx-Schlüssel
AHFM-SD06T2-D16-C16-L100-Z02-H	●	16	2	16	100	50	0.8	SD.. 06T2..	3007-M2.2x4.6	-	-	82-T07
AHFM-SD06T2-D16-C16-L150-Z02-H	●	16	2	16	150	50	0.8					
AHFM-SD06T2-D16-C16-L200-Z02	●	16	2	16	200	100	0.8					
AHFM-SD06T2-D17-C16-L150-Z02-H	●	17	2	16	150	50	0.8					
AHFM-SD06T2-D20-C20-L150-Z03-H	●	20	3	20	150	50	0.8					
AHFM-SD06T2-D20-C20-L200-Z03	●	20	3	20	200	100	0.8					
AHFM-SD06T2-D21-C20-L150-Z03-H	●	21	3	20	150	50	0.8					
AHFM-SD06T2-D25-C25-L150-Z04-H	●	25	4	25	150	60	0.8					
AHFM-SD06T2-D26-C25-L150-Z04-H	●	26	4	25	150	60	0.8					
AHFMC-SD09T3-D22-W20-L150-Z02	●	22	2	20	150	30	1.4					
AHFMC-SD09T3-D25-C25-L150-Z02	●	25	2	25	150	94	1.4					
AHFMC-SD09T3-D25-W25-L150-Z02	●	25	2	25	150	94	1.4					
AHFMC-SD09T3-D28-C25-L150-Z02	●	28	2	25	150	30	1.4					
AHFMC-SD09T3-D32-C32-L150-Z03	●	32	3	32	150	100	1.4					
AHFMC-SD09T3-D32-W32-L150-Z03	●	32	3	32	150	90	1.4					
AHFMC-SD09T3-D25-C25-L150-Z03	●	25	3	25	150	60	1.4					
AHFMC-SD09T3-D32-C32-L150-Z04	●	32	4	25	150	60	1.4					

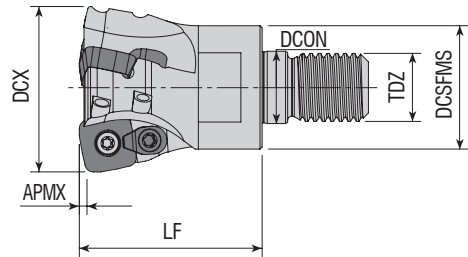

Takım Kodu Ordering Code Bestell-Bezeichnung	Stok Stock Lager	Takım Ölçüleri (mm) Dimension (mm) Abmessung (mm)							Kesici Uç Insert Wendeschneidplatte	Yedek Parçaları / Spare Parts / Ersatzteile			
		DCX	ZEFP	DCSFMS	TDZ	LF	DCON	APMX		Sıkma Vidası Screw Schraube	Baskı Parçası Wedge Clamp Spannpratze	Baskı Vidası Clamp Screw Schraube	Tork Anahtar Torx Key Torx-Schlüssel
AHFM-SD06T2-D16-M08-L23-Z02-H	●	16	2	14.75	M08	23	8.5	0.8	SD.. 06T2..	3007-M2.2x4.6	-	-	82-T07
AHFM-SD06T2-D20-M10-L30-Z03-H	●	20	3	18	M10	30	10.5	0.8					
AHFM-SD06T2-D25-M12-L35-Z04-H	●	25	4	21	M12	35	12.5	0.8					
AHFMC-SD09T3-D25-M12-L30-Z02-H	●	25	2	22	M12	30	12.5	1.4	SD.. 09T3..	3010-M3.5x9	ACK-15	1510-M3.5x9	82-T10
AHFMC-SD09T3-D32-M16-L43-Z03-H	●	32	3	29	M16	43	17	1.4					
AHFMC-SD09T3-D35-M16-L43-Z03-H	●	35	3	29	M16	43	17	1.4					
AHFMC-SD09T3-D40-M16-L43-Z04-H	●	40	4	29	M16	43	17	1.4					
AHFMC-SD1204-D32-M16-L43-Z02-H	●	32	2	29	M16	43	17	1.8					
AHFMC-SD1204-D40-M16-L43-Z03-H	●	40	3	29	M16	43	17	1.8	SD.. 1204..	4015-M4x9		4015-M3.5x11	80-T15

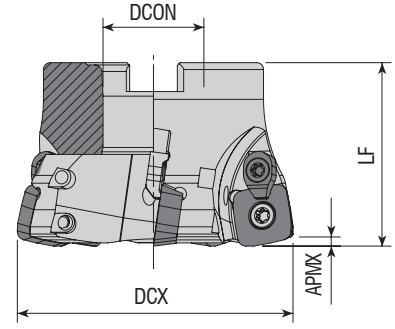
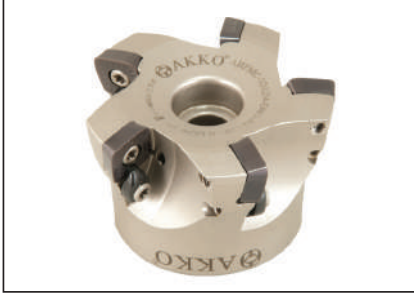

Takım Kodu Ordering Code Bestell-Bezeichnung	Stok Stock Lager	Takım Ölçüleri (mm) Dimension (mm) Abmessung (mm)					Kesici Uç Insert Wendeschneidplatte	Yedek Parçaları / Spare Parts / Ersatzteile				
		DCX	ZEPF	DCON	LF	APMX		Sıkma Vidası Screw Schraube	Baskı Pabucu Wedge Clamp Spannpratze	Baskı Vidası Clamp Screw Klemmschraube	Tork Anahtar Torx Key Torx-Schlüssel	Montaj Vidası Mounting Screw Befestigungsschraube
AHFMC-SD1204-D050-A22-Z04-H	●	50	4	22	40	1.8	SD.. 1204..		ACK-15	4015-M3.5x11	80-T15	
AHFMC-SD1204-D063-A22-Z05-H	●	63	5	22	40	1.8						
AHFMC-SD1204-D080-A27-Z06-H	●	80	6	27	50	1.8						
AHFMC-SD1204-D100-A32-Z08-H	●	100	8	32	50	1.8						

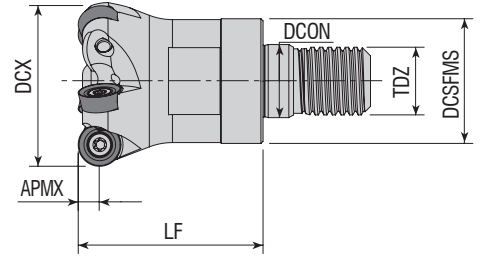

Takım Kodu Ordering Code Bestell-Bezeichnung	Stok Stock Lager	Takım Ölçüleri (mm) Dimension (mm) Abmessung (mm)							Kesici Uç Insert Wendeschneidplatte	Yedek Parçaları / Spare Parts / Ersatzteile	
		DCX	ZEPF	DCSFMS	TDZ	LF	DCON	APMX		Sıkma Vidası Screw Schraube	Tork Anahtar Torx Key Torx-Schlüssel
AEMR-RC10T3-D25-M12-L35-Z03-H	●	25	3	21	M12	35	12.5	5	RC.. 10T3..	4015-M4x9	80-T15
AEMR-RC10T3-D32-M16-L43-Z04-H	●	32	4	29	M16	43	17	5			
AEMR-RC10T3-D40-M16-L43-Z05-H	●	40	5	29	M16	43	17	5			

R: Sağ / Right / Rechts L: Sol / Left / Links

● Stokta / In Stock / Auf Lager ○ Stokta Yok / Non Stock Item / Kein Lagerartikel, Lieferzeit auf Anfrage

ZCC Ucuna Uygundur. / Compatible with ZCC Insert. / Kompatibel mit ZCC Wendeplatten.

Sipariş Örneği/Ordering Example/Bestellbeispiel

1 ad./pcs./stück AHFMC-SD1204-D050-A22-Z04-H

Kesme Hesabı : S 429 / Cutting Calculation : P 429 / Schnittberechnung : P 429

Sıkma Tork Değeri : S 428 / Tightening Torque : P 428 / Anzugsmoment : P 428

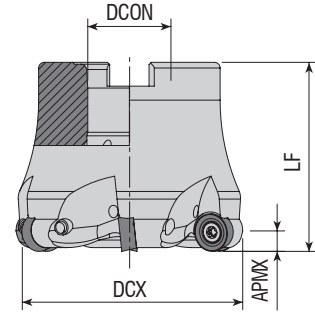

Takım Kodu Ordering Code Bestell-Bezeichnung	Stok Stock Lager	Takım Ölçüleri (mm) Dimension (mm) Abmessung (mm)					Kesici Uç Insert Wendeschneidplatte	Yedek Parçaları / Spare Parts / Ersatzteile		
		DCX	ZEPF	DCON	LF	APMX		Sıkma Vidası Screw Schraube	Tork Anahtar Torx Key Torx-Schlüssel	Montaj Vidası Mounting Screw Befestigungsschraube
AFMR-RC10T3-D040-A16-Z04-H	●	40	4	16	40	5	RC.. 10T3..	4015-M4x11	80-T15	2406-M8x30
AFMR-RC10T3-D050-A22-Z05-H	●	50	5	22	50	5				2508-M10x30
AFMR-RC10T3-D063-A22-Z06-H	●	63	6	22	50	5				

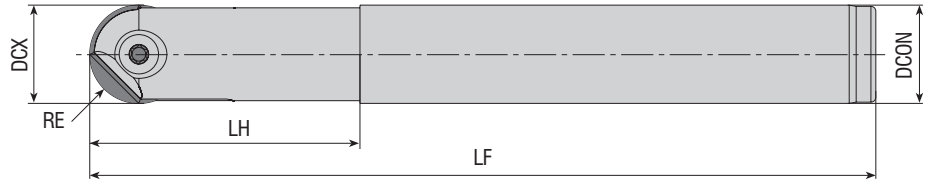

Takım Kodu Ordering Code Bestell-Bezeichnung	Stok Stock Lager	Takım Ölçüleri (mm) Dimension (mm) Abmessung (mm)					Kesici Uç Insert Wendeschneidplatte	Yedek Parçaları / Spare Parts / Ersatzteile	
		DCX	RE	DCON	LF	LH		Sıkma Vidası Screw Schraube	Tork Anahtar Torx Key Torx-Schlüssel
APMR-RO12-D12-C12-L120	●	12	6	12	120	35	ROHX 1203	1215-M4x0.5x9	80-T15
APMR-RO12-D12-C16-L160	●	12	6	16	160	50			
APMR-RO16-D16-C16-L160	●	16	8	16	160	45	ROHX 1604	1220-M5x0.5x12	80-T20
APMR-RO16-D16-C16-L200	●	16	8	16	200	45			
APMR-RO16-D16-C20-L200	●	16	8	20	200	65	ROHX 2005	1220-M5x0.5x15	
APMR-RO20-D20-C20-L160	●	20	10	20	160	55			
APMR-RO20-D20-C20-L200	●	20	10	20	200	55			
APMR-RO20-D20-C25-L220	●	20	10	25	220	80			

R: Sağ / Right / Rechts/ L: Sol / Left / Links

● Stokta / In Stock / Auf Lager ○ Stokta Yok / Non Stock Item / Kein Lagerartikel, Lieferzeit auf Anfrage

ZCC Ucuna Uygundur. / Compatible with ZCC Insert. / Kompatibel mit ZCC Wendeplatten.

Sipariş Örneği/Ordering Example/Bestellbeispiel





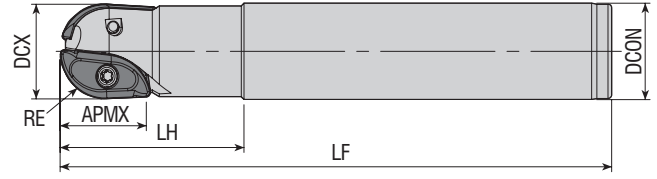

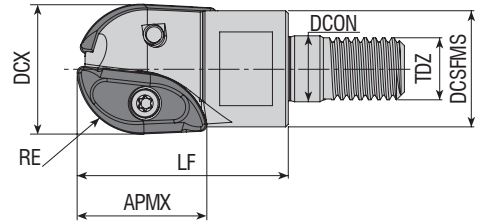

1 ad./pcs./stück AFMR-RC10T3-D040-A16-Z04-H

Kesme Hesabı : S 429 / Cutting Calculation : P 429 / Schnittberechnung : P 429

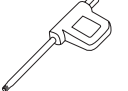

Takım Kodu Ordering Code Bestell-Bezeichnung	Stok Stock Lager	Takım Ölçüleri (mm) Dimension (mm) Abmessung (mm)						Kesici Uç Insert Wendeschneidplatte	Yedek Parçaları / Spare Parts / Ersatzteile		
		DCX	RE	DCON	LF	LH	APMX		Sıkma Vidası Screw Schraube	Tork Anahtar Torx Key Torx-Schlüssel	
APMR-XP16-D16-C16-L150	●	16	8	16	150	40	16				
APMR-XP20-D20-C20-L150	●	20	10	20	150	50	20				
APMR-XP25-D25-C25-L150	●	25	12.5	25	150	50	25				



Takım Kodu Ordering Code Bestell-Bezeichnung	Stok Stock Lager	Takım Ölçüleri (mm) Dimension (mm) Abmessung (mm)								Kesici Uç Insert Wendeschneidplatte	Yedek Parçaları / Spare Parts / Ersatzteile	
		DCX	RE	DCSFMS	TDZ	LF	APMX	DCON	Sıkma Vidası Screw Schraube		Tork Anahtar Torx Key Torx-Schlüssel	
APMR-XP16-D16-M08-L25	●	16	8	14.75	M08	25	16	8.5				
APMR-XP20-D20-M10-L30	●	20	10	18	M10	30	20	10.5				
APMR-XP25-D25-M12-L40	●	25	12.5	22	M12	40	25	12.5				

R: Sağ / Right / Rechts/ L: Sol / Left / Links

● Stokta / In Stock / Auf Lager ○ Stokta Yok / Non Stock Item / Kein Lagerartikel, Lieferzeit auf Anfrage

ZCC Ucuna Uygundur. / Compatible with ZCC Insert. / Kompatibel mit ZCC Wendeplatten.

Sipariş Örneği/Ordering Example/Bestellbeispiel

1 ad./pcs./stück APMR-XP16-D16-C16-L150

Kesme Hesabı : S 429 / Cutting Calculation : P 429 / Schnittberechnung : P 429

Sıkma Tork Değeri : S 428 / Tightening Torque : P 428 / Anzugsmoment : P 428

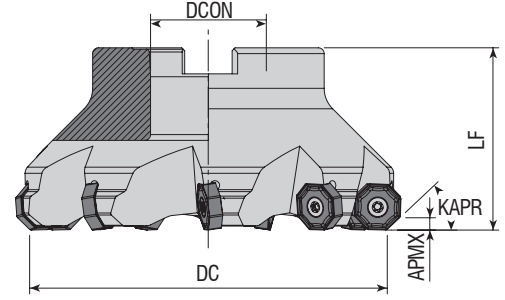

Takım Kodu Ordering Code Bestell-Bezeichnung	Stok Stock Lager	Takım Ölçüleri (mm) Dimension (mm) Abmessung (mm)					Kesici Uç Insert Wendeschneidplatte	Yedek Parçaları / Spare Parts / Ersatzteile		
		DC	ZEFP	DCON	LF	APMX		Sıkma Vidası Screw Schraube	Tork Anahtar Torx Key Torx-Schlüssel	Montaj Vidası Mounting Screw Befestigungsschraube
AFM43-ON0604-D050-A22-Z05-H	●	50	5	22	40	4	ON.. 0604..	4015-M4x11	80-T15	2407-M10x30
AFM43-ON0604-D063-A22-Z06-H	●	63	6	22	40	4				2510-M12x35
AFM43-ON0604-D080-A27-Z07-H	●	80	7	27	50	4				2514-M16x35
AFM43-ON0604-D100-A32-Z08-H	●	100	8	32	50	4				-
AFM43-ON0604-D125-B40-Z09	●	125	9	40	63	4				-

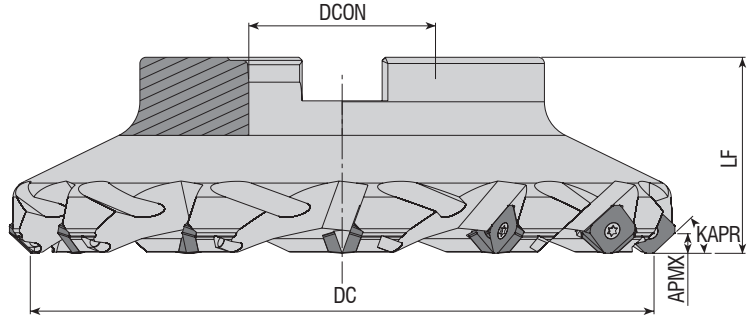

Takım Kodu Ordering Code Bestell-Bezeichnung	Stok Stock Lager	Takım Ölçüleri (mm) Dimension (mm) Abmessung (mm)					Kesici Uç Insert Wendeschneidplatte	Yedek Parçaları / Spare Parts / Ersatzteile		
		DC	ZEFP	DCON	LF	APMX		Sıkma Vidası Screw Schraube	Tork Anahtar Torx Key Torx-Schlüssel	Montaj Vidası Mounting Screw Befestigungsschraube
AFM45-SE12-D050-A22-Z04-H	●	50	4	22	40	6	SE.. 12T3.. R245-12T3..	4015-M3.5x11	80-T15	2407-M10x30
AFM45L-SE12-D050-A22-Z04-H	●	50	4	22	40	6				2510-M12x35
AFM45-SE12-D063-A22-Z05-H	●	63	5	22	40	6				2514-M16x35
AFM45L-SE12-D063-A22-Z05-H	●	63	5	22	40	6				-
AFM45-SE12-D080-A27-Z06-H	●	80	6	27	50	6				-
AFM45L-SE12-D080-A27-Z06-H	●	80	6	27	50	6				-
AFM45-SE12-D100-A32-Z07-H	●	100	7	32	50	6				-
AFM45-SE12-D125-B40-Z08	●	125	8	40	63	6				-
AFM45-SE12-D160-C40-Z10	●	160	10	40	63	6				-
AFM45L-SE12-D160-C40-Z10	●	160	10	40	63	6				-
AFM45-SE12-D200-C60-Z12	●	200	12	60	63	6				-

R: Sağ / Right / Rechts / L: Sol / Left / Links
● Stokta / In Stock / Auf Lager ○ Stokta Yok / Non Stock Item / Kein Lagerartikel, Lieferzeit auf Anfrage
ZCC Ucuna Uygun. / Compatible with ZCC Insert. / Kompatibel mit ZCC Wendeplatten.

Sipariş Örneği/Ordering Example/Bestellbeispiel
1 ad./pcs./stück AFM43-ON0604-D050-A22-Z05-H
Kesme Hesabı : S 429 / Cutting Calculation : P 429 / Schnittberechnung : P 429
Montaj Ölçüleri : S 426 / Mounting Reference : P 426 / Montagehinweis : P 426

KAPR=45°

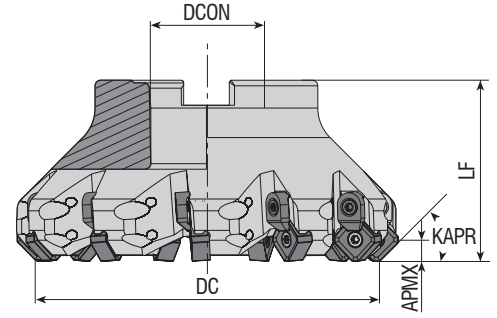
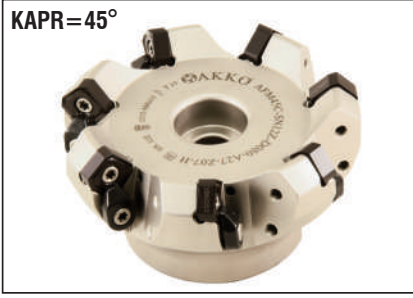

Takım Kodu Ordering Code Bestell-Bezeichnung	Stok Stock Lager	Takım Ölçüleri (mm) Dimension (mm) Abmessung (mm)					Kesici Uç Insert Wendeschneidplatte	Yedek Parçaları / Spare Parts / Ersatzteile				
		DC	ZEFP	DCON	LF	APMX		Sıkma Vidası Screw Schraube	Baskı Parçası Wedge Clamp Spannpratze	Baskı Vidası Clamp Screw Klemmschraube	Tork Anahtar Torx Key Torx-Schlüssel	Montaj Vidası Mounting Screw Befestigungsschraube
AFM45C-SN12Z-D050-A22-Z05-H	●	50	5	22	42	6	SNEG 1205..	4015-M4x11	ACK-05	4015-M4x11	80-T15	2407-M10X30
AFM45C-SN12Z-D063-A22-Z06-H	●	63	6	22	42	6						
AFM45C-SN12Z-D080-A27-Z07-H	●	80	7	27	52	6						
AFM45C-SN12Z-D100-A32-Z09-H	●	100	9	32	52	6						
AFM45C-SN12Z-D125-B40-Z11	●	125	11	40	65	6						
AFM45C-SN12Z-D160-C40-Z12	●	160	12	60	65	6						
AFM45C-SN12Z-D200-C60-Z14	●	200	14	60	65	6	-					



KAPR=88°

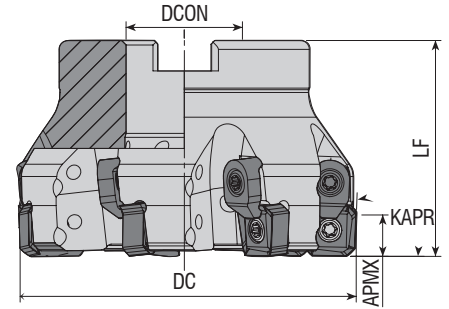

Takım Kodu Ordering Code Bestell-Bezeichnung	Stok Stock Lager	Takım Ölçüleri (mm) Dimension (mm) Abmessung (mm)					Kesici Uç Insert Wendeschneidplatte	Yedek Parçaları / Spare Parts / Ersatzteile				
		DC	ZEFP	DCON	LF	APMX		Sıkma Vidası Screw Schraube	Baskı Parçası Wedge Clamp Spannpratze	Baskı Vidası Clamp Screw Klemmschraube	Tork Anahtar Torx Key Torx-Schlüssel	Montaj Vidası Mounting Screw Befestigungsschraube
AFM88C-SN12Z-D063-A22-Z06-H	●	63	6	22	40	11.5	SNEG 1205..	4015-M4x11	ACK-05	4015-M4X11	80-T15	2508-M10x30
AFM88C-SN12Z-D080-A27-Z07-H	●	80	7	27	50	11.5						

R: Sağ / Right / Rechts/ L: Sol / Left / Links

● Stokta / In Stock / Auf Lager ○ Stokta Yok / Non Stock Item / Kein Lagerartikel, Lieferzeit auf Anfrage

ZCC Ucuna Uygundur. / Compatible with ZCC Insert. / Kompatibel mit ZCC Wendeplatten.

Sipariş Örneği/Ordering Example/Bestellbeispiel

1 ad./pcs./stück AFM45C-SN12Z-D050-A22-Z05-H

Kesme Hesabı : S 429 / Cutting Calculation : P 429 / Schnittberechnung : P 429

Sıkma Tork Değeri : S 428 / Tightening Torque : P 428 / Anzugsmoment : P 428

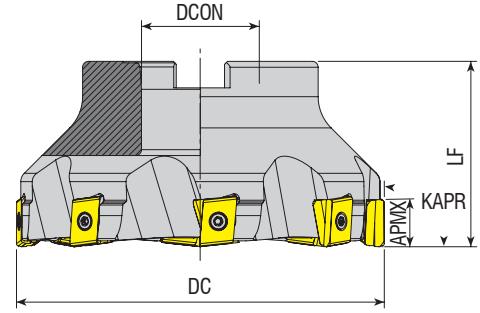

Takım Kodu Ordering Code Bestell-Bezeichnung	Stok Stock Lager	Takım Ölçüleri (mm) Dimension (mm) Abmessung (mm)					Kesici Uç Insert Wendeschneidplatte	Yedek Parçaları / Spare Parts / Ersatzteile			
		DC	ZEPF	DCON	LF	APMX		Sıkma Vidası Screw Schraube	Tork Anahtar Torx Key Torx-Schlüssel	Montaj Vidası Mounting Screw Befestigungsschraube	
AFM90-LN15Z-D050-A22-Z04	●	50	4	22	40	15	LNKT 1506..				
AFM90-LN15Z-D063-A22-Z05	●	63	5	22	40	15					2508-M10x30
AFM90-LN15Z-D080-A27-Z06	●	80	6	27	50	15					2510-M12x35
AFM90-LN15Z-D100-A32-Z07	●	100	7	32	50	15					2514-M16x35
AFM90-LN15Z-D125-B40-Z08	●	125	8	40	63	15					-

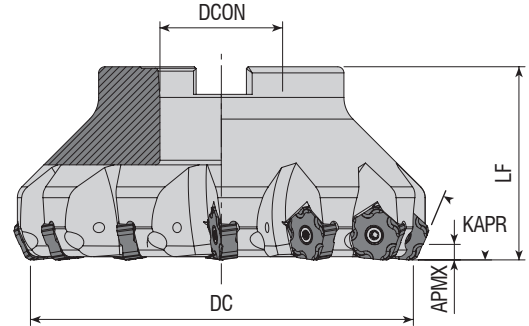

Takım Kodu Ordering Code Bestell-Bezeichnung	Stok Stock Lager	Takım Ölçüleri (mm) Dimension (mm) Abmessung (mm)					Kesici Uç Insert Wendeschneidplatte	Yedek Parçaları / Spare Parts / Ersatzteile			
		DC	ZEPF	DCON	LF	APMX		Sıkma Vidası Screw Schraube	Tork Anahtar Torx Key Torx-Schlüssel	Montaj Vidası Mounting Screw Befestigungsschraube	
AFM67-PN1105-D050-A22-Z05	●	50	5	22	50	5	PNEG 1105..				
AFM67-PN1105-D063-A22-Z06	●	63	6	22	50	5					2508-M10x30
AFM67-PN1105-D080-A27-Z08	●	80	8	27	50	5					2510-M12x35
AFM67-PN1105-D100-B32-Z10	●	100	10	32	50	5					-
AFM67-PN1105-D125-B40-Z12	●	125	12	40	63	5					-
AFM67-PN1105-D160-C40-Z14	●	160	14	40	63	5	-				

R: Sağ / Right / Rechts/ L: Sol / Left / Links
● Stokta / In Stock / Auf Lager ○ Stokta Yok / Non Stock Item / Kein Lagerartikel, Lieferzeit auf Anfrage
ZCC Ucuna Uygun. / Compatible with ZCC Insert. / Kompatibel mit ZCC Wendeplatten.

Sipariş Örneği/Ordering Example/Bestellbeispiel
1 ad./pcs./stück AFM90-LN15Z-D050-A22-Z04
Kesme Hesabı : S 429 / Cutting Calculation : P 429 / Schnittberechnung : P 429

A TIP / A TYPE / A-Typ

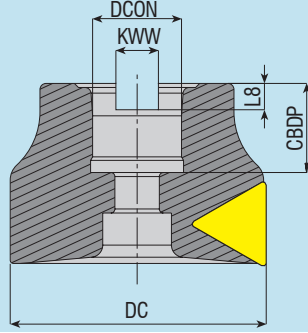

DC	DCON	DBC	KWW	L8	CBDP
40	16	-	8.4	5.6	20
50	22	-	10.4	6.3	22
63	22	-	10.4	6.3	22
80	27	-	12.4	7	25
100	32	-	14.4	8	26

B TIP / B TYPE / B-Typ

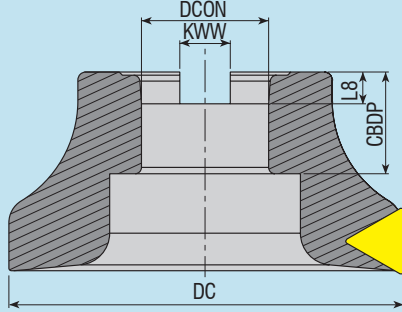

DC	DCON	DBC	KWW	L8	CBDP
125	40	-	16.4	9	32

C TIP / C TYPE / C-Typ

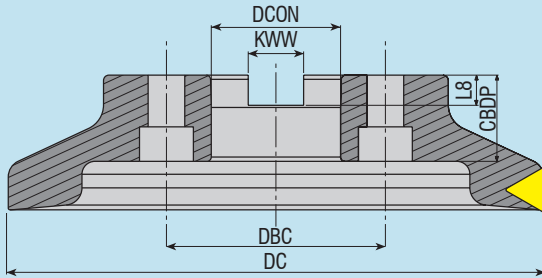

DC	DCON	DBC	KWW	L8	CBDP
160	40	66.7	16.4	9	32
200	60	101.6	25.7	14	40
250	60	101.6	25.7	14	40

D TIP / D TYPE / D-Typ

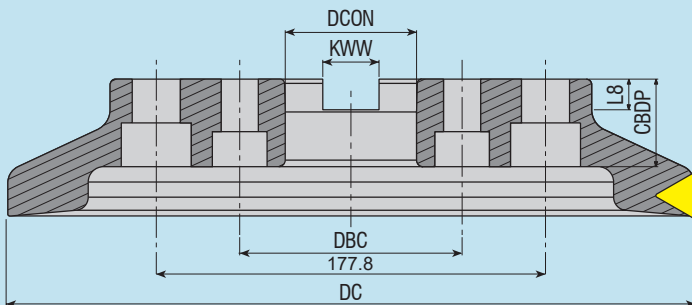

DC	DCON	DBC	KWW	L8	CBDP
315	60	101.6	25.7	14	40

TAKMA UÇLU MATKAP (U-DRILL) KULLANMA KILAVUZU

Matkabınızı CNC torna tezgahına bağlamadan önce taretin merkezden kaçık olup olmadığını kontrol etmeniz gerekir. Şayet taretinizde kaçıklık varsa, takma uçlu matkabınızı kesinlikle kullanmayınız. Taretin düzeltilmesi için yapılması gereken işlemler ;

1. Taretin tutucusuna kullanacağınız takma uçlu matkabın çapında ve boyunda üzeri hassas olan silindirik bir parça bağlanır ve tezgahın X değeri sıfıra getirilir.
2. Tezgahın aynasına mıknatıslı komprotör saati yerleştirilir. Saatin uç kısmı tarete bağlanmış olduğumuz parçanın üstüne temas ettirilir.
3. Aynanın üzerine bağlanmış olduğumuz mıknatıslı komprotör ayna ile beraber 360 derece döndürülerek saatteki değişim oranına göre taretin sıfırlanması sağlanır.

TAKMA UÇLU MATKABINIZI CNC TORNANIZDA DAHA VERİMLİ KULLANMANIZ İÇİN GEREKLİ OLAN KESME HIZLARI ve DEVİRLERİ :

Grup No.	Malzemenin Cinsi	Malzemenin Öz.	Kesme Hızı Vc (m/dk)
1	Çok Yumuşak İş Çelikleri	C1010, Otomat vb.	220
2	İmalat Çelik ve Döküm Malz.	C1030 - 106 vb.	200
3	Takım ve İmalat Çeşitleri	CK-45, 4140, 7131 vb.	170
4	Sıcak İş ve Paslanmaz Çelikler	İmpaks vb.	150

Devir hesabı yapabilmek için önce malzemeyi seçiniz. Seçtiğiniz malzemenin kesme hızını (Vc) 1000 ile çarpıp 3.14'e bölmeliyiz. Çıkan değeri matkap çapına bölmeliyiz. **ÖRNEK** : Malzememiz takım ve imalat çeliği (3. grup), matkap çapı 25 mm kesme hızı 170 ise $170 \times 1000 = 170000 / 3.14 = 54140$, $54140 / 25 = 2166$ devir çıkar (Tezgahın İş Mili Devri). Tezgahın ilerlemesi kullanacağınız uç ile de alakalı olup 0.05 ile 0.10 arasında değişim gösterir. Kullanıcı kesici ucun kesişine göre bunu ayarlar.

İŞLEME MERKEZLERİ İÇİN İLERLEME HESABI :

Yukarıdaki hesaplamalarla bulmuş olduğunuz 2166 iş mili devrini, kesici uç ilerlemesi (mm/devir) 0.05 ile 0.10 arasındaki ilerleme seçenekleri ile çarpılır. **ÖRNEK 1** : $2166 \times 0.05 = 108$ **ÖRNEK 2** : $2166 \times 0.10 = 217$ çıkan sonuçlar 108 ve 217 işleme merkezleri için ilerleme mm/dakika hesabıdır.

Not: D4 ve üzeri takma uçlu matkaplarda tezgahın içten su verme basıncının en az 6 bar olması gerekmektedir.

USER'S GUIDE FOR AKKO U-DRILLS

Before connecting your U-Drill to CNC lathe, you have to check if the turret is eccentric from the center or not. If there is any eccentricity in your turret, never use your U-Drill;

Processes that should be done to fix the turret :

1. A cylindrical part whose surface is precision and whose length and diameter is the same with the U-Drill that you will use, should be mounted to the holder of turret and X value of the lathe should be brought to zero (0).
2. Comparator should be mounted to chuck. The end of the comparator should be contacted (touched) to the surface of the part that we mounted on the turret.
3. The comparator that we mounted on the chuck should be turned 360-degree with the chuck and turret should be zeroed by that turning according to changing rate of comparator.

CUTTING SPEED AND REVOLUTION THAT ARE NEEDED FOR USING (RUNNING) YOUR U-DRILLS MORE PRODUCTIVELY

Grup No.	Material	Material Type	Cutting Speed Vc (m/m)
1	Non-alloy steel and free cutting steel	C1010. Automat etc.	220
2	Low alloy steel and cast steel	C1030 - 106 etc.	200
3	Alloy steel and tool steel	CK-45, 4140, 7131 etc.	170
4	Hot Work Steel and Stainless Steel	Impax etc.	150

P.S. : The cutting speed may be concerned with the type of the insert that you use.

Fistly, choose the material to make calculation of revolution. You should multiply the cutting speed (Vc) of the material that you chose by 1000 and divide by 3.14. You should divide the value that you found by the diameter of U-Drill. For Example : If our material is alloy steel and tool steel (3rd group), diameter of the U-Drill is 25 mm, cutting speed is 170, we should calculate as following; $170 \times 1000 = 170000 / 3.14 = 54140$, $54140 / 25 = 2166$ rpm is the result that we found (Spindle Speed) Feed rate of the lathe is concerned with the U-Drill that you will use and changes between 0.05 and 0.10. The user sets it according to cut of cutting insert.

FEED CALCULATION FOR CENTRAL MACHINE :

2166 spindle speed, that we found as a result of above mentioned calculation, should be multiplied by cutting insert feed (mm/r) between 0.05 and 0.10 feed choisses. Example 1 : $2166 \times 0.05 = 108$

Example 2 : $2166 \times 0.10 = 217$ The results 108 and 217 are the feed mm/m calculation for central machine.

Note: Cooling water pressure of lathe must be minimum 6 bar for our D4 u-drills and u-drills longer than D4.

GEBRAUCHSANLEITUNG FÜR AKKO-VOLLBOHRER

Bevor Sie den Vollbohrer auf die Drehmaschine montieren, prüfen Sie bitte ob der Revolverkopf zentrisch sitzt. Sollte der Revolverkopf aus der Mitte stehen, benutzen Sie den Vollbohrer bitte nicht. Auf folgende Weise können Sie den Revolverkopf zentrieren:

1. Setzen Sie ein präzises Drehteil, das die gleiche Länge und den gleichen Durchmesser hat wie der eingesetzte Vollbohrer, in den Halter vom Revolverkopf und justieren Sie den X-Wert der Drehmaschine auf null.
2. Setzen Sie bitte einen Messtaster in das Spannfutter ein. Der Fühler des Messtasters sollte mit der Oberfläche des Präzisionsteils im Revolver Kontakt haben.
3. Drehen Sie nun das Spannfutter mit dem Messtaster um 360°. Die angezeigte Abweichung zwischen Futter und Revolver sollte null betragen.

SCHNITTGESCHWINDIGKEIT UND DREHZAHL UM DIE VOLLBOHRER WIRTSCHAFTLICH EINZUSETZEN

Hauptgruppe	Hauptgruppe	Materialbezeichnung	Schnittgeschwindigkeit vc (m/min.)
1	Nicht Legierter Stahl und Automatenstahl	C1010. Automatenstahl	220
2	Niedrig Legierter Stahl und Stahlguss	C1030 - 106 vb.	200
3	Legierter Stahl und Werkzeugstahl	CK-45, 4140, 7131 vb.	170
4	Warmarbeitsstahl und Rostfreier Stahl	Impax und weitere Chrom-Nickel-Stähle	150

P.S.: Die genaue Schnittgeschwindigkeit hängt von der verwendeten Wendeschneidplatte ab.

In Abhängigkeit vom Material wählen Sie die Schnittgeschwindigkeit vc. Diesen Wert multiplizieren Sie mit 1000 und teilen ihn durch 3,14 und den Durchmesser des Werkzeugs (in mm).

Beispiel: Rostfreier Stahl (Hauptgruppe 3), Werkzeugdurchmesser 25 mm, Schnittgeschwindigkeit vc=170 m/min. Die Berechnung sieht wie folgt aus: $170 \times 1000 = 170000 / 3,14 = 54140 / 25 = 2166$ U/min. (Spindeldrehzahl). Der Vorschub der Maschine hängt vom Vollbohrer und der verwendeten Wendeschneidplatte ab und variiert zwischen 0,05 mm und 0,1 mm / Umdrehung.

VORSCHRUBBERECHNUNG :

Die oben berechnete Spindeldrehzahl von 2166 wird mit dem Vorschub 0,05 mm und 0,1 mm multipliziert. $2166 \text{ Umdr./min.} \times 0,05 \text{ mm/Umdr.} = 108 \text{ mm/min.}$ $2166 \text{ Umdr./min.} \times 0,1 \text{ mm/Umdr.} = 216 \text{ mm/min.}$ D.h. der Vorschub liegt zwischen 108 mm/min. und 216 mm/min. Hinweis: Der Kühlmitteldruck muss mindestens 6 bar betragen für die Vollbohrer mit $\geq 4 \times D$

SIKMA TORKU TAVSİYELERİ - RECOMMENDED TIGHTENING TORQUE EMPFÖHLENES ANZUGSMOMENT

- Takımı Sıkmadan Önce Aşağıdaki Bilgileri Okuyunuz.
Read below information before tightening the tool.
Bitte lesen Sie die nachfolgenden Informationen bevor Sie das Werkzeug spannen.
- Vidalı Takımın Vida Ölçüsü ile Tutucunun İç Vida Ölçüsünü Sıkmadan Önce Kontrol Ediniz.
Check screw set's the screw size and together with mounting arbor inner dimension of screws.
Prüfen Sie, ob das Gewinde vom Werkzeug mit dem Gewinde in der Verlängerung identisch ist.
- Takımı Tutucuya Sıkarken Tablodaki İlgili Değerlere Göre İşlem Yapınız.
When tightening head to an arbor, follow the related tightening torque in the table.
Wenn Sie den Einschraubfräser festziehen, beachten Sie bitte die angegebenen Anzugsmomente.

Vida Screw Schraube	Tork Torque (N.m) Anzugsmoment (N.m)
M6	8
M8	23
M10	46
M12	80
M16	90

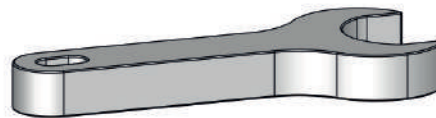

FREZELEME İŞLEMİNDE DEVİR ve İLERLEME HESABI

Vc.	S	D	F	Z	fz	FORMÜLLER
Kesme Hızı (Uç Kutusunun Arkasından Okuyunuz)	İş Mili Devir Sayısı	Tarama Kafası Çapı	İlerleme	Tarama Kafası Ağız Sayısı	Diş Başına Düşen İlerleme Miktarı (Uç Kutusunun Arkasından Okuyunuz)	Devir Hesabı : $S=(Vc \times 1000) / (3,14 \times D)$ İlerleme Hesabı : $F=S \times Z \times fz$

Örnek : D=50 mm çapında, Z=5 ağızlı tarama kafası ile frezeleme yapacağız. Kesici uç kutusunun arkasında kesme hızı Vc=200m/dk. olarak verilmiş olsun. Tezgaha girilecek devri hesaplayalım: **Vc=200 m/dk. D=50 mm S=** Öncelikle Kesme Hızı 1000 ile çarpılır, çıkan sonuç 3,14 sayısına bölünür, buradan çıkan sonuç da tarama kafası çapına bölünür.

$S=200 \times 1000 = 200000 \rightarrow 200000/3,14=63663 \rightarrow 63663/50=1273$ devir **S=1273 dev/dakika** devri bulduktan sonra ilerlemeyi bulalım: **Z=5** ağızlı tarama kafası olsun **fz=0,12** olarak uç kutusunun arkasından okunmuş olsun F= yukarıda bulmuş olduğumuz devir sayısı ile ağız sayısı çarpılır, çıkan sonuç diş başına düşen ilerleme miktarı ile çarpılır.

$F=1273 \times 5 = 6365 \rightarrow 6365 \times 0,12 = 763$ $F=763$ mm/dakika

Tezgaha girilecek olan devir = S 1273 Tezgaha girilecek olan ilerleme : **F 763 ortalama değerdir.**

Not: Vc ve fz değerlerinin uç kutusunun arkasında verilmiş olması gerekir. Eğer bu değerler uç kutusunun üzerinde yoksa, kesici ucun katalogundan bulunuz. İşleyeceğiniz malzeme çelik ise P, paslanmaz çelik ise M, dökme demir ise K bölümünde yazılı olan Vc ve fz değerlerini okuyun.

CALCULATING SPINDLE SPEED and FEED RATE FOR MILLING PROCESS

Vc.	S	D	F	Z	fz	FORMULAS
Cutting Speed (Please read from the back- side of cutting insert box)	Spindle Revolution rpm	Milling Tool Diameter	Feed Rate	Number of Effective Tooth	Feed Per Tooth (Please Read From The Back Side of Cutting Insert Box)	Calculation of Revolution : $S=(Vc \times 1000) / (3,14 \times D)$ Feed Rate Calculation : $F=S \times Z \times fz$

For Example : We will make milling with milling tool whose diameter is D 50 mm, whose teeth number is Z=5. The spindle revolution was written as Vc=200m/mn at the back side of cutting insert box. Let's calculate the revolution that should be entered to the milling machine : Vc=200 m/mn D=50 mm

S = Firstly Cutting Speed is multiplied with 1000, the result should be divided by 3.14 , the last result should be divided by diameter of milling tool.

$S = 200 \times 1000 = 200000 \rightarrow 200000/3,14 = 63663 \rightarrow 63663/50 = 1273$ rev $S=1273$ rev / mn

After finding spindle revolution, let's find feed rate : milling tool with Z=5 teeth and we read fz=0,12 from the back side of cutting insert box.

F = Tooth number should be multiplied with revolution, the result should be multiplied with feed per tooth.

$F = 1273 \times 5 = 6365 \rightarrow 6365 \times 0,12 = 763$ $F = 763$ mm / mn

Revolution that should be entered to the milling machine = S 1273 Feed Rate that should be entered to the milling machine = F 763 average value.

P.S : The values Vc and fz has to be written at the back side of the cutting insert. If these values were not written on the cutting insert box, please find them from cutting insert catalogue. If the material that you will work is steel, please read Vc and fz values that were written on the part P, if it is stainless steel please read from the part M, if it is cast iron please read from the part K.

BERECHNUNG VON DREHZAHL UND VORSCHUB FÜR FRÄSWERKZEUGE

Vc.	S	D	F	Z	fz	Formeln
Schnittgeschwindigkeit (finden Sie z.B. auf der Verpackung der Wendeschneidplatte)	Spindel Drehzahl	Fräswerkzeug Durchmesser	Vorschubgeschwindigkeit	Anzahl der effektiven Zähne	Vorschub pro Zahn (finden Sie z.B. auf der Verpackung der Wendeschneidplatte)	Berechnung der Drehzahl: $n=(vc \times 1000) / (3,14 \times D)$ Vorschubberechnung: $F=n \times Z \times fz$

Beispiel: Fräswerkzeug mit D=50 mm und Z=5. Schnittgeschwindigkeit vc=200 m/min. (laut Wendeschneidplattenverpackung).

Berechnung der Drehzahl: $n=200 \text{ m/min.} \times 1000 = 200000 / 3,14=63694 / 50 \text{ mm} = 1273$ Umdr./min.

Berechnung des Vorschubs: Ermittlung von fz (finden Sie z.B. auf der Verpackung der Wendeschneidplatte), für das Berechnungsbeispiel fz=0,12 mm F = n x Z x fz = 1273 x 5 x 0,12 = 763 mm/min. D.h., Sie stellen an der Maschine folgende Werte ein: Drehzahl n = 1273 Umdr./min., Vorschub F = 763 mm/min.

P.S.: Die Werte für vc und fz finden Sie auf der Rückseite der Wendeschneidplattenverpackung. Sollten diese Werte dort nicht stehen, können Sie diese auch im Wendeschneidplattenkatalog finden. Für Stahl wählen Sie für vc und fz bitte die Werte aus dem Bereich P, für rostfreien Stahl aus dem Bereich M und für Guss aus dem Bereich K.

Gövde Malzemesine Göre Delik İçi Kater Uygulama Kılavuzu

Internal Boring Bars Application Guide, Related to Body Material

Anwendungshinweise für Bohrstangen, abhängig vom Bohrstangen-Material

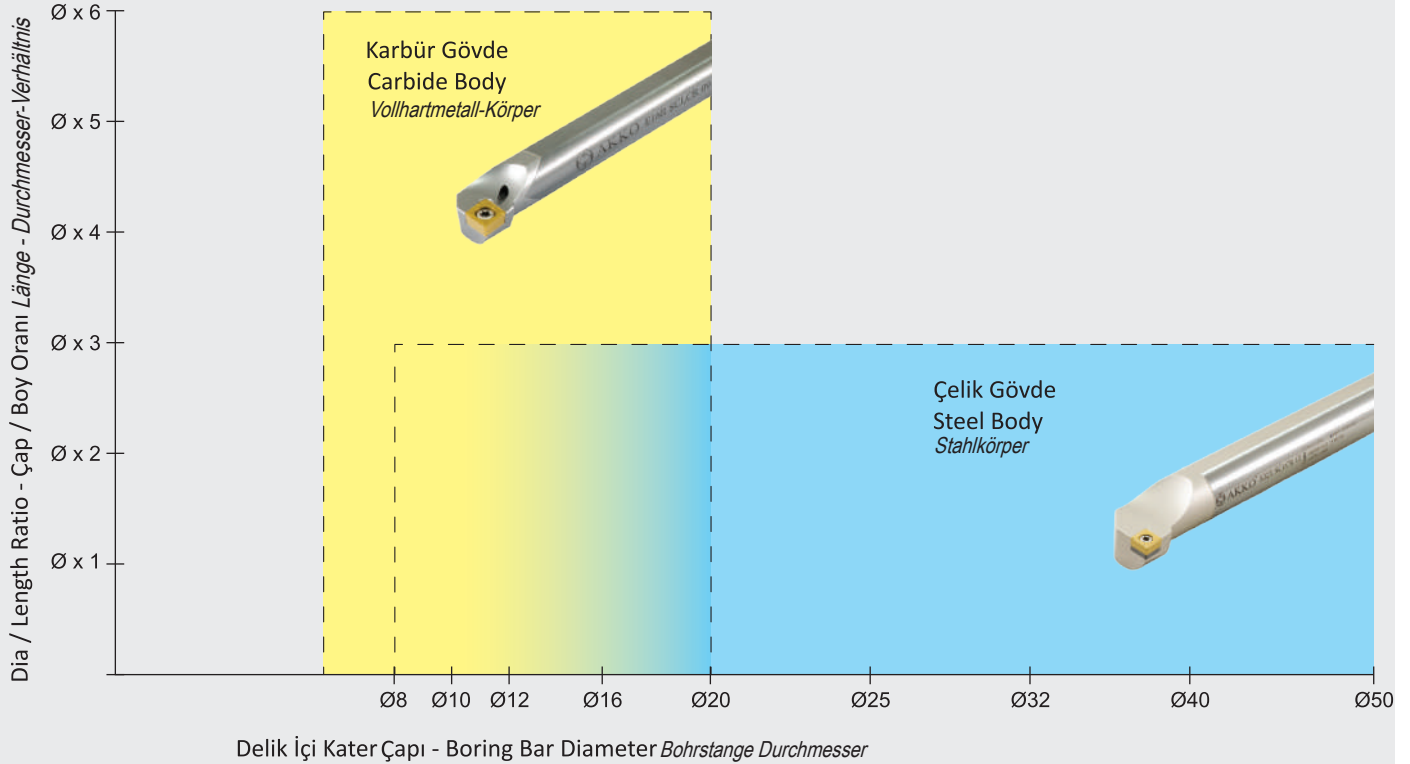

T Kanal Freze Kullanım ve Ön Hazırlama Kılavuzu

Application Guide For T-Slot Milling

Anwendungshinweise für T-Nutenfräser

T kanal frezelemede talaşın rahat boşaltılması için iş parçası resimde gösterildiği şekilde işlenmelidir.

Örnek: ATSM90-CC06- D32X10-W25- L100-Z04 kodlu T freze ile kanal açmadan önce, takımın boğazının çalışacağı kısmın parmak freze ile işlenmesi gerekir. Bu durumda kanalın tamamen işlenmesi çok yanlıştır. Tabanda ($0.8 \times b = 0.8 \times 10$) 8mm işlenmeden bırakılmalıdır. Bu bölgeyi T frezenin işlemesi, takımın daha sağlıklı çalışması açısından gereklidir.

İşlenen kanallarda yumuşak kesim için talaşlar uzaklaştırılmış olmalıdır.

When T slot machining steel, the workpiece must be machined as shown in the drawing to ensure smooth chip evacuation.

Example: Before slotting with the T - slot milling cutter - code ATSM90-CC06-D32X10-W25-L100-Z04,

The area of the neck of the tools to be worked and must be machined by End-Mill.

In this case, it is very wrong to machining the slot completely.

Bottom area ($0.8 \times b = 0.8 \times 10$) should be left 8 mm without machining.

This area's operation must be machined by the T- slot milling cutter which is also necessary for the healthier work of the tool holder. Slots to be machined must be free from chips for smooth machining.

Beim Einsatz von T-Nutenfräsern muss das Werkstück so bearbeitet werden wie es in der Zeichnung dargestellt ist, um einen problemlosen Spänentransport zu gewährleisten.

Bespiel: Einsatz des T-Nutenfräasers ATSM90-CC06-D32X10-W25-L100-Z04

Die Aussparung für den Halsbereich des T-Nutenfräasers muss mit einem Schaftfräser vorgearbeitet werden. Bitte beachten Sie dabei, dass die Aussparung nicht komplett bis auf den Grund gefräst wird, sondern eine Bodenstärke von $0,8 \times b$ (im Beispiel $0,8 \times 10 \text{ mm} = 8 \text{ mm}$) im Werkstück verbleibt.

Dieser Bereich soll mit dem T-Nutenfräser bearbeitet werden, da dies für die Stabilität und Standzeit des Werkzeugs besser ist. In der zu bearbeitenden Nut sollten keine Späne mehr vorhanden sei.

KULLANIM İÇİN UYARI

CAUTION FOR USE

Bitte beachten Sie!

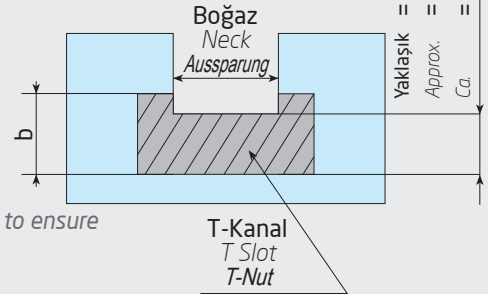

α = 5 Kat Dayanıklılık **α = 5 Times Long Life** **α = 5-Fache Standzeit**

Alfa Kaplamanın Avantajları

Alpha Coating
Advantages

Vorteile der
Alpha-Beschichtung

- **Yüksek aşınma direnci**
High resistance to abrasion
Hoher Verschleißschutz
- **Yüksek yüzey sertliği**
750-800 Vickers
High surface hardness
750-800 Vickers
Hohe Oberflächenhärte von
750-800 HV
- **Temperlemeye karşı yüksek direnç**
High resistance to tempering
Hoher Temperaturwiderstand
- **Yüksek yorulma mukavemeti**
High fatigue strength
Hohe Dauerfestigkeit
- **Yüksek çizik ve çentik direnci**
High scratch and impact resistance
Hoher Kratz- und Stoß-Widerstand
- **Paslanmaz olmayan çelikler için daha yüksek korozyon direnci**
Resistant to corrosion of
non-stainless steel
Korrosionsschutz

takımınız neden
daha uzun ömürlü
olmasın?...

longer tool life...

längere Werkzeug-Standzeit

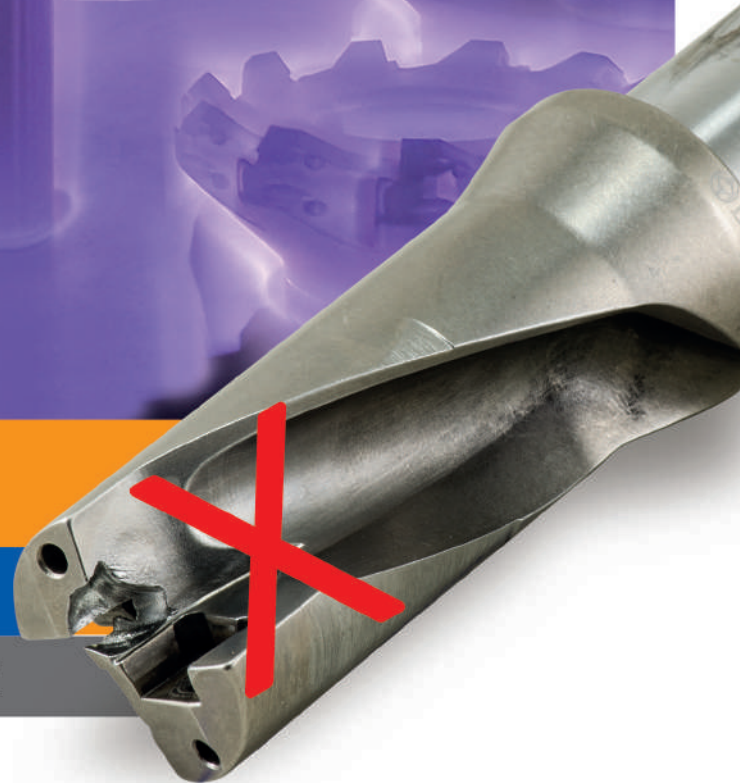

α Çevre Dostudur. α is friend of environment.
 α ist umweltfreundlich.

İnsan sağlığı açısından zararlı değildir. Is not harmful to human health.
Nicht gesundheitsschädlich.

Gaz ve diğer atıkları çevreyi kirlilemez. Gas and other wastes will not pollute the environment.
Umweltverträgliches Beschichtungsverfahren.

ALTLIKLAR / SHIMS / UNTERLAGE

ÜRÜN RESMİ/PICTURE BILD	ÜRÜN KODU/CODE BEZEICHNUNG	ÜRÜN DETAYI / PRODUCT DETAIL PRODUKTBESCHREIBUNG		
	AATN-2-0001	S-SİSTEM için / For S-SYSTEM / FÜR S-SYSTEM	TCMT 16 ALTLIK / SHIM / UNTERLAGE	
	AATN-2-0002	T-M SİSTEM için / For T-M SYSTEM / FÜR T-M-SYSTEM	TNMG 16 ALTLIK / SHIM / UNTERLAGE	
		C-SİSTEM için / For C-SYSTEM / FÜR C-SYSTEM	TNGN 16 ALTLIK / SHIM / UNTERLAGE	
	AATN-3-0025	P-SİSTEM için / For P-SYSTEM / FÜR P-SYSTEM	TNMG 16 ALTLIK / SHIM / UNTERLAGE	
	AATN-3-0015	T-M-P SİSTEM için / For T-M SYSTEM / FÜR T-M-P-SYSTEM	TNMG 22 ALTLIK / SHIM / UNTERLAGE	
	AATN-2-0020	DİŞ VİDA 16 ALTLIK / For THREADING 16 SHIM / 16 SHIM / GEWINDE 16 UNTERLAGE		
	AATN-2-0004	DİŞ VİDA 22 ALTLIK / For THREADING 22 SHIM / GEWINDE 22 UNTERLAGE		
	ATS-16E	DİŞ VİDA 16, DİŞ ÇAP SAĞ - DELİK İÇİ SOL ALTLIK / For THREADING SYSTEM 16 SHIM, EXTERNAL RIGHT-INTERNAL LEFT / FÜR 16 ER-GEWINDEPLATTE, EXTERN RECHTS- INTERN LINKS		
	ATS-16I	DİŞ VİDA 16, DİŞ ÇAP SOL - DELİK İÇİ SAĞ ALTLIK / For THREADING SYSTEM 16 SHIM, EXTERNAL LEFT-INTERNAL RIGHT / FÜR 16 ER-GEWINDEPLATTE, EXTERN LINKS - INTERN RECHTS		
	ATS-22E	DİŞ VİDA 22, DİŞ ÇAP SAĞ - DELİK İÇİ SOL ALTLIK / For THREADING SYSTEM 22 SHIM, EXTERNAL RIGHT-INTERNAL LEFT / FÜR 22 ER-GEWINDEPLATTE, EXTERN RECHTS- INTERN LINKS		
	ATS-22I	DİŞ VİDA 22, DİŞ ÇAP SOL - DELİK İÇİ SAĞ ALTLIK / For THREADING SYSTEM 22 SHIM, EXTERNAL LEFT-INTERNAL RIGHT / FÜR 22 ER-GEWINDEPLATTE, EXTERN LINKS - INTERN RECHTS		
	ATS-27E	DİŞ VİDA 27, DİŞ ÇAP SAĞ - DELİK İÇİ SOL ALTLIK / For THREADING SYSTEM 27 SHIM, EXTERNAL RIGHT-INTERNAL LEFT / FÜR 27 ER-GEWINDEPLATTE, EXTERN RECHTS- INTERN LINKS		
	ATS-27I	DİŞ VİDA 27, DİŞ ÇAP SOL - DELİK İÇİ SAĞ ALTLIK / For THREADING SYSTEM 27 SHIM, EXTERNAL LEFT-INTERNAL RIGHT / FÜR 27 ER-GEWINDEPLATTE, EXTERN LINKS - INTERN RECHTS		
	AACN-2-0001	S-SİSTEM için / For S-SYSTEM / FÜR S-SYSTEM	CCMT 09 ALTLIK / SHIM / UNTERLAGE	
		T-SİSTEM için / For T-SYSTEM / FÜR T-SYSTEM	CNMG 09 ALTLIK / SHIM / UNTERLAGE	
	AACN-2-0002	P-SİSTEM için / For P-SYSTEM / FÜR P-SYSTEM	CNMG 09 ALTLIK / SHIM / UNTERLAGE	
	AACN-2-0003	S-SİSTEM için / For S-SYSTEM / FÜR S-SYSTEM	CCMT 12 ALTLIK / SHIM / UNTERLAGE	
		T-M-P SİSTEM için / For T-M-P SYSTEM / FÜR T-M-P-SYSTEM	CNMG 12 ALTLIK / SHIM / UNTERLAGE	
	AACN-3-0001	C-SİSTEM için / For C-SYSTEM / FÜR C-SYSTEM	CNGN 12 ALTLIK / SHIM / UNTERLAGE	
	AACN-3-0002	T-P SİSTEM için / For T-P SYSTEM / FÜR T-P-SYSTEM	CNMG 16 ALTLIK / SHIM / UNTERLAGE	
	AACN-3-0003	T-P SİSTEM için / For T-P SYSTEM / FÜR T-P-SYSTEM	CNMG 19 ALTLIK / SHIM / UNTERLAGE	
	AACN-3-0008	T-P SİSTEM için / For T-P SYSTEM / FÜR T-P-SYSTEM	CNMG 25 ALTLIK / SHIM / UNTERLAGE	
	AAWN-2-0003	T-M-P SİSTEM için / For T-M-P SYSTEM / FÜR T-M-P-SYSTEM	WNMG 08 KALIN ALTLIK / THICK SHIM / DICKE UNTERLAGE	
	AAWN-3-0001	T-M-P SİSTEM için / For T-M-P SYSTEM / FÜR T-M-P-SYSTEM	WNMG 08 ALTLIK / SHIM / UNTERLAGE	
	AAWN-SW317	T-M-P SİSTEM için / For T-M-P SYSTEM / FÜR T-M-P-SYSTEM	WNMG 06 ALTLIK / SHIM / UNTERLAGE	
	AKS-16L	C-SİSTEM için / For C-SYSTEM / FÜR C-SYSTEM	KNUX-L 16 ALTLIK / SHIM / UNTERLAGE	
	AKS-16R	C-SİSTEM için / For C-SYSTEM / FÜR C-SYSTEM	KNUX-R 16 ALTLIK / SHIM / UNTERLAGE	
	AASD-3-0001	S-SİSTEM FREZELEME için / For S-SYSTEM MILLING / S-SYSTEM FÜR FRÄSER	SDMT 12 ALTLIK / SHIM / UNTERLAGE	
	AASE-3-0001	S-SİSTEM FREZELEME için / For S-SYSTEM MILLING / S-SYSTEM FÜR FRÄSER	SEMT 13 ALTLIK / SHIM / UNTERLAGE	
	AASN-2-0001	S-SİSTEM için / For S-SYSTEM / FÜR S-SYSTEM	SCMT 09 ALTLIK / SHIM / UNTERLAGE	
	AASN-2-0002	P-SİSTEM için / For P-SYSTEM / FÜR P-SYSTEM	SNMG 09 ALTLIK / SHIM / UNTERLAGE	
	AASN-2-0004	S-SİSTEM için / For S-SYSTEM / FÜR S-SYSTEM	SCMT 12 ALTLIK / SHIM / UNTERLAGE	
		T-P SİSTEM için / For T-P SYSTEM / FÜR T-P-SYSTEM	SNMG 12 ALTLIK / SHIM / UNTERLAGE	
	AASN-3-0004	C-SİSTEM için / For C-SYSTEM / FÜR C-SYSTEM	SNGN 12 ALTLIK / SHIM / UNTERLAGE	
	AASN-3-0023	T-P SİSTEM için / For T-P SYSTEM / T-P TMI7	SNMG 15 ALTLIK / SHIM / UNTERLAGE	
	AASN-3-0005	T-P SİSTEM için / For T-P SYSTEM / FÜR T-P-SYSTEM	SNMG 19 ALTLIK / SHIM / UNTERLAGE	
	AASN-3-0020	T-P SİSTEM için / For T-P SYSTEM / FÜR T-P-SYSTEM	SNMG 25 ALTLIK / SHIM / UNTERLAGE	
	AASN-20020	PSDNN KARTUŞ için / For PSDNN CARTRIDGE / FÜR PSDNN-KURZDREHHALTER	SNMG 12 ALTLIK / SHIM / UNTERLAGE	
		AADN-2-0001	S-SİSTEM için / For S-SYSTEM / FÜR S-SYSTEM	DCMT 11 ALTLIK / SHIM / UNTERLAGE
			T-SİSTEM için / For T-SYSTEM / FÜR T-SYSTEM	DNMG 11 ALTLIK / SHIM / UNTERLAGE
		AADN-SD317	P-SİSTEM için / For P-SYSTEM / FÜR P-SYSTEM	DNMG 11 ALTLIK / SHIM / UNTERLAGE
		AADN-3-0001	T-M-P SİSTEM için / For T-M-P SYSTEM / FÜR T-M-P-SYSTEM	DNMG 15 ALTLIK / SHIM / UNTERLAGE
			C-SİSTEM için / For C-SYSTEM / FÜR C-SYSTEM	DNGN 15 ALTLIK / SHIM / UNTERLAGE
	AADN-2-0003	T-SİSTEM için / For T-SYSTEM / FÜR T-SYSTEM	DNMG 15 KALIN ALTLIK / THICK SHIM / DICKE UNTERLAGE	
		AAVN-2-0002	S-SİSTEM için / For S-SYSTEM / FÜR S-SYSTEM	VBMT 16, VCMT 16 ALTLIK / SHIM / UNTERLAGE
		T-SİSTEM için / For T-SYSTEM / FÜR T-SYSTEM	VNMG 16 ALTLIK / SHIM / UNTERLAGE	
AAVN-2-0003		S-SİSTEM için / For S-SYSTEM / FÜR S-SYSTEM	VCMT 22 ALTLIK / SHIM / UNTERLAGE	
	AARC-3-0001	C-SİSTEM için / For C-SYSTEM / FÜR C-SYSTEM	RCGX 06 ALTLIK / SHIM / UNTERLAGE	
	AARC-3-0002	C-SİSTEM için / For C-SYSTEM / FÜR C-SYSTEM	RCGX 09 ALTLIK / SHIM / UNTERLAGE	
	AARC-3-0003	C-SİSTEM için / For C-SYSTEM / FÜR C-SYSTEM	RCGX 12 ALTLIK / SHIM / UNTERLAGE	
	AARC-3-0005	C-SİSTEM için / For C-SYSTEM / FÜR C-SYSTEM	RCGX 06 ALTLIK / SHIM / UNTERLAGE	
	AARC-3-0006	C-SİSTEM için / For C-SYSTEM / FÜR C-SYSTEM	RCGX 09 ALTLIK / SHIM / UNTERLAGE	
	AARC-3-0007	C-SİSTEM için / For C-SYSTEM / FÜR C-SYSTEM	RCGX 12 ALTLIK / SHIM / UNTERLAGE	

BASKI PABUÇLARI / CLAMPS / SPANNSPRATZE

ÜRÜN RESMİ/PICTURE BILD	ÜRÜN KODU/CODE BEZEICHNUNG	ÜRÜN DETAYI / PRODUCT DETAIL PRODUKTBESCHREIBUNG
	ATK-01	T-SİSTEM için / For T-SYSTEM / FÜR T-SYSTEM DNMG 11, WNMG 06, TNMG 16, CNMG 09 BASKI PABUCU / CLAMP / PRATZE
	ATK-02	T-SİSTEM için / For T-SYSTEM / FÜR T-SYSTEM CNMG 12, WNMG 08, TNMG 22, DNMG 15, SNMG 12 BASKI PABUCU / CLAMP / PRATZE
	ATK-03	T-SİSTEM için / For T-SYSTEM / FÜR T-SYSTEM VNMG 16 BASKI PABUCU / CLAMP / PRATZE
	ATK-04	T-SİSTEM için / For T-SYSTEM / FÜR T-SYSTEM CNMG 16, SNMG 15 BASKI PABUCU / CLAMP / PRATZE
	ATKH-01-R	T-SİSTEM için / For T-SYSTEM / FÜR T-SYSTEM CNMG 12 İÇTEN SOĞUTMA KANALLI BASKI PABUCU / WITH COOLANT TOOLS / INNENKÜHLUNG
	ATKH-02-L	T-SİSTEM için / For T-SYSTEM / FÜR T-SYSTEM CNMG 12 İÇTEN SOĞUTMA KANALLI BASKI PABUCU / WITH COOLANT TOOLS / INNENKÜHLUNG
	ATKH-03-R	T-SİSTEM için / For T-SYSTEM / FÜR T-SYSTEM TNMG 16 İÇTEN SOĞUTMA KANALLI BASKI PABUCU / WITH COOLANT TOOLS / INNENKÜHLUNG
	ATKH-04-L	T-SİSTEM için / For T-SYSTEM / FÜR T-SYSTEM TNMG 16 İÇTEN SOĞUTMA KANALLI BASKI PABUCU / WITH COOLANT TOOLS / INNENKÜHLUNG
	ATKH-05-R	T-SİSTEM için / For T-SYSTEM / FÜR T-SYSTEM VNMG 16 İÇTEN SOĞUTMA KANALLI BASKI PABUCU / WITH COOLANT TOOLS / INNENKÜHLUNG
	ATKH-06-L	T-SİSTEM için / For T-SYSTEM / FÜR T-SYSTEM VNMG 16 İÇTEN SOĞUTMA KANALLI BASKI PABUCU / WITH COOLANT TOOLS / INNENKÜHLUNG
	ATKH-07-R	T-SİSTEM için / For T-SYSTEM / FÜR T-SYSTEM SNMG 15 İÇTEN SOĞUTMA KANALLI BASKI PABUCU / WITH COOLANT TOOLS / INNENKÜHLUNG
	ATKH-08-L	T-SİSTEM için / For T-SYSTEM / FÜR T-SYSTEM SNMG 15 İÇTEN SOĞUTMA KANALLI BASKI PABUCU / WITH COOLANT TOOLS / INNENKÜHLUNG
	ATKH-09-R	T-SİSTEM için / For T-SYSTEM / FÜR T-SYSTEM CNMG 12 İÇTEN SOĞUTMA KANALLI BASKI PABUCU / WITH COOLANT TOOLS / INNENKÜHLUNG
	ATKH-10-L	T-SİSTEM için / For T-SYSTEM / FÜR T-SYSTEM CNMG 12 İÇTEN SOĞUTMA KANALLI BASKI PABUCU / WITH COOLANT TOOLS / INNENKÜHLUNG
	AMK-01	M-SİSTEM için / For M-SYSTEM / FÜR M-SYSTEM WNMG 06 BASKI PABUCU / CLAMP / PRATZE
	AMK-02	M-SİSTEM için / For M-SYSTEM / FÜR M-SYSTEM DELİK İÇİ / INTERNAL Ø20 TNMG 16, Ø25 MT-NRL 16 BASKI PABUCU / CLAMP / PRATZE
	AMK-03	M-SİSTEM için / For M-SYSTEM / FÜR M-SYSTEM DNMG 11, CNMG 12 BASKI PABUCU / CLAMP / PRATZE
	AMK-04	M-SİSTEM için / For M-SYSTEM / FÜR M-SYSTEM DNMG 15, TNMG 16-22 BASKI PABUCU / CLAMP / PRATZE
	AMK-05	M-SİSTEM için / For M-SYSTEM / FÜR M-SYSTEM WNMG 08 BASKI PABUCU / CLAMP / PRATZE
	AMK-07	M-SİSTEM için / For M-SYSTEM / FÜR M-SYSTEM S20R MCLN/RL BASKI PABUCU / CLAMP / PRATZE
	AMK-08	M-SİSTEM için / For M-SYSTEM / FÜR M-SYSTEM TNMG 22 BASKI PABUCU / CLAMP / PRATZE
	ACK-01-R	C-SİSTEM için / For C-SYSTEM / FÜR C-SYSTEM KNUX-R BASKI PABUCU / CLAMP / PRATZE
	ACK-02-L	C-SİSTEM için / For C-SYSTEM / FÜR C-SYSTEM KNUX-L BASKI PABUCU / CLAMP / PRATZE
	ACK-03	C-SİSTEM için / For C-SYSTEM / FÜR C-SYSTEM 154.91 DIŞ ÇAP ve DELİK İÇİ/EXTERNAL and INTERNAL/ AUBEN-DREHHALTER Ø25-Ø32 / PABUCU / CLAMP / PRATZE
	ACK-04	P-C-SİSTEM için / For P-C-SYSTEM / FÜR P-C-SYSTEM CTFPR KARTUŞ BASKI PABUCU / CARTRIDGE CLAMP / PRATZE FÜR CASSETTE
	ACK-05	P-C-SİSTEM için / For P-C-SYSTEM / FÜR P-C-SYSTEM FREZELEME ve DIŞ VIDAÇAMA TAKIMLARINA GÖRE İLAVE BASKI PABUCU ADDITIONAL LITTLE CLAMP for MILLING and THREADING CLAMP KLEINE ZUSATZKLEMME FÜR FRÄSER UND GEWINDEWERKZEUGE
	ACK-06	C-SİSTEM için / For C-SYSTEM / FÜR C-SYSTEM 154.91 DELİK İÇİ / INTERNAL / INNEN Ø16-Ø20 BASKI PABUCU / CLAMP / PRATZE
	ACK-07	C-SİSTEM için / For C-SYSTEM / FÜR C-SYSTEM SERAMİK CNGN, SNGN, DNGN YEDEK TAKIMI SPARE PART SET of CERAMIC CNGN, SNGN, DNGN ERSATZTEILSATZ FÜR KERAMIK CNGN, SNGN, DNGN SERAMİK TNGN, YEDEK TAKIMI SPARE PART SET of CERAMIC TNGN ERSATZTEILSATZ FÜR KERAMİK TNGN
	ACK-08	C-SİSTEM için / For C-SYSTEM / FÜR C-SYSTEM
	ACK-09	P-SİSTEM için / For P-SYSTEM / FÜR P-SYSTEM CNMG 16-19, SNMG 15-19 İLAVE BÜYÜK BASKI PABUCU ADDITIONAL BIG CLAMP / ZUSÄTZLICHE GROSSE KLEMME
	ACK-10	C-SİSTEM FREZELEME için / For C-SYSTEM MILLING C-SİSTEM FÜR FRÄSER SPKN 12, Ø50-Ø63 TPKN 16 BASKI PABUCU / CLAMP / PRATZE (M8x8)
	ACK-11	C-SİSTEM FREZELEME için / For C-SYSTEM MILLING C-SİSTEM FÜR FRÄSER Ø80-Ø100 TPKN 16-TPKN 22, OFKR 07, HNMX 09 BASKI PABUCU / CLAMP / PRATZE (M8x10)
	ACK-12	C-SİSTEM için / For C-SYSTEM / FÜR C-SYSTEM CTSPR KARTUŞ BASKI PABUCU / CARTRIDGE CLAMP
	ACK-15	S-SİSTEM FREZELEME için / For S-SYSTEM MILLING S-SİSTEM FÜR FRÄSER RD.. 10-12 BASKI PABUCU / CLAMP / PRATZE
	ACK-19	S-SİSTEM FREZELEME için / For S-SYSTEM MILLING S-SİSTEM FÜR FRÄSER WD0805D BASKI PABUCU / CLAMP / PRATZE
	ACK-21	C-SİSTEM için / For C-SYSTEM / FÜR C-SYSTEM SN.. 1204.. BASKI PABUCU / CLAMP / PRATZE
	ACK-23	C-SİSTEM için / For C-SYSTEM / FÜR C-SYSTEM SERAMİK DNGN 11, YEDEK TAKIMI SPARE PART SET of CERAMIC DNGN 11 ERSATZTEILSATZ FÜR KERAMİK DNGN 11
	ACK-24	S-SİSTEM FREZELEME için / For S-SYSTEM MILLING S-SİSTEM FÜR FRÄSER XD0806D BASKI PABUCU / CLAMP / PRATZE
	ACK-26	C-SİSTEM için / For C-SYSTEM / FÜR C-SYSTEM XNMU 0806.. BASKI PABUCU / CLAMP / PRATZE
	ACK-27	C-SİSTEM için / For C-SYSTEM / FÜR C-SYSTEM RCGX 06 BASKI PABUCU / CLAMP / PRATZE
	ACK-28	C-SİSTEM için / For C-SYSTEM / FÜR C-SYSTEM RCGX 09 BASKI PABUCU / CLAMP / PRATZE
	ACK-29	C-SİSTEM için / For C-SYSTEM / FÜR C-SYSTEM RCGX 12 BASKI PABUCU / CLAMP / PRATZE
	ACK-42	C-SİSTEM için / For C-SYSTEM / FÜR C-SYSTEM RCGX 06 BASKI PABUCU / CLAMP / PRATZE
	ACK-43	C-SİSTEM için / For C-SYSTEM / FÜR C-SYSTEM RCGX 09 BASKI PABUCU / CLAMP / PRATZE
	ACK-44	C-SİSTEM için / For C-SYSTEM / FÜR C-SYSTEM RCGX 12 BASKI PABUCU / CLAMP / PRATZE

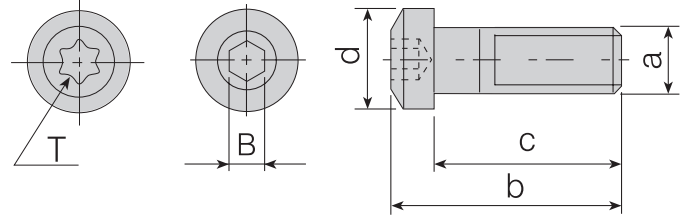
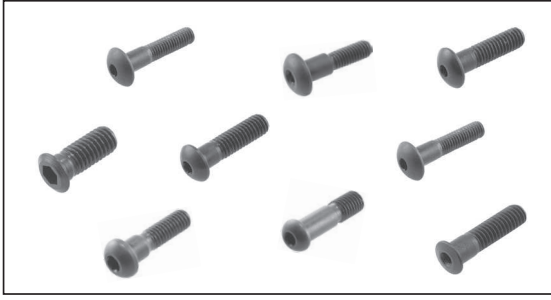

BASKI PABUÇ VİDALARI / CLAMP SCREWS / SCHRAUBEN FÜR PRATZEN

Takım Kodu Ordering Code Bestell-Bezeichnung	a (M)	b	c	d	B(T)	Ürün Detayı / Product Detail / Produkt-Details
AKV-01-M5x22	M5x0.8	25	22	11	3	T-SİSTEM için / For T-SYSTEM / FÜR T-SYSTEM DNMG 11, WNMG 06, TNMG 16
AKV-02-M6x22	M6x1.0	25	22	11	3	T-SİSTEM için / For T-SYSTEM / FÜR T-SYSTEM CNMG 12, WNMG 08, TNMG 22, DNMG 15, SNMG 12, VNMG 16 M-SİSTEM için / For M-SYSTEM / FÜR M-SYSTEM TNMG 16, TNMG 22 KANAL KATERİ için / For EXTERNAL GROOVING 2mm Dış Çap Kanal Kater Vidası / External Grooving Tools Screw FÜR STECHWERKZEUGE 2 mm Schraube für Außen-Steckwerkzeuge
AKV-03-M6x22	M6x1.0	24.5	22	10	3	M-SİSTEM için / For M-SYSTEM / FÜR M-SYSTEM WNMG 08
AKV-04-M5x17	M6x1.0	20	17	8.35	3	M-SİSTEM için / For M-SYSTEM / FÜR M-SYSTEM S20R MT-NR/L 16, S20R-S25S MWLNRL 06, S25S MDUNR/L 11-Dış Çap / External / AÜßEN MWLNRL 06
AKV-05-M6x10	T-SİSTEM için / For T-SYSTEM / FÜR T-SYSTEM Eski Ürün Vidası / Old Products Screws / Schraube für altes Produkt CNMG 16, SNMG 15
AKV-06-M6x20	M6x1.0	26.5	20	10.6	4	C-SİSTEM için / For C-SYSTEM / FÜR C-SYSTEM KNUX 16
AKV-07-M6x22	M6x1.0	24	22	8.5	3	C-SİSTEM için / For C-SYSTEM / FÜR C-SYSTEM ADKT-154.91, AIKT-154.91-R/L-32
AKV-10-M6x14	M6x1.0	18	17	8.5	4	C-SİSTEM için / For C-SYSTEM / FÜR C-SYSTEM AIKT-154.91-R/L-16, AIKT-154.91-R/L-20, AIKT-154.91-R/L-25
AKV-11-M8x29	M8x1.25	34	29	11	4	C-SİSTEM için / For C-SYSTEM / FÜR C-SYSTEM TNGN 16, CNGN 12, DNGN 15, SNGN 12
AKV-17-M5x15	M5x0.8	18	15	8.5	3	M-SİSTEM için / For M-SYSTEM / FÜR M-SYSTEM S16P MWLNRL 06
AKV-19-M7x25	M7x1.0	29	25	13	4	T-SİSTEM için / For T-SYSTEM / FÜR T-SYSTEM Yeni / New / Neu CNMG 16, SNMG 15
AKV-20-M6x19	M6x1.0	21.5	19	10	3	M-SİSTEM için / For M-SYSTEM / FÜR M-SYSTEM S25S MDUNR/L 15
AKV-21-M6x18	M6x1.0	18	16	8.5	3	C-SİSTEM için / For C-SYSTEM / FÜR C-SYSTEM AIKT-154.91-R/L-25
AKV-23-M4x10	M4x0.7	12	10	7.4	15	KARTUŞ için / For CARTRIDGE / ДЛЯ КАРТРИДЖЕЙ Montaj Vidası / Mounting Screw / Befestigungsschraube
AKV-27-M6x20	M6x1.0	21.5	19	10	3	M-SİSTEM için / For M-SYSTEM / FÜR M-SYSTEM S25S MWLNRL 08
AKV-30-M6x22	M6x1.0	25	22	11	3	T-SİSTEM için / For T-SYSTEM / FÜR T-SYSTEM Baskı Pabucu / Wedge Clamp / Spannpratze
AKV-33-M6x22	M6x1.0	25	22.5	9.5	3	T-SİSTEM için / For T-SYSTEM / FÜR T-SYSTEM T-SİSTEM için / For T-SYSTEM / FÜR T-SYSTEM
AKV-39-M7x21	M7x1.0	25.5	21	11.5	4	T-SİSTEM için / For T-SYSTEM / FÜR T-SYSTEM T-SİSTEM için / For T-SYSTEM / FÜR T-SYSTEM

SOĞUTMA NOZULU / COOLANT NOZZLE / KÜHLMITTELDÜSE

Ürün Resmi Product Picture Produkt-Bild	Ürün Kodu Product Code / Code	Ürün Detayı / Product Detail / Produkt-Details
	AN-01	SOĞUTMA NOZULU / Coolant Nozzle / KÜHLMITTELDÜSE

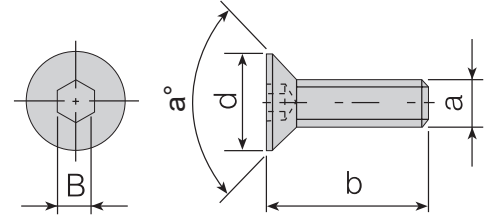

ALTLIK VIDALARI / SHIM SCREWS / SCHRAUBE FÜR UNTERLAGE

Takım Kodu Ordering Code Bestell-Bezeichnung	a (M)	b	d	B	a°	Ürün Detayı / Product Detail / Produkt-Details
AAV-01-M3x10	M3x0.5	10	5.9	2	90°	T-SİSTEM için / For T-SYSTEM / FÜR T-SYSTEM WNMG 06, KNUX 16
AAV-02-M5x12	M5x0.8	12	7	3	56°	T-SİSTEM için / For T-SYSTEM / FÜR T-SYSTEM CNMG 12, WNMG 08, TNMG 22, DNMG 15, SNMG 12
AAV-05-M6x15	M6x1.0	15	9	4	60°	T-SİSTEM için / For T-SYSTEM / FÜR T-SYSTEM CNMG 16, SNMG 15
AKV-12-M5x12	M5x0.8	12	7.8	3	90°	C-SİSTEM için / For C-SYSTEM / FÜR C-SYSTEM CTSPR Baskı Pabuç Vidası / Clamp Screw / Зажимной винт
AKV-16-M6x16	M6x1.0	16	10	4	76°	C-SİSTEM için / For C-SYSTEM / FÜR C-SYSTEM CTFPR 13CS 16 Baskı Pabuç Vidası / Clamp Screw / Зажимной винт
AAV-13-M5x8	M5x0.8	8	7	3	56°	T-SİSTEM için / For T-SYSTEM / FÜR T-SYSTEM S25S TSKNR/L 12, S25S TCLNR/L 12, S25S TWLNR/L 08, S25S TDUNR/L 15
AAV-14-M5x14	M5x0.8	14	8.8	3	45°	ADCR için / For ADCR / FÜR ADCR ADCR Montaj Vidası / Mounting Screw / ADCR BEFESTIGUNGSSCHRAUBE

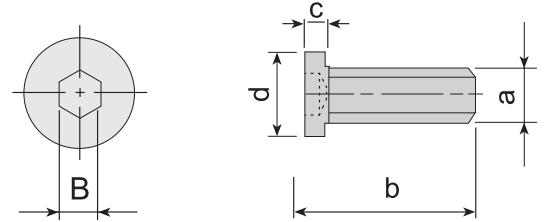

ALTLIK VIDALARI / SHIM SCREWS / SCHRAUBE FÜR UNTERLAGE

Takım Kodu Ordering Code Bestell-Bezeichnung	a (M)	b	c	d	B	Ürün Detayı / Product Detail / Produkt-Details
AAV-03-M5x12	M5x0.8	12	1.4	6	3	T-SİSTEM için / For T-SYSTEM / FÜR T-SYSTEM TNMG 16 C-SİSTEM için / For C-SYSTEM / FÜR C-SYSTEM TNGN 16
AAV-04-M5x12	M5x0.8	12	1.2	6.5	3	T-SİSTEM için / For T-SYSTEM / FÜR T-SYSTEM VNMG 16, DNMG 11, CNMG 09
AAV-09-M5x9	M5x0.8	9	1.4	6	3	T-SİSTEM için / For T-SYSTEM / FÜR T-SYSTEM S25S TCLNR/L 09, S25S TDUNR/L 11, S25S TDQNR/L 11

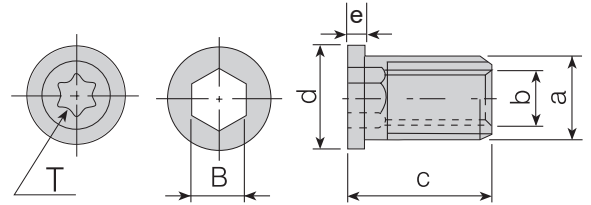
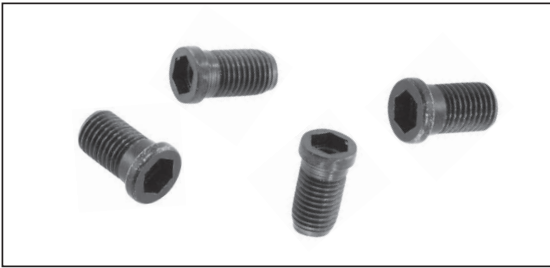

BUKSE VIDALAR / BUKSE SCREWS / SCHRAUBE FÜR UNTERLAGE

Takım Kodu Ordering Code Bestell-Bezeichnung	a (M)	b	c	d	B(T)	e	Ürün Detayı / Product Detail / Produkt-Details
AAV-06-M3.5x11	M3.5x0.5	M3.5x0.6	11.3	6	3.5	1.2	S-SİSTEM için / For S-SYSTEM / FÜR S-SYSTEM CCMT 09, DCMT 11, VBMT 16, VCMT 16, TCMT 16, SCMT 09, 16 ER/L, 16 IR/L
AAV-07-M4.5x13	M4.5x0.75	M4.5x0.75	13	7.5	4.5	1.6	S-SİSTEM için / For S-SYSTEM / FÜR S-SYSTEM CCMT 12, SCMT 12, 22 ER/L, 22 IR/L
AAV-08-M3.5x8	M3.5x0.5	M3.5x0.6	8	6	20	1.2	S-SİSTEM için / For S-SYSTEM / FÜR S-SYSTEM Ø25 DCMT 11, Ø25-Ø32 CCMT 09, Ø25 TCMT 16, S25S-S32T SVJBR/L 16,
AAV-10-M4.5x8	M4.5x0.75	M4.5x0.75	8	7.5	4.5	1.05	S-SİSTEM için / For S-SYSTEM / FÜR S-SYSTEM Ø25-Ø32 CCMT 12, Ø25-Ø32 SCMT 12, SSDCN 1616 H12, SSSCR/L 1616 H12, SIR/L S25R 22
AAV-16-M3.5x8	M3.5x0.5	M3.5x0.6	8	6	20	1.1	S-SİSTEM için / For S-SYSTEM / FÜR S-SYSTEM SEMT 13

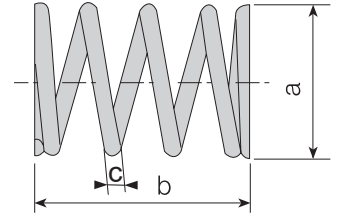
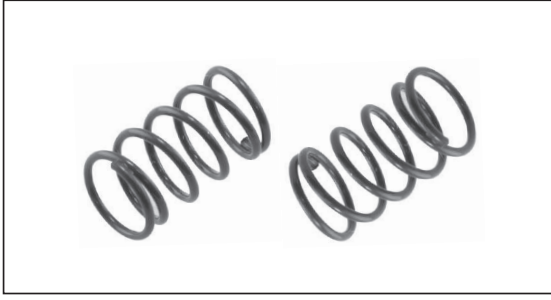

BASKI YAYI / CLAMP SPRING / FEDER FÜR KLEMME

Takım Kodu Ordering Code Bestell-Bezeichnung	a	b	c	Ürün Detayı / Product Detail / Produkt-Details
AKY-01	7.7	11.2	0.9	T-SİSTEM için / For T-SYSTEM / FÜR T-SYSTEM / CNMG 12, WNMG 08, TNMG 22, DNMG 15, SNMG 12, VNMG 16
AKY-02	8.5	13.5	0.7	C-SİSTEM için / For C-SYSTEM / FÜR C-SYSTEM / KNUX 16

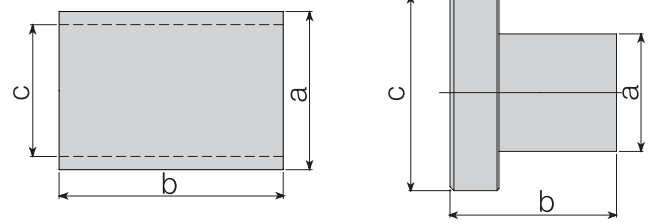
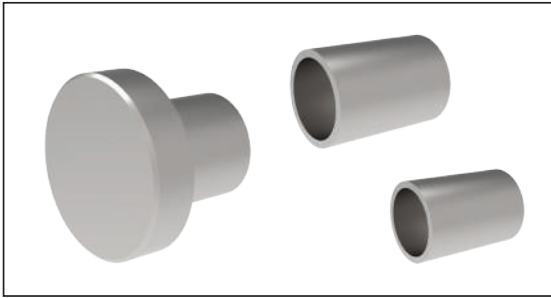

BAĞLANTI PARÇASI / CONNECTION PART / VERBINDUNGSTÜCK

Takım Kodu Ordering Code Bestell-Bezeichnung	a	b	c	Ürün Detayı / Product Detail / Produkt-Details
ACP-01	6	8.5	10	TIRLAMAZ TAKIM KARTUŞLARI İÇİN / FOR ANTI VIBRATION TOOLS CARTRIDGES / KARTUSCHE FÜR SCHWINGUNGSHEMMENDE BOHRSTANGEN
ACP-02	6	8.5	5	TIRLAMAZ TAKIM KARTUŞLARI İÇİN / FOR ANTI VIBRATION TOOLS CARTRIDGES / KARTUSCHE FÜR SCHWINGUNGSHEMMENDE BOHRSTANGEN
ACP-03	4	5	3	TIRLAMAZ TAKIM KARTUŞLARI İÇİN / FOR ANTI VIBRATION TOOLS CARTRIDGES / KARTUSCHE FÜR SCHWINGUNGSHEMMENDE BOHRSTANGEN

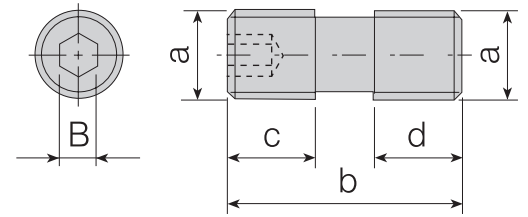

BASKI PABUÇ VIDALARI / CLAMP SCREWS / SCHRAUBEN FÜR PRATZEN

Takım Kodu Ordering Code Bestell-Bezeichnung	a (M)	b	c	d	B	Ürün Detayı / Product Detail / Produkt-Details
AKV-13-M8x1x16	M8x1.0	16	6.8	6.8	4	C-SİSTEM FREZELEME için / MILLING For C- SYSTEM / FÜR C-SYSTEM / SPKN 12, Ø63 TPKN 16
AKV-14-M8x1x18	M8x1.0	18	8	8	4	C-SİSTEM FREZELEME için / MILLING For C- SYSTEM / FÜR C-SYSTEM / Ø80-Ø100 TPKN 16, Ø63-Ø315 TPKN 22
AKV-15-M8x1x20	M8x1.0	20	8.5	8.5	4	C-SİSTEM FREZELEME için / MILLING For C- SYSTEM / FÜR C-SYSTEM / OFKR 07, HNMX 09
AKV-18-M5x14	M5x0.8	15	5	6.8	2.5	C-SİSTEM FREZELEME için / MILLING For C- SYSTEM / FÜR C-SYSTEM / SN19
AKV-22-M8x1x14	M8x1.0	14	6.8	4.8	4	C-SİSTEM FREZELEME için / MILLING For C- SYSTEM / FÜR C-SYSTEM / Ø50 TPKN 16
AKV-24-M6x1x18	M6x1.0	18	7.5	7.5	3	C-SİSTEM FREZELEME için / MILLING For C- SYSTEM / FÜR C-SYSTEM / SN.. 1204
AKV-26-M6x0.75x20	M6x0.75	20	8.5	8.5	3	C-SİSTEM FREZELEME için / MILLING For C- SYSTEM / FÜR C-SYSTEM / AFM45C-XN0806
AKV-28-M10x1.5x43	M10x1.5	43	18	18	5	WNMU 0907.. Ø50 MONTAJ VIDASI / MOUNTING SCREW / BEFESTIGUNGSSCHRAUBE / WNMU 0907.. Ø50

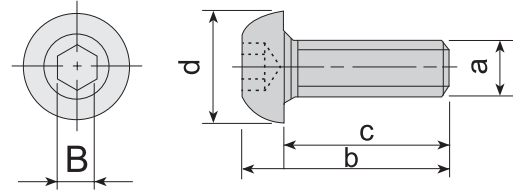

Takım Kodu Ordering Code Bestell-Bezeichnung	KANAL KATER ve MANTAR VİDALAR / GROOVING TOOL and CLAMP SCREWS / KLEMMSCHRAUBEN					Ürün Detayı / Product Detail / Produkt-Details
	a (M)	b	c	d	B	
1904-M8x1x20	M8x1.0	25.9	20	11.3	4	S-SİSTEM için / For S-SYSTEM / FÜR S-SYSTEM RCMT 32 Sıkma Vidası / Clamp Screw / Klemmschraube
2004-M8x1x20	M8x1.0	25.9	20	11.4	4	KANAL KATER için / For EXTERNAL GROOVING / FÜR TMG-16, TMG-22 BOHRSTANGE Kanal Kater Vidası / External Grooving Tools Screw / SCHRAUBEN FÜR STECHHALTER
2004-M8x20	M8x1.25	30	25	25	4	KANAL KATER için / For EXTERNAL GROOVING / FÜR TMG-16, TMG-22 BOHRSTANGE Eski Kanal Kater Vidası / Old External Grooving Tools Screw Alte / Schraube für Stechhalter
AKV-08-M6x12	M6x1.0	17	12	14.3	4	C-SİSTEM FREZELEME için / MILLING For C-SYSTEM / C-SYSTEM FÜR FRÄSER Baskı ve Sıkma Vidası, Mantar Vida / Clamp Screw / Klemmschraube
AKV-09-M8x18	M8x1.0	24	18	17.2	5	C-SİSTEM FREZELEME için / MILLING For C-SYSTEM / C-SYSTEM FÜR FRÄSER Baskı ve Sıkma Vidası, Mantar Vida / Clamp Screw / Klemmschraube

Ürün Resmi Product Picture Produkt-Bild	LEVYELER / LEVERS / KNIEHEBEL		
	Ürün Kodu Product Code / Code	Ürün Detayı / Product Detail / Produkt-Details	
	APL-01	P-SİSTEM için / For P-SYSTEM / FÜR P-SYSTEM	CNMG 09, DNMG 11, SNMG 09, TNMG 16, WNMG 06 LEVYESİ / LEVER / KNIEHEBE
	APL-02	P-SİSTEM için / For P-SYSTEM / FÜR P-SYSTEM	CNMG 12, SNMG 12, TNMG 22, WNMG 08 LEVYESİ / LEVER / KNIEHEBE
	APL-03	P-SİSTEM için / For P-SYSTEM / FÜR P-SYSTEM	DNMG 15 LEVYESİ / LEVER / KNIEHEBE
	APL-04	P-SİSTEM için / For P-SYSTEM / FÜR P-SYSTEM	CNMG 16, SNMG 15 LEVYESİ / LEVER / KNIEHEBEL
	APL-05	P-SİSTEM için / For P-SYSTEM / FÜR P-SYSTEM	CNMG 19, SNMG 19 LEVYESİ / LEVER / KNIEHEBEL
	APL-06	P-SİSTEM için / For P-SYSTEM / FÜR P-SYSTEM	CNMG 25, SNMG 25 LEVYESİ / LEVER / KNIEHEBEL
	APL-07	P-SİSTEM için / For P-SYSTEM / FÜR P-SYSTEM	S16P PCLNR/L 09 LEVYESİ / LEVER / KNIEHEBEL
	APL-08	P-SİSTEM için / For P-SYSTEM / FÜR P-SYSTEM	S16P PTUNR/L 16 LEVYESİ / LEVER / KNIEHEBEL
	APL-11	P-SİSTEM için / For P-SYSTEM / FÜR P-SYSTEM	TNMG 11 LEVYESİ / LEVER / KNIEHEBEL

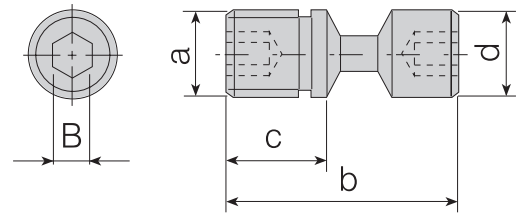
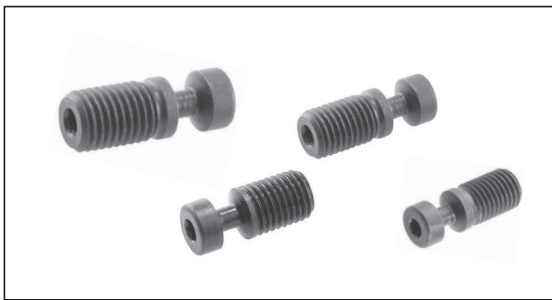

Takım Kodu Ordering Code Bestell-Bezeichnung	LEVYE VİDALARI / LEVER SCREWS / SCHRAUBEN FÜR KNIEHEBEL					Ürün Detayı / Product Detail / Produkt-Details
	a (M)	b	c	d	B	
ALV-01-M6x14	M6x1.0	14	10	5.85	2.5	P-SİSTEM için / For P-SYSTEM / FÜR P-SYSTEM S20R PCLNR/L 09, S20R PDUNR/L 11, S20R PDQNR/L 11, S20R PWNLR/L 06, S20R PTUNR/L 16
ALV-02-M6x17	M6x1.0	17	10	5.85	2.5	P-SİSTEM için / For P-SYSTEM / FÜR P-SYSTEM CNMG 09, DNMG 11, SNMG 09, TNMG 16, WNMG 06
ALV-03-M8x19	M8x1.0	19.8	11	7.9	3	P-SİSTEM için / For P-SYSTEM / FÜR P-SYSTEM CNMG 12, SNMG 12, TNMG 22, WNMG 08, DNMG 15
ALV-04-M8x22	M8x1.0	21.5	13	7.75	3	P-SİSTEM için / For P-SYSTEM / FÜR P-SYSTEM CNMG 16, SNMG 15
ALV-05-M10x27	M10x1.0	27.5	15	9.9	4	P-SİSTEM için / For P-SYSTEM / FÜR P-SYSTEM CNMG 19, SNMG 19
ALV-06-M12x36	M12x1.0	36	20	12	5	P-SİSTEM için / For P-SYSTEM / FÜR P-SYSTEM CNMG 25, SNMG 25
ALV-07-M6x13	M6x1.0	12.6	6.5	5.9	2.5	P-SİSTEM için / For P-SYSTEM / FÜR P-SYSTEM S16P PCLNR/L 09, S16P PTUNR/L 16
ALV-08-M8x16	M8x1.0	16	10	7.9	3	P-SİSTEM için / For P-SYSTEM / FÜR P-SYSTEM S25S PCLNR/L 12, S25S PDUNR/L 15, S25S PSKNR/L 12
ALV-10-M5x10	M5x0.8	10	4.6	4.9	2.5	P-SİSTEM için / For P-SYSTEM / FÜR P-SYSTEM TNMG 11

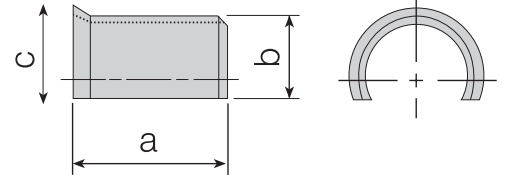

ALTIK YAYLARI / SHIM SPRINGS / BEFESTIGUNGSFEDER

Takım Kodu Ordering Code Bestell-Bezeichnung	a	b	c	Ürün Detayı / Product Detail / Produkt-Details	
				Ürün Detayı / Product Detail / Produkt-Details	Ürün Detayı / Product Detail / Produkt-Details
AA-01	5.6	4.9	6	P-SİSTEM için / For P-SYSTEM / FÜR P-SYSTEM	CNMG 09 ,DNMG 11 ,SNMG 09 ,TNMG 16 ,WNMG 06
AA-02	6	6.9	7.9	P-SİSTEM için / For P-SYSTEM / FÜR P-SYSTEM	CNMG 12 ,SNMG 12 ,TNMG 22 ,WNMG 08 ,DNMG 15
AA-03	8.9	8	9.5	P-SİSTEM için / For P-SYSTEM / FÜR P-SYSTEM	CNMG 16 ,SNMG 15
AA-04	11	9.8	10.7	P-SİSTEM için / For P-SYSTEM / FÜR P-SYSTEM	CNMG 19 ,SNMG 19
AA-05	12	13	15	P-SİSTEM için / For P-SYSTEM / FÜR P-SYSTEM	CNMG 25 ,SNMG 25
AA-07	5.6	4.9	6	P-SİSTEM için / For P-SYSTEM / FÜR P-SYSTEM	CNMG 09 ,TNMG 16

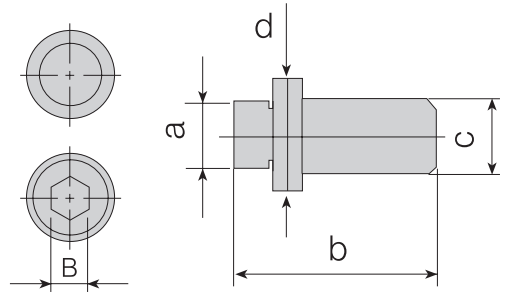
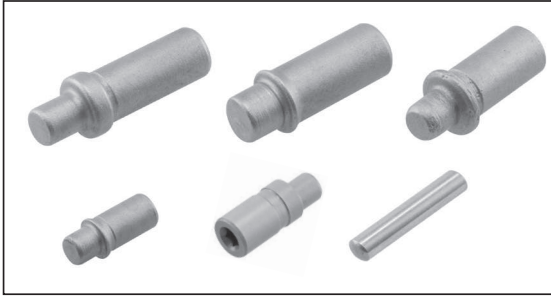

PİMLER / PINS / STIFT

Takım Kodu Ordering Code Bestell-Bezeichnung	a	b	c	d	B	Ürün Detayı / Product Detail / Produkt-Details	
						Ürün Detayı / Product Detail / Produkt-Details	Ürün Detayı / Product Detail / Produkt-Details
APM-01	3.55	18	5	6	-	M-SİSTEM için / For M-SYSTEM / FÜR M-SYSTEMM	Delik İçi / Internal / Intern Ø32-Ø40 TNMG 16 Dış Çap / External / Externe TNMG 16
APM-02	5	18	6	7.3	-	M-SİSTEM için / For M-SYSTEM / FÜR M-SYSTEMM	TNMG 22 ,WNMG 08
APM-03	3.5	12	5	6.5	-	M-SİSTEM için / For M-SYSTEM / FÜR M-SYSTEMM	S20R MTFNR/L 16 ,S20R MT-NR/L 16 ,S20R MTUNR/L 16 ,S20R MTQNR/L 16 ,S20R MDUNR/L 11
APM-04	5	15	6	7.3	-	M-SİSTEM için / For M-SYSTEM / FÜR M-SYSTEMM	S32T MCLNR/L 12 ,DNMG 15 ,S25S MWLNR/L 08
APM-05	4.50	11.5	6.5	6.5	3	M-SİSTEM için / For M-SYSTEM / FÜR M-SYSTEMM	MSYNR 11.5CS 12 Kartuş için / for Cartridge / FÜR KASSETTE
APM-06	3	15.7	-	-	-	C-SİSTEM için / For C-SYSTEM / FÜR C-SYSTEM	154.91
APM-07	3.5	11.5	6.5	6.5	3	M-SİSTEM için / For M-SYSTEM / FÜR M-SYSTEMM	S20R ET-NR 16
APM-08	3.5	12	5	5.4	-	M-SİSTEM için / For M-SYSTEM / FÜR M-SYSTEMM	S25S MWLNR/L 06 , Dış Çap / External / Externe
APM-09	3.5	10	5	5.4	-	M-SİSTEM için / For M-SYSTEM / FÜR M-SYSTEMM	S16P MWLNR/L 06
APM-10	3.5	11	5	5.4	-	M-SİSTEM için / For M-SYSTEM / FÜR M-SYSTEMM	S20R MWLNR/L 06
APM-11	3.5	11	5	6.5	-	M-SİSTEM için / For M-SYSTEM / FÜR M-SYSTEMM	S20R MTQNR/L 16
APM-12	5	12	6	7.3	-	M-SİSTEM için / For M-SYSTEM / FÜR M-SYSTEMM	S20R MCLNR/L 12 ,S25S MCLNR/L 12-Z
APM-13	5	14	6	7.3	-	M-SİSTEM için / For M-SYSTEM / FÜR M-SYSTEMM	S25S MCLNR/L 12
APM-14	3.55	15	5	6	-	M-SİSTEM için / For M-SYSTEM / FÜR M-SYSTEMM	S25S MTFNR/L 16 ,S25S MT-NR/L 16 ,S25S MTUNR/L 16,S25S MTQNR/L 16
APM-15	4.40	16	6.40	6.40	3	M-SİSTEM için / For M-SYSTEM / FÜR M-SYSTEMM	MSYNR 16CS 12 Kartuş için / for Cartridge / FÜR KASSETTE

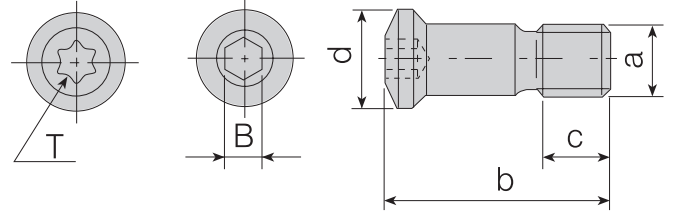

KÜRESEL FİNİŞ VİDALARI / BALL NOSE SCREWS / SCHRAUBE FÜR KUGELKOPFFRÄSER

Takım Kodu Ordering Code Bestell-Bezeichnung	a (M)	b	c	d	B(T)	Ürün Detayı / Product Detail / Produkt-Details	
1208-M3x7	M3x0.5	6.9	2.7	4.1	8	KÜRESEL FREZE VİDASI / BALL NOSE SCREW / SCHRAUBE FÜR KUGELFRÄSER	P3208
1215-M4x0.5x9	M4x0.5	8.6	3.2	5.75	15	KÜRESEL FREZE VİDASI / BALL NOSE SCREW / SCHRAUBE FÜR KUGELFRÄSER	P3210-ROHX 12
1220-M5x0.5x9	M5x0.5	9.6	3.4	6.8	20	KÜRESEL FREZE VİDASI / BALL NOSE SCREW / SCHRAUBE FÜR KUGELFRÄSER	P3212
1220-M5x0.5x12	M5x0.5	12.9	4.4	7.4	20	KÜRESEL FREZE VİDASI / BALL NOSE SCREW / SCHRAUBE FÜR KUGELFRÄSER	P3216-ROHX 16
1220-M5x0.5x15	M5x0.5	16.4	6	7.8	20	KÜRESEL FREZE VİDASI / BALL NOSE SCREW / SCHRAUBE FÜR KUGELFRÄSER	P3220-ROHX 20
1220-M6x0.75x20	M6x0.75	20	6	9.4	20	KÜRESEL FREZE VİDASI / BALL NOSE SCREW / SCHRAUBE FÜR KUGELFRÄSER	P3225
1204-M8x0.75x26	M8x0.75	26	7.5	12	4	KÜRESEL FREZE VİDASI / BALL NOSE SCREW / SCHRAUBE FÜR KUGELFRÄSER	P3232
1210-M3.5x9.6	M3.5x0.6	9.6	4	4.7	10	KÜRESEL FREZE VİDASI / BALL NOSE SCREW / SCHRAUBE FÜR KUGELFRÄSER	BNM 12
1215-M4x13.5	M4x0.7	13.5	5	5.8	15	KÜRESEL FREZE VİDASI / BALL NOSE SCREW / SCHRAUBE FÜR KUGELFRÄSER	BNM 16

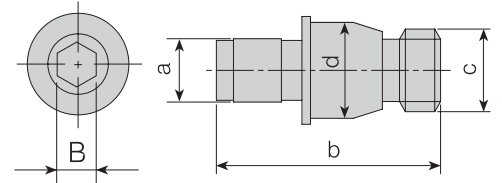
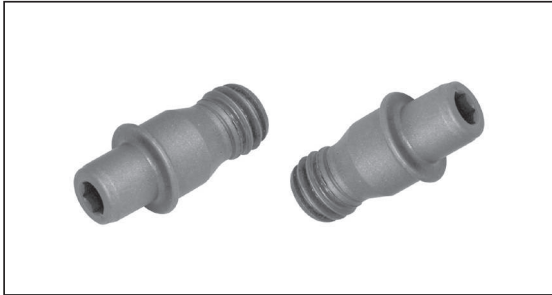

EKSANTRİK VİDA / ECCENTRIC SCREW / EXZENTERSCHRAUBEN

Takım Kodu Ordering Code Bestell-Bezeichnung	a	b	c	d	B	Ürün Detayı / Product Detail / Produkt-Details	
AEV-01-M6x16	4.85	16	M6x1.0	6.5	2.5	Eksantrik Vida / Eccentric Screw / EXZENTERSCHRAUBEN	PSDNN Kartuş için / for Cartridge / FÜR KASSETTE

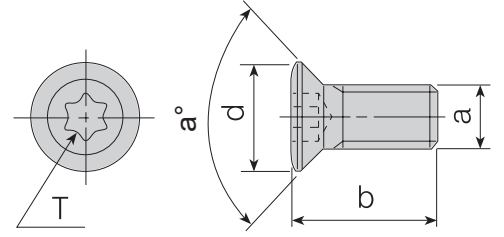

TORK VİDALARI / TORX SCREWS / TORX-SCHRAUBEN

Takım Kodu
Ordering Code
Bestell-Bezeichnung

	a (M)	b	T	d	a°	Ürün Detayı / Product Detail / Produkt-Details	
4006-M1.6x3.2	M1.6x0.35	3.2	6	2.5	60	S-SİSTEM için / For S-SYSTEM / FÜR S-SYSTEM	TORK VİDA / TORX SCREW / TORX-SCHRAUBEN
3006-M1.8x4	M1.8x0.35	4	6	2.45	60	S-SİSTEM için / For S-SYSTEM / FÜR S-SYSTEM	TORK VİDA / TORX SCREW / TORX-SCHRAUBEN
3006-M2x3.1	M2x0.4	3.1	6	2.7	60	S-SİSTEM için / For S-SYSTEM / FÜR S-SYSTEM	TORK VİDA / TORX SCREW / TORX-SCHRAUBEN
3006-M2x3.3	M2x0.4	3.3	6	2.7	60	S-SİSTEM için / For S-SYSTEM / FÜR S-SYSTEM	TORK VİDA / TORX SCREW / TORX-SCHRAUBEN
3006-M2x3.6	M2x0.4	3.6	6	2.7	60	S-SİSTEM için / For S-SYSTEM / FÜR S-SYSTEM	TORK VİDA / TORX SCREW / TORX-SCHRAUBEN
3006-M2x4	M2x0.4	4.3	6	2.7	60	S-SİSTEM için / For S-SYSTEM / FÜR S-SYSTEM	TORK VİDA / TORX SCREW / TORX-SCHRAUBEN
4006-M2x5	M2x0.4	5	6	3	55	S-SİSTEM için / For S-SYSTEM / FÜR S-SYSTEM	TORK VİDA / TORX SCREW / TORX-SCHRAUBEN
3007-M2.2x4.6	M2.2x0.45	4.6	7	3.15	60	S-SİSTEM için / For S-SYSTEM / FÜR S-SYSTEM	TORK VİDA / TORX SCREW / TORX-SCHRAUBEN
4006-M2.2x5	M2.2x0.45	5	6	2.8	55	S-SİSTEM için / For S-SYSTEM / FÜR S-SYSTEM	TORK VİDA / TORX SCREW / TORX-SCHRAUBEN
1008-M2.5x5	M2.5x0.45	5.5	8	3.5	45	S-SİSTEM için / For S-SYSTEM / FÜR S-SYSTEM	TORK VİDA / TORX SCREW / TORX-SCHRAUBEN
1008-M2.5x7	M2.5x0.45	7	8	3.6	45	S-SİSTEM için / For S-SYSTEM / FÜR S-SYSTEM	TORK VİDA / TORX SCREW / TORX-SCHRAUBEN
1108-M2.5x6	M2.5x0.45	6	8	3.9	R	S-SİSTEM için / For S-SYSTEM / FÜR S-SYSTEM	TORK VİDA / TORX SCREW / TORX-SCHRAUBEN
3008-M2.5x5	M2.5x0.45	5	8	3.5	60	S-SİSTEM için / For S-SYSTEM / FÜR S-SYSTEM	TORK VİDA / TORX SCREW / TORX-SCHRAUBEN
3008-M2.5x6	M2.5x0.45	6	8	3.5	60	S-SİSTEM için / For S-SYSTEM / FÜR S-SYSTEM	TORK VİDA / TORX SCREW / TORX-SCHRAUBEN
3008-M2.5x8	M2.5x0.45	8	8	3.5	50	S-SİSTEM için / For S-SYSTEM / FÜR S-SYSTEM	TORK VİDA / TORX SCREW / TORX-SCHRAUBEN
4008-M2.5x4	M2.5x0.45	4	8	3.5	45	S-SİSTEM için / For S-SYSTEM / FÜR S-SYSTEM	TORK VİDA / TORX SCREW / TORX-SCHRAUBEN
4008-M2.5x4.5	M2.5x0.45	4.5	8	3.5	45	S-SİSTEM için / For S-SYSTEM / FÜR S-SYSTEM	TORK VİDA / TORX SCREW / TORX-SCHRAUBEN
4008-M2.5x6	M2.5x0.45	5.8	8	3.5	45	S-SİSTEM için / For S-SYSTEM / FÜR S-SYSTEM	TORK VİDA / TORX SCREW / TORX-SCHRAUBEN
4008-M2.5x6.5	M2.5x0.45	6.5	8	4	60	S-SİSTEM için / For S-SYSTEM / FÜR S-SYSTEM	TORK VİDA / TORX SCREW / TORX-SCHRAUBEN
4108-M2.5x6.5	M2.5x0.45	6.5	8	3.5	50	S-SİSTEM için / For S-SYSTEM / FÜR S-SYSTEM	TORK VİDA / TORX SCREW / TORX-SCHRAUBEN
4108-M2.5x8	M2.5x0.45	8	8	3.5	50	S-SİSTEM için / For S-SYSTEM / FÜR S-SYSTEM	TORK VİDA / TORX SCREW / TORX-SCHRAUBEN
1008-M3x6	M3x0.5	6	8	4	60	S-SİSTEM için / For S-SYSTEM / FÜR S-SYSTEM	TORK VİDA / TORX SCREW / TORX-SCHRAUBEN
1008-M3x8	M3x0.5	8	8	3.9	60	S-SİSTEM için / For S-SYSTEM / FÜR S-SYSTEM	TORK VİDA / TORX SCREW / TORX-SCHRAUBEN
1108-M3x6.8	M3x0.5	6.8	8	4	60	S-SİSTEM için / For S-SYSTEM / FÜR S-SYSTEM	TORK VİDA / TORX SCREW / TORX-SCHRAUBEN
3008-M3x6	M3x0.5	6	8	4	45	S-SİSTEM için / For S-SYSTEM / FÜR S-SYSTEM	TORK VİDA / TORX SCREW / TORX-SCHRAUBEN
3008-M3x7	M3x0.5	7	8	4	55	S-SİSTEM için / For S-SYSTEM / FÜR S-SYSTEM	TORK VİDA / TORX SCREW / TORX-SCHRAUBEN
3008-M3x8	M3x0.5	8	8	4	45	S-SİSTEM için / For S-SYSTEM / FÜR S-SYSTEM	TORK VİDA / TORX SCREW / TORX-SCHRAUBEN
3108-M3x6	M3x0.5	6	8	3.8	60	S-SİSTEM için / For S-SYSTEM / FÜR S-SYSTEM	TORK VİDA / TORX SCREW / TORX-SCHRAUBEN
4008-M3x8	M3x0.5	8	8	4	60	S-SİSTEM için / For S-SYSTEM / FÜR S-SYSTEM	TORK VİDA / TORX SCREW / TORX-SCHRAUBEN
4010-M3x6	M3x0.5	6	10	4.2	45	S-SİSTEM için / For S-SYSTEM / FÜR S-SYSTEM	TORK VİDA / TORX SCREW / TORX-SCHRAUBEN
4010-M3x8	M3x0.5	8	10	4.2	45	S-SİSTEM için / For S-SYSTEM / FÜR S-SYSTEM	TORK VİDA / TORX SCREW / TORX-SCHRAUBEN
1015-M3.5x9	M3.5x0.6	9	15	5.3	60	S-SİSTEM için / For S-SYSTEM / FÜR S-SYSTEM	TORK VİDA / TORX SCREW / TORX-SCHRAUBEN
1015-M3.5x11	M3.5x0.6	11.1	15	5.3	60	S-SİSTEM için / For S-SYSTEM / FÜR S-SYSTEM	TORK VİDA / TORX SCREW / TORX-SCHRAUBEN
1015-M3.5x14	M3.5x0.6	14	15	5.3	66	S-SİSTEM için / For S-SYSTEM / FÜR S-SYSTEM	TORK VİDA / TORX SCREW / TORX-SCHRAUBEN
1015-M3.5x16	M3.5x0.6	16	15	5.3	55	S-SİSTEM için / For S-SYSTEM / FÜR S-SYSTEM	TORK VİDA / TORX SCREW / TORX-SCHRAUBEN
1315-M3.5x11	M3.5x0.6	10.6	15	7.9	-	S-SİSTEM için / For S-SYSTEM / FÜR S-SYSTEM	TORK VİDA / TORX SCREW / TORX-SCHRAUBEN
1510-M3.5x7	M3.5x0.6	7.1	10	5.1	55	S-SİSTEM için / For S-SYSTEM / FÜR S-SYSTEM	TORK VİDA / TORX SCREW / TORX-SCHRAUBEN
1510-M3.5x9	M3.5x0.6	9.1	10	5	55	S-SİSTEM için / For S-SYSTEM / FÜR S-SYSTEM	TORK VİDA / TORX SCREW / TORX-SCHRAUBEN
1615-M3.5x10	M3.5x0.6	10	15	5.8	60	S-SİSTEM için / For S-SYSTEM / FÜR S-SYSTEM	TORK VİDA / TORX SCREW / TORX-SCHRAUBEN
1615-M3.5x11	M3.5x0.6	11	15	5.8	60	S-SİSTEM için / For S-SYSTEM / FÜR S-SYSTEM	TORK VİDA / TORX SCREW / TORX-SCHRAUBEN
1615-M3.5x15	M3.5x0.6	15	15	5.8	60	S-SİSTEM için / For S-SYSTEM / FÜR S-SYSTEM	TORK VİDA / TORX SCREW / TORX-SCHRAUBEN
3010-M3.5x7	M3.5x0.6	7	10	5	55	S-SİSTEM için / For S-SYSTEM / FÜR S-SYSTEM	TORK VİDA / TORX SCREW / TORX-SCHRAUBEN
3010-M3.5x9	M3.5x0.6	9	10	5	55	S-SİSTEM için / For S-SYSTEM / FÜR S-SYSTEM	TORK VİDA / TORX SCREW / TORX-SCHRAUBEN
3015-M3.5x9	M3.5x0.6	8.8	15	5.4	60	S-SİSTEM için / For S-SYSTEM / FÜR S-SYSTEM	TORK VİDA / TORX SCREW / TORX-SCHRAUBEN
4015-M3.5x8	M3.5x0.6	7.9	15	5.3	55	S-SİSTEM için / For S-SYSTEM / FÜR S-SYSTEM	TORK VİDA / TORX SCREW / TORX-SCHRAUBEN
4015-M3.5x9	M3.5x0.6	8.7	15	5.3	60	S-SİSTEM için / For S-SYSTEM / FÜR S-SYSTEM	TORK VİDA / TORX SCREW / TORX-SCHRAUBEN
4015-M3.5x10	M3.5x0.6	9.8	15	5.3	60	S-SİSTEM için / For S-SYSTEM / FÜR S-SYSTEM	TORK VİDA / TORX SCREW / TORX-SCHRAUBEN

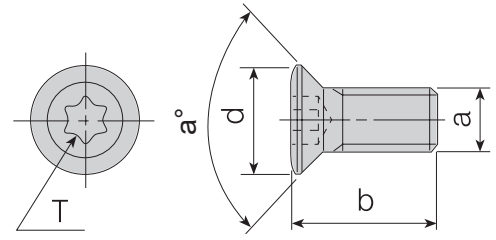

TORK VİDALARI / TORX SCREWS / TORX-SCHRAUBEN

Takım Kodu Ordering Code Bestell-Bezeichnung	a (M)	b	T	d	a°	Ürün Detayı / Product Detail / Produkt-Details	
4015-M3.5x11	M3.5x0.6	10.7	15	5.3	60	S-SİSTEM için / For S-SYSTEM / FÜR S-SYSTEM	TORK VİDA / TORX SCREW / TORX-SCHRAUBEN
4015-M3.5x12	M3.5x0.6	12	15	5.3	60	S-SİSTEM için / For S-SYSTEM / FÜR S-SYSTEM	TORK VİDA / TORX SCREW / TORX-SCHRAUBEN
4015-M3.5x14	M3.5x0.6	13.7	15	5.3	60	S-SİSTEM için / For S-SYSTEM / FÜR S-SYSTEM	TORK VİDA / TORX SCREW / TORX-SCHRAUBEN
1015-M4x8	M4x0.7	8	15	6.8	R	S-SİSTEM için / For S-SYSTEM / FÜR S-SYSTEM	TORK VİDA / TORX SCREW / TORX-SCHRAUBEN
1015-M4x9	M4x0.7	9	15	6.8	R	S-SİSTEM için / For S-SYSTEM / FÜR S-SYSTEM	TORK VİDA / TORX SCREW / TORX-SCHRAUBEN
1515-M4x9	M4x0.7	9	15	5.7	50	S-SİSTEM için / For S-SYSTEM / FÜR S-SYSTEM	TORK VİDA / TORX SCREW / TORX-SCHRAUBEN
1015-M4x11	M4x0.7	10.8	15	6.8	R	S-SİSTEM için / For S-SYSTEM / FÜR S-SYSTEM	TORK VİDA / TORX SCREW / TORX-SCHRAUBEN
1115-M4x10	M4x0.7	10	15	5.9	R	S-SİSTEM için / For S-SYSTEM / FÜR S-SYSTEM	TORK VİDA / TORX SCREW / TORX-SCHRAUBEN
1315-M4x11	M4x0.7	11.1	15	5	45	S-SİSTEM için / For S-SYSTEM / FÜR S-SYSTEM	TORK VİDA / TORX SCREW / TORX-SCHRAUBEN
1415-M4x11	M4x0.7	11	15	5.6	50	S-SİSTEM için / For S-SYSTEM / FÜR S-SYSTEM	TORK VİDA / TORX SCREW / TORX-SCHRAUBEN
1515-M4x11	M4x0.7	11.1	15	5.6	50	S-SİSTEM için / For S-SYSTEM / FÜR S-SYSTEM	TORK VİDA / TORX SCREW / TORX-SCHRAUBEN
1615-M4x11	M4x0.7	11.1	15	6	50	S-SİSTEM için / For S-SYSTEM / FÜR S-SYSTEM	TORK VİDA / TORX SCREW / TORX-SCHRAUBEN
3015-M4x9	M4x0.7	9	15	5.6	50	S-SİSTEM için / For S-SYSTEM / FÜR S-SYSTEM	TORK VİDA / TORX SCREW / TORX-SCHRAUBEN
3015-M4x11	M4x0.7	11	15	5.6	50	S-SİSTEM için / For S-SYSTEM / FÜR S-SYSTEM	TORK VİDA / TORX SCREW / TORX-SCHRAUBEN
4015-M4x8	M4x0.7	8	15	5.6	50	S-SİSTEM için / For S-SYSTEM / FÜR S-SYSTEM	TORK VİDA / TORX SCREW / TORX-SCHRAUBEN
4015-M4x9	M4x0.7	9	15	5.6	50	S-SİSTEM için / For S-SYSTEM / FÜR S-SYSTEM	TORK VİDA / TORX SCREW / TORX-SCHRAUBEN
4015-M4x10	M4x0.7	10	15	5.6	50	S-SİSTEM için / For S-SYSTEM / FÜR S-SYSTEM	TORK VİDA / TORX SCREW / TORX-SCHRAUBEN
4015-M4x11	M4x0.7	11	15	5.6	50	S-SİSTEM için / For S-SYSTEM / FÜR S-SYSTEM	TORK VİDA / TORX SCREW / TORX-SCHRAUBEN
4015-M4x12	M4x0.7	12	15	5.7	50	S-SİSTEM için / For S-SYSTEM / FÜR S-SYSTEM	TORK VİDA / TORX SCREW / TORX-SCHRAUBEN
4115-M4x12	M4x0.7	12	15	5.6	55	S-SİSTEM için / For S-SYSTEM / FÜR S-SYSTEM	TORK VİDA / TORX SCREW / TORX-SCHRAUBEN
4515-M4x8	M4x0.7	8	15	5.1	50	S-SİSTEM için / For S-SYSTEM / FÜR S-SYSTEM	TORK VİDA / TORX SCREW / TORX-SCHRAUBEN
4515-M4x11	M4x0.7	11	15	5.1	50	S-SİSTEM için / For S-SYSTEM / FÜR S-SYSTEM	TORK VİDA / TORX SCREW / TORX-SCHRAUBEN
4615-M4x11	M4x0.7	11	15	6	50	S-SİSTEM için / For S-SYSTEM / FÜR S-SYSTEM	TORK VİDA / TORX SCREW / TORX-SCHRAUBEN
1015-M4.5x12	M4.5x0.75	12	15	6.6	50	S-SİSTEM için / For S-SYSTEM / FÜR S-SYSTEM	TORK VİDA / TORX SCREW / TORX-SCHRAUBEN
1020-M4.5x14	M4.5x0.75	14	20	6.5	45	S-SİSTEM için / For S-SYSTEM / FÜR S-SYSTEM	TORK VİDA / TORX SCREW / TORX-SCHRAUBEN
1020-M4.5x16	M4.5x0.75	16	20	6.5	45	S-SİSTEM için / For S-SYSTEM / FÜR S-SYSTEM	TORK VİDA / TORX SCREW / TORX-SCHRAUBEN
1120-M4.5x12	M4.5x0.75	12.1	20	7.9	R	S-SİSTEM için / For S-SYSTEM / FÜR S-SYSTEM	TORK VİDA / TORX SCREW / TORX-SCHRAUBEN
1515-M4.5x11	M4.5x0.75	11	15	6.4	45	S-SİSTEM için / For S-SYSTEM / FÜR S-SYSTEM	TORK VİDA / TORX SCREW / TORX-SCHRAUBEN
4015-M4.5x11	M4.5x0.75	11	15	6.4	45	S-SİSTEM için / For S-SYSTEM / FÜR S-SYSTEM	TORK VİDA / TORX SCREW / TORX-SCHRAUBEN
4020-M4.5x10	M4.5x0.75	10	20	6.5	55	S-SİSTEM için / For S-SYSTEM / FÜR S-SYSTEM	TORK VİDA / TORX SCREW / TORX-SCHRAUBEN
4020-M4.5x12	M4.5x0.75	12	20	6.5	55	S-SİSTEM için / For S-SYSTEM / FÜR S-SYSTEM	TORK VİDA / TORX SCREW / TORX-SCHRAUBEN
1020-M5x7.5	M5x0.8	7.5	20	6.5	50	S-SİSTEM için / For S-SYSTEM / FÜR S-SYSTEM	TORK VİDA / TORX SCREW / TORX-SCHRAUBEN
1020-M5x11	M5x0.8	11	20	6.6	50	S-SİSTEM için / For S-SYSTEM / FÜR S-SYSTEM	TORK VİDA / TORX SCREW / TORX-SCHRAUBEN
1020-M5x14	M5x0.8	14.1	20	6.8	50	S-SİSTEM için / For S-SYSTEM / FÜR S-SYSTEM	TORK VİDA / TORX SCREW / TORX-SCHRAUBEN
1120-M5x13	M5x0.8	13	20	7	R	S-SİSTEM için / For S-SYSTEM / FÜR S-SYSTEM	TORK VİDA / TORX SCREW / TORX-SCHRAUBEN
1615-M5x14	M5x0.8	14	15	7.3	50	S-SİSTEM için / For S-SYSTEM / FÜR S-SYSTEM	TORK VİDA / TORX SCREW / TORX-SCHRAUBEN
1620-M5x18	M5x0.8	18	20	8.15	50	S-SİSTEM için / For S-SYSTEM / FÜR S-SYSTEM	TORK VİDA / TORX SCREW / TORX-SCHRAUBEN
1620-M5x22	M5x0.8	22	20	8.15	50	S-SİSTEM için / For S-SYSTEM / FÜR S-SYSTEM	TORK VİDA / TORX SCREW / TORX-SCHRAUBEN
4420-M5x14	M5x0.8	14	20	6.6	60	S-SİSTEM için / For S-SYSTEM / FÜR S-SYSTEM	TORK VİDA / TORX SCREW / TORX-SCHRAUBEN
1020-M6x16	M6x1.0	16	20	8.5	50	S-SİSTEM için / For S-SYSTEM / FÜR S-SYSTEM	TORK VİDA / TORX SCREW / TORX-SCHRAUBEN
1420-M6x16	M6x1.0	16	20	7.6	50	S-SİSTEM için / For S-SYSTEM / FÜR S-SYSTEM	TORK VİDA / TORX SCREW / TORX-SCHRAUBEN
1520-M6x16	M6x1.0	16	20	8.2	50	S-SİSTEM için / For S-SYSTEM / FÜR S-SYSTEM	TORK VİDA / TORX SCREW / TORX-SCHRAUBEN
1710-U5-40x12.2	UNC 5-40	12.2	10	5.6	60	S-SİSTEM için / For S-SYSTEM / FÜR S-SYSTEM	TORK VİDA / TORX SCREW / TORX-SCHRAUBEN
1720-U8-32x10	UNC 8-32	10	20	7.5	60	S-SİSTEM için / For S-SYSTEM / FÜR S-SYSTEM	TORK VİDA / TORX SCREW / TORX-SCHRAUBEN
1720-U8-32x15	UNC 8-32	15	20	7.5	60	S-SİSTEM için / For S-SYSTEM / FÜR S-SYSTEM	TORK VİDA / TORX SCREW / TORX-SCHRAUBEN
1707-U4-48x6	UNF 4-48	6	7	3.27	60	S-SİSTEM için / For S-SYSTEM / FÜR S-SYSTEM	TORK VİDA / TORX SCREW / TORX-SCHRAUBEN
1707-U4-48x6.5	UNF 4-48	6.5	7	3.27	60	S-SİSTEM için / For S-SYSTEM / FÜR S-SYSTEM	TORK VİDA / TORX SCREW / TORX-SCHRAUBEN
1707-U4-48x8.2	UNF 4-48	8.2	7	3.27	60	S-SİSTEM için / For S-SYSTEM / FÜR S-SYSTEM	TORK VİDA / TORX SCREW / TORX-SCHRAUBEN

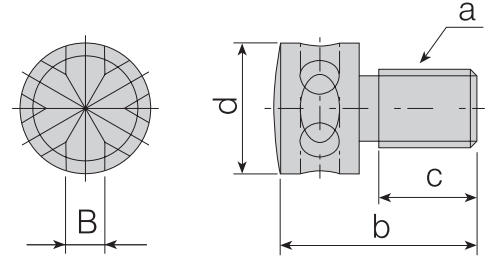

EKSENEL AYAR VİDALARI / AXIAL ADJUSTING SCREWS / AXIAL-EINSTELLSCHRAUBE

Takım Kodu Ordering Code Bestell-Bezeichnung	a (M)	b	c	d	B	Ürün Detayı / Product Detail / Produkt-Details	
2600-M4x9.5	M4x0.5	9.5	4	4	1.5	Kartuş için / for Cartridge / FÜR KASSETTE	Eksenel Ayar Vida / Axial Adjust Screw / Axial-Einstellschraube
2600-M5x13	M5x0.5	13	7	8	2.5	Kartuş için / for Cartridge / FÜR KASSETTE	Eksenel Ayar Vida / Axial Adjust Screw / Axial-Einstellschraube
2600-M6x18	M6x1.0	18	9	10	3.5	Kartuş için / for Cartridge / FÜR KASSETTE	Eksenel Ayar Vida / Axial Adjust Screw / Axial-Einstellschraube

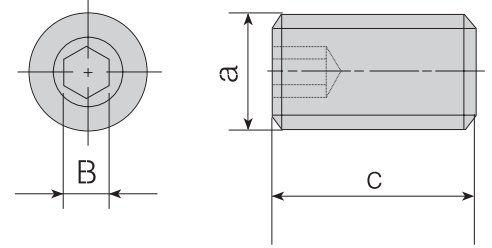
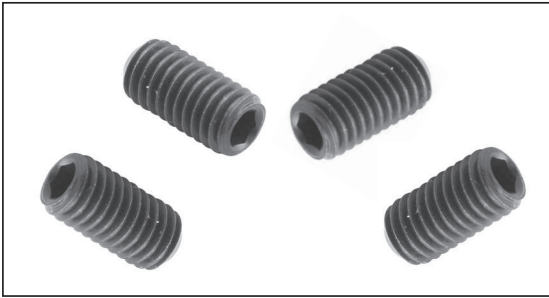

RADYAL AYAR VİDALARI / RADIAL ADJUSTING SCREWS / AXIAL-EINSTELLSCHRAUBE

Takım Kodu Ordering Code Bestell-Bezeichnung	a (M)	c	B	Ürün Detayı / Product Detail / Produkt-Details	
2715-M3x4	M3x0.5	4	1.5	KABA BARA için / for ROUGH BORING HEADS FÜR SCHRUPP-SPINDELKOPF	KABA BARA KARTUŞU için / for ROUGH BORING HEADS CARTRIDGE FÜR KASSETTEN DER SCHRUPP-SPINDELKÖPFE
2715-M3x5	M3x0.5	5	1.5	KABA BARA için / for ROUGH BORING HEADS FÜR SCHRUPP-SPINDELKOPF	KABA BARA KARTUŞU için / for ROUGH BORING HEADS CARTRIDGE FÜR KASSETTEN DER SCHRUPP-SPINDELKÖPFE
2715-M3x8	M3x0.5	8	1.5	KABA BARA için / for ROUGH BORING HEADS FÜR SCHRUPP-SPINDELKOPF	KABA BARA KARTUŞU için / for ROUGH BORING HEADS CARTRIDGE FÜR KASSETTEN DER SCHRUPP-SPINDELKÖPFE
2702-M4x4	M4x0.7	4	2	KARTUŞ için / for CARTRIDGE / FÜR KASSETTE	KARTUŞ için / for CARTRIDGE / FÜR KASSETTE
2702-M4x10	M4x0.7	10	2	KARTUŞ için / for CARTRIDGE / FÜR KASSETTE	KARTUŞ için / for CARTRIDGE / FÜR KASSETTE
2702-M4x12	M4x0.7	12	2	KABA BARA için / for ROUGH BORING HEADS FÜR SCHRUPP-SPINDELKOPF	KABA BARA KARTUŞU için / for ROUGH BORING HEADS CARTRIDGE FÜR KASSETTEN DER SCHRUPP-SPINDELKÖPFE
2725-M5x6	M5x0.8	5	2.5	KARTUŞ için / for CARTRIDGE / FÜR KASSETTE	KARTUŞ için / for CARTRIDGE / FÜR KASSETTE
2725-M5x10	M5x0.8	10	2.5	KARTUŞ için / for CARTRIDGE / FÜR KASSETTE	KARTUŞ için / for CARTRIDGE / FÜR KASSETTE
2725-M5x12	M5x0.8	12	2.5	KABA BARA için / for ROUGH BORING HEADS FÜR SCHRUPP-SPINDELKOPF	KABA BARA KARTUŞU için / for ROUGH BORING HEADS CARTRIDGE FÜR KASSETTEN DER SCHRUPP-SPINDELKÖPFE
2725-M5x14	M5x0.8	14	2.5	KABA BARA için / for ROUGH BORING HEADS FÜR SCHRUPP-SPINDELKOPF	KABA BARA KARTUŞU için / for ROUGH BORING HEADS CARTRIDGE FÜR KASSETTEN DER SCHRUPP-SPINDELKÖPFE
2703-M6x16	M6x1	16	3	KABA BARA için / for ROUGH BORING HEADS FÜR SCHRUPP-SPINDELKOPF	KABA BARA KARTUŞU için / for ROUGH BORING HEADS CARTRIDGE FÜR KASSETTEN DER SCHRUPP-SPINDELKÖPFE
2704-M8x25	M8x1.25	25.9	4	KABA BARA için / for ROUGH BORING HEADS FÜR SCHRUPP-SPINDELKOPF	KABA BARA KARTUŞU için / for ROUGH BORING HEADS CARTRIDGE FÜR KASSETTEN DER SCHRUPP-SPINDELKÖPFE
2704-M8x1x5	M8x1	5	4	İÇTEN SOĞUTMA KANALLI TAKIMLAR için / for COOLANT TOOLS / İFÜR AUSSEN-DREHHALTER	JET TAKIMLAR için / For JET TOOLS / FÜR JET WERKZEUGE
2705-G1/8x5.5	G1/8	5.5	5	İÇTEN SOĞUTMA KANALLI TAKIMLAR için / for COOLANT TOOLS / İFÜR AUSSEN-DREHHALTER	JET TAKIMLAR için / For JET TOOLS / FÜR JET WERKZEUGE

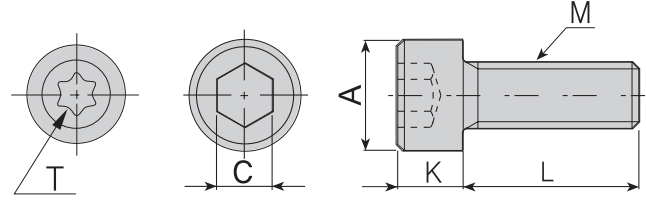

İNBUS ÇİVATALAR / INBUS SCREWS / INNENSECHSKANT-SCHRAUBE

Takım Kodu Ordering Code Bestell-Bezeichnung	M	A	C	K	L	Ürün Detayı / Product Detail / Produkt-Details	
2503-M4x10	M4x0.7	7	3	4	10	KANAL KATER VİDASI / SOME GROOVING TOOLS SCREW	SCHRAUBEN FÜR STECHHALTER
2525-M3x14	M3X0.5	5.4	2.5	3	14	BARA KARTUŞU için SIKMA VİDASI / for BORING HEADS CARTRIDGE SCREW	SCHRAUBE FÜR KASSETTE DER SCHRUPP-SPINDELKÖPFE
2503-M4x20	M4x0.7	7	3	4	20	BARA KARTUŞU için SIKMA VİDASI / for BORING HEADS CARTRIDGE SCREW	SCHRAUBE FÜR KASSETTE DER SCHRUPP-SPINDELKÖPFE
2503-M4x12	M4x0.7	7	3	4	12	KANAL KATER VİDASI / SOME GROOVING TOOLS SCREW	SCHRAUBEN FÜR STECHHALTER
2503-M4x15	M4x0.7	7	3	4	15	BARA KARTUŞU için SIKMA VİDASI / for BORING HEADS CARTRIDGE SCREW	SCHRAUBE FÜR KASSETTE DER SCHRUPP-SPINDELKÖPFE
2504-M5x16	M5x0.8	8.5	4	5	16	KANAL KATER VİDASI / SOME GROOVING TOOLS SCREW	SCHRAUBEN FÜR STECHHALTER
2504-M5x12	M5x0.8	8.5	4	5	12	KANAL KATER VİDASI / SOME GROOVING TOOLS SCREW	SCHRAUBEN FÜR STECHHALTER
2504-M5x14	M5x0.8	8.5	4	5	14	KANAL KATER VİDASI / SOME GROOVING TOOLS SCREW	SCHRAUBEN FÜR STECHHALTER
2504-M5x25	M5x0.8	8.5	4	5	25	BARA KARTUŞU için SIKMA VİDASI / for BORING HEADS CARTRIDGE SCREW	SCHRAUBE FÜR KASSETTE DER SCHRUPP-SPINDELKÖPFE
2505-M6x16	M6x1	10	5	6	16	KANAL KATER VİDASI / SOME GROOVING TOOLS SCREW	SCHRAUBEN FÜR STECHHALTER
2505-M6x20	M6x1	10	5	6	20	KANAL KATER VİDASI / SOME GROOVING TOOLS SCREW	SCHRAUBEN FÜR STECHHALTER
2505-M6x25	M6x1	10	5	6	25	BLOK BASKI PABUÇ VİDASI / for BLOCK CLAMP SCREW	SCHRAUBE FÜR SPANNBLOCK
2505-M6x30	M6x1	10	5	6	30	BARA KARTUŞU için SIKMA VİDASI / for BORING HEADS CARTRIDGE SCREW	SCHRAUBE FÜR KASSETTE DER SCHRUPP-SPINDELKÖPFE
2306-M8x37	M8x1.25	13	6	6.4	31.5	MONTAJ VİDASI (KAFASI KÜÇÜK) / MOUNTING SCREW (SMALL HEAD)	BEFESTIGUNGSSCHRAUBE
2405-M8x30	M8x1.25	13	5	5	30	A16 MONTAJ VİDASI (KAFASI KÜÇÜK) / MOUNTING SCREW (SMALL HEAD)	BEFESTIGUNGSSCHRAUBE (KLEINER KOPF)
2506-M8x20	M8x1.25	13	6	8	20	KARTUŞ MONTAJ VİDASI / CARTRIDGE MOUNTING SCREW	BEFESTIGUNGSSCHRAUBE FÜR KASSETTE
2506-M8x30	M8x1.25	13	6	8	30	A16 MONTAJ VİDASI / MOUNTING SCREW	BEFESTIGUNGSSCHRAUBE
2506-M8x35	M8x1.25	13	6	8	35	BARA KARTUŞU için SIKMA VİDASI / for BORING HEADS CARTRIDGE SCREW	SCHRAUBE FÜR KASSETTE DER SCHRUPP-SPINDELKÖPFE
2406-M8x30	M8x1.25	12	6	8	30	A16 MONTAJ VİDASI / MOUNTING SCREW	BEFESTIGUNGSSCHRAUBE
2407-M10x30	M10x1.5	16	7	6	30	A16 MONTAJ VİDASI / MOUNTING SCREW	BEFESTIGUNGSSCHRAUBE
2408-M10x30	M10x1.5	13	8	10	30	A22 MONTAJ VİDASI / MOUNTING SCREW	BEFESTIGUNGSSCHRAUBE
2508-M10x30	M10x1.5	16	8	10	30	A22 MONTAJ VİDASI / MOUNTING SCREW	BEFESTIGUNGSSCHRAUBE
2508-M10x40	M10x1.5	16	8	10	40	BARA KARTUŞU için SIKMA VİDASI / for BORING HEADS CARTRIDGE SCREWS	SCHRAUBE FÜR KASSETTE DER SCHRUPP-SPINDELKÖPFE
2408-M12x35	M12x1.75	18	8	7	35	A27 MONTAJ VİDASI / MOUNTING SCREW	BEFESTIGUNGSSCHRAUBE
2510-M12x35	M12x1.75	18	10	12	35	A27 MONTAJ VİDASI / MOUNTING SCREW	BEFESTIGUNGSSCHRAUBE
2514-M16x35	M16x2.0	23.7	14	16	35	A32 MONTAJ VİDASI / MOUNTING SCREW	BEFESTIGUNGSSCHRAUBE
AAV-11-U5-40x4.5	UNC 5-40	5.4	T10	2.8	4.5	16 ER/L, 16 IR/L ALTLIK VİDASI / SHIM SCREW	SCHRAUBE FÜR UNTERLAGE
AAV-12-U8-32x5.5	UNC 8-32	6.7	T20	3.8	5.5	22 ER/L, 22 IR/L ALTLIK VİDASI / SHIM SCREW	SCHRAUBE FÜR UNTERLAGE
AAV-15-M5x5.7	M5X0.8	8.5	T20	3.15	5.7	27 ER/L, 27 IR/L ALTLIK VİDASI / SHIM SCREW	SCHRAUBE FÜR UNTERLAGE

SEGMAN / RING / RING

Ürün Resmi Product Picture Produkt-Bild	Ürün Kodu Product Code / Code	Ürün Detayı / Product Detail / Produkt-Details	
	ACS-01	C-SİSTEM için / For C-SYSTEM / FÜR C-SYSTEM	TNGN, CNGN, DNGN, SNGN SEGMANI / RING
	AS-01	T-M-SİSTEM için / For T-M-SYSTEM / FÜR T-M-SYSTEM	AKV-30-M6x22 SEGMANI / RING
	AS-02	T SİSTEM için / For T SYSTEM / FÜR T-SYSTEM	AKV-19-M7x25 SEGMANI / RING

ORING / ORING / ORING

Ürün Resmi
Product Picture
Produkt-Bild



Ürün Kodu
Product Code / Code

Ürün Detayı / Product Detail / Produkt-Details

AOR-01	P-SİSTEM için / For P-SYSTEM / FÜR P-SYSTEM	ORING
AXR-01	T-P SİSTEM için / For T-P SYSTEM / TFÜR P-SYSTEM	ORING

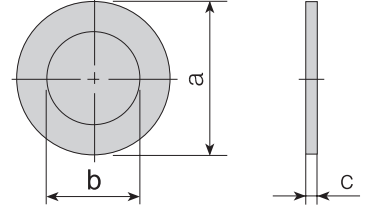
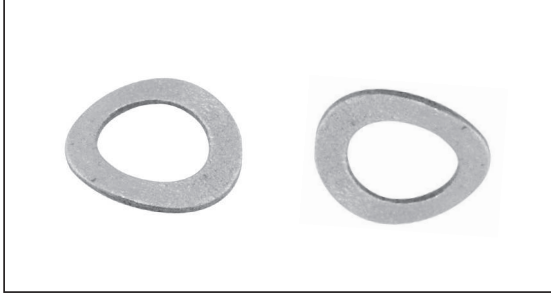

BASKI VE ALTLIK VİDASI PULU / STAMP / UNTERLEGSCHIEBE

Takım Kodu
Ordering Code
Bestell-Bezeichnung

a b c Ürün Detayı / Product Detail / Produkt-Details

Takım Kodu Ordering Code Bestell-Bezeichnung	a	b	c	Ürün Detayı / Product Detail / Produkt-Details
ABPL-01	10.5	6.2	0.5	PUL/STAMP/RING BASKI PULU / STAMP / RING
ABPL-02	12.75	7.1	0.45	PUL/STAMP/RING BASKI PULU / STAMP / RING
ABPL-03	5.3	3.2	0.5	PUL/STAMP/RING TER - TIR 16 ER/EL - IR/IL ALTLIK VİDASI PULU / SHIM SCREW RING / SHIM SCREW RING / SCHRAUBE FÜR UNTERLAGENRING
ABPL-04	6.9	4.2	0.5	PUL/STAMP/RING TER - TIR 22 ER/EL - IR/IL ALTLIK VİDASI PULU / SHIM SCREW RING / SHIM SCREW RING / SCHRAUBE FÜR UNTERLAGENRING
ABPL-05	8.5	5	0.5	PUL/STAMP/RING TER - TIR 27 ER/EL - IR/IL ALTLIK VİDASI PULU / SHIM SCREW RING / SHIM SCREW RING / SCHRAUBE FÜR UNTERLAGENRING

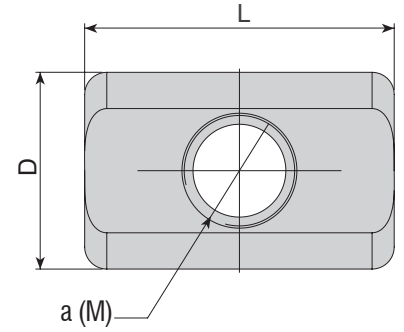

BARA PABUÇLARI / BORING HEADS CARTRIDGE / KASSETTE FÜR SPINDELKOPF

Takım Kodu
Ordering Code
Bestell-Bezeichnung

a (M) D L Ürün Detayı / Product Detail / Produkt-Details

Takım Kodu Ordering Code Bestell-Bezeichnung	a (M)	D	L	Ürün Detayı / Product Detail / Produkt-Details
ABKS-D16	M3x0.5	4.9	6	KABA BARA için / for ROUGH BORING HEADS / FÜR SCHRUPP-SPINDELKOPF ABHR-D16x42-W16-L90
ABKS-D20	M4x0.7	5.9	9	ABA BARA için / for ROUGH BORING HEADS / FÜR SCHRUPP-SPINDELKOPF ABHR-D20x50-W20-L100
ABKS-D25	M4x0.7	5.9	12	KABA BARA için / for ROUGH BORING HEADS / FÜR SCHRUPP-SPINDELKOPF ABHR-D25x60-W20-L110
ABKS-D32	M5x0.8	8.9	14	KABA BARA için / for ROUGH BORING HEADS / FÜR SCHRUPP-SPINDELKOPF ABHR-D32x64-W25-L120
ABKS-D40	M6x1	10.9	18	KABA BARA için / for ROUGH BORING HEADS / FÜR SCHRUPP-SPINDELKOPF ABHR-D40x80-W32-L140
ABKS-D50	M8x1.25	13.9	28	KABA BARA için / for ROUGH BORING HEADS / FÜR SCHRUPP-SPINDELKOPF ABHR-D50x100-W32-L160
ABKS-D63	M10x1.5	15.9	35	KABA BARA için / for ROUGH BORING HEADS / FÜR SCHRUPP-SPINDELKOPF ABHR-D63x80-W32-L140, ABHR-D63x130-W40-L200
ABKS-D80	M12x1.75	17.9	45	KABA BARA için / for ROUGH BORING HEADS / FÜR SCHRUPP-SPINDELKOPF ABHR-D80x140-W40-L210, ABHR-D80x140-W40-L210-B



Ürün Resmi Product Picture Produkt-Bild	KESME ve KANAL LAMA AÇMA BLOK PABUÇLARI / BLOCKS FOR PARTING AND DEEP GROOVING BLADES CLAMPS KLEMMLEISTE FÜR SCHWERT-SPANNBLOCK		
	Ürün Kodu Product Code / Code	Ürün Detayı / Product Detail / Produkt-Details	
	ABK-01	LAMA BLOĞU için / For BLADE BLOCK / FÜR SCHWERT-SPANNBLOCK	ALBU-20-26 BASKI PABUCU / CLAMP / PRATZE
	ABK-02	LAMA BLOĞU için / For BLADE BLOCK / FÜR SCHWERT-SPANNBLOCK	ALBU-25-26 BASKI PABUCU / CLAMP / PRATZE
	ABK-03	LAMA BLOĞU için / For BLADE BLOCK / FÜR SCHWERT-SPANNBLOCK	ALBU-20-32 BASKI PABUCU / CLAMP / PRATZE
	ABK-04	LAMA BLOĞU için / For BLADE BLOCK / FÜR SCHWERT-SPANNBLOCK	ALBU-25-32, ALBU-32-32 BASKI PABUCU / CLAMP / PRATZE

Ürün Resmi Product Picture Produkt-Bild	LAMA ANAHTARI / BLADE KEY / SCHWERT-SCHLÜSSEL		
	Ürün Kodu Product Code / Code	Ürün Detayı / Product Detail / Produkt-Details	
	ALA-01	AKL LAMA ANAHTARI / for BLADE KEY / SCHWERT-SCHLÜSSEL	
	ALA-02	AKL LAMA ANAHTARI / for BLADE KEY / SCHWERT-SCHLÜSSEL	

Ürün Resmi Product Picture Produkt-Bild	ALYAN ANAHTARLARI / ALLEN KEYS / INNENSECHSKANT-SCHLÜSSEL		
	Ürün Kodu Product Code / Code	Ürün Detayı / Product Detail / Produkt-Details	
	AAL-01-2	2 mm	ALYAN ANAHTARI / ALLEN KEYS / INNENSECHSKANT-SCHLÜSSEL
	AAL-02-2.5	2.5 mm	ALYAN ANAHTARI / ALLEN KEYS / INNENSECHSKANT-SCHLÜSSEL
	AAL-03-3	3 mm	ALYAN ANAHTARI / ALLEN KEYS / INNENSECHSKANT-SCHLÜSSEL
	AAL-05-4	4 mm	ALYAN ANAHTARI / ALLEN KEYS / INNENSECHSKANT-SCHLÜSSEL
	AAL-07-5	5 mm	ALYAN ANAHTARI / ALLEN KEYS / INNENSECHSKANT-SCHLÜSSEL
	AAL-08-6	6 mm	ALYAN ANAHTARI / ALLEN KEYS / INNENSECHSKANT-SCHLÜSSEL
	AAL-09-1.5	1.5 mm	ALYAN ANAHTARI / ALLEN KEYS / INNENSECHSKANT-SCHLÜSSEL
	AAL-11-8	8 mm	ALYAN ANAHTARI / ALLEN KEYS / INNENSECHSKANT-SCHLÜSSEL
	AAL-12-10	10 mm	ALYAN ANAHTARI / ALLEN KEYS / INNENSECHSKANT-SCHLÜSSEL

Ürün Resmi Product Picture Produkt-Bild	TORK ANAHTARLARI / TORX KEYS / TORX-SCHLÜSSEL		
	Ürün Kodu Product Code / Code	Ürün Detayı / Product Detail / Produkt-Details	
	82-T06	T06 TORK ANAHTARI / TORX KEY / TORX-SCHLÜSSEL	
	82-T07	T07 TORK ANAHTARI / TORX KEY / TORX-SCHLÜSSEL	
	82-T08	T08 TORK ANAHTARI / TORX KEY / TORX-SCHLÜSSEL	
	82-T10	T10 TORK ANAHTARI / TORX KEY / TORX-SCHLÜSSEL	
	80-T15	T15 TORK ANAHTARI / TORX KEY / TORX-SCHLÜSSEL	
	80-T20	T20 TORK ANAHTARI / TORX KEY / TORX-SCHLÜSSEL	
	81-T15	T15 T-TİP TORK ANAHTARI / T-TYPE TORX KEY / T-TYP-TORX-SCHLÜSSEL	
	81-T20	T20 T-TİP TORK ANAHTARI / T-TYPE TORX KEY / T-TYP-TORX-SCHLÜSSEL	



KONUŞULAN KALİTE

THE SPOKEN QUALITY

QUALITÄT ÜBER DIE MAN SPRICHT

www.akko.com.tr



TS EN ISO 9001:2015





WEB SİTESİ YENİLENDİ! OUR WEBSITE RENEWED! UNSERE WEBSITE ERNEUERT!



Geleceğe şekil veren çözümler için E-Bülten'e abone olun!
Subscribe to our e-bulletin for solutions that shape the future!
Abonnieren Sie unser E-Bulletin für Lösungen, die die Zukunft gestalten



www.akko.com.tr

Search

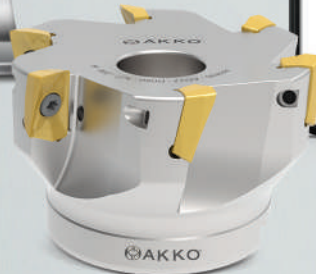
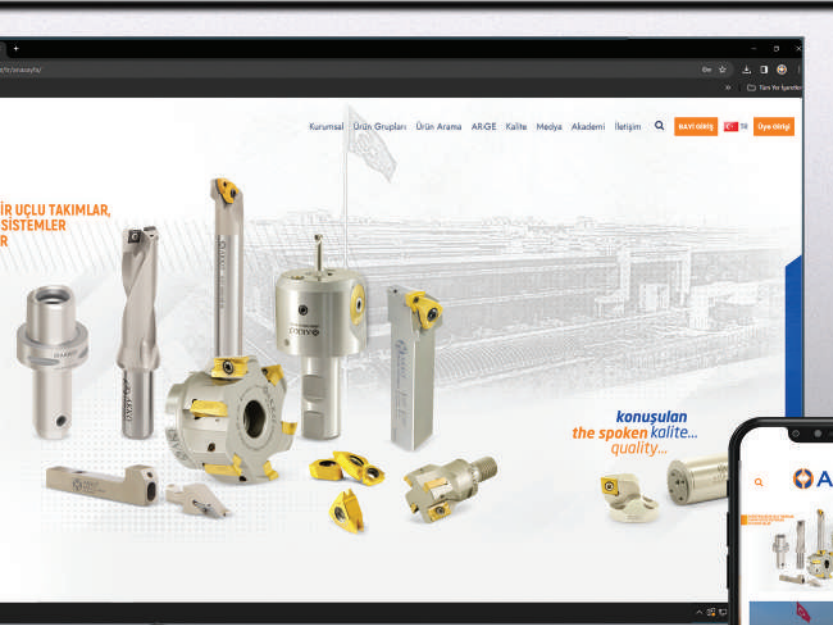

TS EN ISO 9001:2015



konusulan
the spoken *kalite...*
quality...

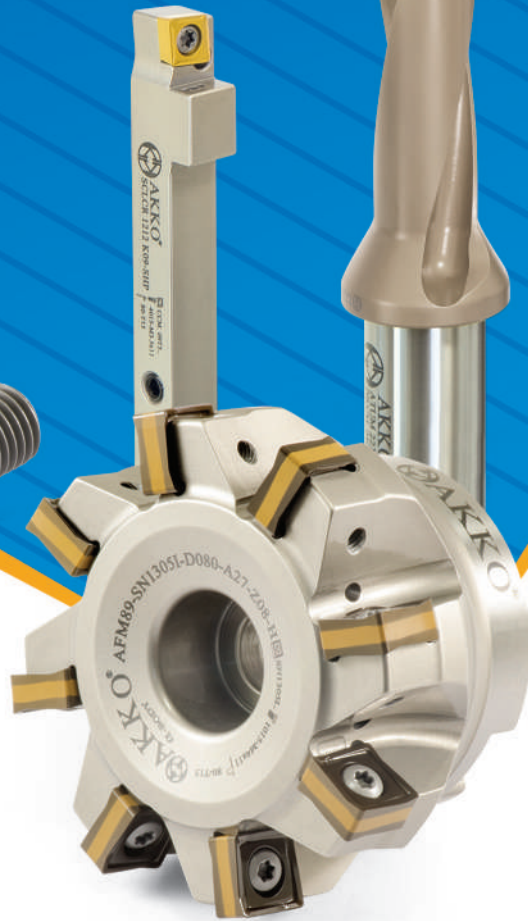

www.akkocom.tr

AKKO®
ADKT-H22-R-2525-(0.5-2)-T6
AKK-01 AKY-01 AAL-01-1

konusulan
the spoken **kalite...**
quality...







THE SPOKEN QUALITY

Değiştirilebilir Uçlu Takımlar, Takım Tutucu Sistemler ve Kesici Uçlar
Indexable Tools, Tool Holder Systems and Cutting Inserts
Zerspanungswerkzeuge, Werkzeugaufnahmen und Zerspannungswerkzeuge

www.akko.com.tr



Konya 5. Organize Sanayi Bölgesi
Aşağıpınarbaşı Osb Mh. 526 Nolu Sk. No:1
Setçuklu / KONYA / TÜRKİYE

Tel : +90 332 239 17 57 (pbx)
Fax : +90 332 239 17 52
GPS : 38.005409, 32.635734

www.akko.com.tr
akko@akko.com.tr
export@akko.com.tr



    AKKO Metalworking Tools

Yenilikler için bizi takip edin!
Follow us for news!
Für Neuheiten bitte uns folgen